



ROYAL CANADIAN ARMY CADETS

GOLD STAR INSTRUCTIONAL GUIDES

(ENGLISH)

(Supersedes A-CR-CCP-704/PF-001 dated 2010-09-01)

Cette publication est disponible en français sous le numéro A-CR-CCP-704/PF-002.

Issued on Authority of the Chief of the Defence Staff

Canada



NOTICE

This documentation has been reviewed by the technical authority and does not contain controlled goods. Disclosure notices and handling instructions originally received with the document shall continue to apply.

AVIS

Cette documentation a été révisée par l'autorité technique et ne contient pas de marchandises contrôlées. Les avis de divulgation et les instructions de manutention reçues originalement doivent continuer de s'appliquer.



ROYAL CANADIAN ARMY CADETS

GOLD STAR INSTRUCTIONAL GUIDES

(ENGLISH)

(Supersedes A-CR-CCP-704/PF-001 dated 2010-09-01)

Cette publication est disponible en français sous le numéro A-CR-CCP-704/PF-002.

Issued on Authority of the Chief of the Defence Staff

**OPI: D Cdts & JCR 4 – Senior Staff Officer Cadet Programs
Development**

2015-09-01

Canada



NOTICE

This documentation has been reviewed by the technical authority and does not contain controlled goods. Disclosure notices and handling instructions originally received with the document shall continue to apply.

AVIS

Cette documentation a été révisée par l'autorité technique et ne contient pas de marchandises contrôlées. Les avis de divulgation et les instructions de manutention reçues originalement doivent continuer de s'appliquer.

LIST OF EFFECTIVE PAGES

Insert latest changed pages and dispose of superseded pages in accordance with applicable orders.

NOTE

The portion of the text affected by the latest change is indicated by a black vertical line in the margin of the page. Changes to illustrations are indicated by miniature pointing hands or black vertical lines.

Dates of issue for original and changed pages are:

| | | | | |
|---------------|---|------------|---------|---|
| Original..... | 0 | 2015-09-01 | Ch..... | 3 |
| Ch..... | 1 | | Ch..... | 4 |
| Ch..... | 2 | | Ch..... | 5 |

Zero in Change No. column indicates an original page. Total number of pages in this publication is 1203 consisting of the following:

| Page No. | Change No. | Page No. | Change No. |
|-------------------------------|-------------------|---------------------------------|-------------------|
| Cover page..... | 0 | M403.06B-1 to M403.06B-6..... | 0 |
| Title..... | 0 | C403.01-1 to C403.01-4..... | 0 |
| A to E..... | 0 | C403.01A-1 to C403.01A-2..... | 0 |
| i to x..... | 0 | C403.01B-1 to C403.01B-10..... | 0 |
| 400-1 to 400-2..... | 0 | C403.01B1-1 to C403.01B1-2..... | 0 |
| X01-1 to X01-2..... | 0 | C403.01B2-1 to C403.01B2-2..... | 0 |
| X02-1 to X02-2..... | 0 | C403.01B3-1 to C403.01B3-2..... | 0 |
| M403.01-1 to M403.01-8..... | 0 | C403.01B4-1 to C403.01B4-2..... | 0 |
| M403.01A-1 to M403.01A-2..... | 0 | C403.01B5-1 to C403.01B5-4..... | 0 |
| M403.02-1 to M403.02-12..... | 0 | C403.01B6-1 to C403.01B6-2..... | 0 |
| M403.02A-1 to M403.02A-2..... | 0 | C403.01C-1 to C403.01C-10..... | 0 |
| M403.02B-1 to M403.02B-4..... | 0 | C403.01C1-1 to C403.01C1-2..... | 0 |
| M403.02C-1 to M403.02C-2..... | 0 | C403.01D-1 to C403.01D-8..... | 0 |
| M403.02D-1 to M403.02D-2..... | 0 | C403.01D1-1 to C403.01D1-2..... | 0 |
| M403.03-1 to M403.03-8..... | 0 | C403.01D2-1 to C403.01D2-2..... | 0 |
| M403.03A-1 to M403.03A-2..... | 0 | C403.01D3-1 to C403.01D3-2..... | 0 |
| M403.03B-1 to M403.03B-2..... | 0 | C403.01E-1 to C403.01E-6..... | 0 |
| M403.03C-1 to M403.03C-2..... | 0 | C403.01E1-1 to C403.01E1-2..... | 0 |
| M403.04-1 to M403.04-10..... | 0 | C403.01E2-1 to C403.01E2-2..... | 0 |
| M403.04A-1 to M403.04A-2..... | 0 | C403.02-1 to C403.02-10..... | 0 |
| M403.04B-1 to M403.04B-4..... | 0 | C403.02A-1 to C403.02A-14..... | 0 |
| M403.05-1 to M403.05-12..... | 0 | X04-1 to X04-2..... | 0 |
| M403.05A-1 to M403.05A-2..... | 0 | X05-1 to X05-2..... | 0 |
| M403.05B-1 to M403.05B-2..... | 0 | M406.01-1 to M406.01-6..... | 0 |
| M403.05C-1 to M403.05C-2..... | 0 | M406.01A-1 to M406.01A-2..... | 0 |
| M403.06-1 to M403.06-10..... | 0 | M406.01B-1 to M406.01B-2..... | 0 |
| M403.06A-1 to M403.06A-6..... | 0 | M406.01C-1 to M406.01C-2..... | 0 |

LIST OF EFFECTIVE PAGES (Cont)

| Page No. | Change No. | Page No. | Change No. |
|-------------------------------|------------|-------------------------------|------------|
| M406.01D-1 to M406.01D-2..... | 0 | C407.01C-1 to C407.01C-2..... | 0 |
| M406.01E-1 to M406.01E-2..... | 0 | C407.01D-1 to C407.01D-2..... | 0 |
| M406.01F-1 to M406.01F-2..... | 0 | M408.01-1 to M408.01-6..... | 0 |
| M406.01G-1 to M406.01G-2..... | 0 | M408.02-1 to M408.02-10..... | 0 |
| M406.01H-1 to M406.01H-2..... | 0 | M408.03-1 to M408.03-12..... | 0 |
| M406.01I-1 to M406.01I-2..... | 0 | M408.03A-1 to M408.03A-2..... | 0 |
| M406.01J-1 to M406.01J-2..... | 0 | M408.04-1 to M408.04-6..... | 0 |
| C406.01-1 to C406.01-8..... | 0 | M408.04A-1 to M408.04A-2..... | 0 |
| C406.01A-1 to C406.01A-4..... | 0 | M408.04B-1 to M408.04B-4..... | 0 |
| C406.02-1 to C406.02-10..... | 0 | M408.04C-1 to M408.04C-2..... | 0 |
| C406.02A-1 to C406.02A-2..... | 0 | C408.01-1 to C408.01-8..... | 0 |
| C406.02B-1 to C406.02B-2..... | 0 | C408.01A-1 to C408.01A-2..... | 0 |
| C406.02C-1 to C406.02C-2..... | 0 | C408.02-1 to C408.02-2..... | 0 |
| C406.02D-1 to C406.02D-2..... | 0 | M409.01-1 to M409.01-10..... | 0 |
| M407.01-1 to M407.01-12..... | 0 | M409.01A-1 to M409.01A-2..... | 0 |
| M407.01A-1 to M407.01A-6..... | 0 | M409.01B-1 to M409.01B-2..... | 0 |
| M407.02-1 to M407.02-10..... | 0 | M409.01C-1 to M409.01C-8..... | 0 |
| M407.03-1 to M407.03-10..... | 0 | M409.01D-1 to M409.01D-6..... | 0 |
| M407.03A-1 to M407.03A-2..... | 0 | M409.01E-1 to M409.01E-6..... | 0 |
| M407.03B-1 to M407.03B-2..... | 0 | M409.01F-1 to M409.01F-2..... | 0 |
| M407.03C-1 to M407.03C-2..... | 0 | M409.01G-1 to M409.01G-2..... | 0 |
| M407.03D-1 to M407.03D-2..... | 0 | M409.01H-1 to M409.01H-2..... | 0 |
| M407.03E-1 to M407.03E-2..... | 0 | M409.02-1 to M409.02-16..... | 0 |
| M407.03F-1 to M407.03F-2..... | 0 | M409.02A-1 to M409.02A-4..... | 0 |
| M407.03G-1 to M407.03G-2..... | 0 | M409.02B-1 to M409.02B-2..... | 0 |
| M407.03H-1 to M407.03H-2..... | 0 | M409.02C-1 to M409.02C-2..... | 0 |
| M407.03I-1 to M407.03I-2..... | 0 | M409.03-1 to M409.03-14..... | 0 |
| M407.03J-1 to M407.03J-2..... | 0 | M409.03A-1 to M409.03A-2..... | 0 |
| M407.03K-1 to M407.03K-2..... | 0 | M409.03B-1 to M409.03B-2..... | 0 |
| M407.03L-1 to M407.03L-2..... | 0 | M409.03C-1 to M409.03C-4..... | 0 |
| M407.03M-1 to M407.03M-2..... | 0 | M409.03D-1 to M409.03D-2..... | 0 |
| M407.03N-1 to M407.03N-2..... | 0 | M409.03E-1 to M409.03E-2..... | 0 |
| M407.03O-1 to M407.03O-2..... | 0 | M409.03F-1 to M409.03F-2..... | 0 |
| M407.03P-1 to M407.03P-2..... | 0 | M409.03G-1 to M409.03G-2..... | 0 |
| M407.03Q-1 to M407.03Q-2..... | 0 | M409.03H-1 to M409.03H-2..... | 0 |
| M407.03R-1 to M407.03R-2..... | 0 | M409.03I-1 to M409.03I-2..... | 0 |
| M407.03S-1 to M407.03S-2..... | 0 | M409.03J-1 to M409.03J-2..... | 0 |
| M407.03T-1 to M407.03T-2..... | 0 | M409.03K-1 to M409.03K-2..... | 0 |
| M407.03U-1 to M407.03U-2..... | 0 | M409.03L-1 to M409.03L-2..... | 0 |
| C407.01-1 to C407.01-10..... | 0 | M409.04-1 to M409.04-6..... | 0 |
| C407.01A-1 to C407.01A-2..... | 0 | M409.04A-1 to M409.04A-4..... | 0 |
| C407.01B-1 to C407.01B-2..... | 0 | M409.04B-1 to M409.04B-4..... | 0 |

LIST OF EFFECTIVE PAGES (Cont)

| Page No. | Change No. | Page No. | Change No. |
|-------------------------------|------------|--------------------------------|------------|
| M409.04C-1 to M409.04C-2..... | 0 | C422.05-1 to C422.05-6..... | 0 |
| M409.04D-1 to M409.04D-2..... | 0 | C422.05A-1 to C422.05A-2..... | 0 |
| M409.04E-1 to M409.04E-2..... | 0 | C422.06-1 to C422.06-12..... | 0 |
| M409.05-1 to M409.05-2..... | 0 | M424.01-1 to M424.01-18..... | 0 |
| C409.01-1 to C409.01-2..... | 0 | M424.02-1 to M424.02-8..... | 0 |
| C409.02-1 to C409.02-2..... | 0 | M424.02A-1 to M424.02A-2..... | 0 |
| C409.03-1 to C409.03-4..... | 0 | M424.03-1 to M424.03-18..... | 0 |
| C409.04-1 to C409.04-12..... | 0 | C424.01-1 to C424.01-14..... | 0 |
| C409.04A-1 to C409.04A-2..... | 0 | C424.01A-1 to C424.01A-6..... | 0 |
| C409.04B-1 to C409.04B-2..... | 0 | C424.02-1 to C424.02-14..... | 0 |
| C409.04C-1 to C409.04C-4..... | 0 | C424.03-1 to C424.03-12..... | 0 |
| C409.04D-1 to C409.04D-2..... | 0 | C424.04-1 to C424.04-10..... | 0 |
| C409.04E-1 to C409.04E-2..... | 0 | M425.01-1 to M425.01-10..... | 0 |
| C409.04F-1 to C409.04F-2..... | 0 | M425.01A-1 to M425.01A-6..... | 0 |
| C409.04G-1 to C409.04G-2..... | 0 | M425.01B-1 to M425.01B-2..... | 0 |
| C409.04H-1 to C409.04H-2..... | 0 | M425.01C-1 to M425.01C-2..... | 0 |
| C409.04I-1 to C409.04I-2..... | 0 | M425.01D-1 to M425.01D-4..... | 0 |
| C409.04J-1 to C409.04J-2..... | 0 | M425.02-1 to M425.02-18..... | 0 |
| C409.04K-1 to C409.04K-2..... | 0 | M425.02A-1 to M425.02A-12..... | 0 |
| C409.04L-1 to C409.04L-2..... | 0 | M425.02B-1 to M425.02B-4..... | 0 |
| C409.04M-1 to C409.04M-2..... | 0 | M425.02C-1 to M425.02C-4..... | 0 |
| C409.05-1 to C409.05-6..... | 0 | M425.02D-1 to M425.02D-6..... | 0 |
| C409.06-1 to C409.06-6..... | 0 | M425.02E-1 to M425.02E-2..... | 0 |
| C409.06A-1 to C409.06A-2..... | 0 | M425.02F-1 to M425.02F-8..... | 0 |
| X20-1 to X20-2..... | 0 | M425.02G-1 to M425.02G-2..... | 0 |
| M422.01-1 to M422.01-6..... | 0 | M425.02H-1 to M425.02H-14..... | 0 |
| M422.01A-1 to M422.01A-4..... | 0 | M425.03-1 to M425.03-4..... | 0 |
| M422.01B-1 to M422.01B-4..... | 0 | M425.03A-1 to M425.03A-4..... | 0 |
| M422.01C-1 to M422.01C-8..... | 0 | M425.03B-1 to M425.03B-4..... | 0 |
| M422.01D-1 to M422.01D-4..... | 0 | M425.04-1 to M425.04-14..... | 0 |
| M422.01E-1 to M422.01E-6..... | 0 | M425.04A-1 to M425.04A-6..... | 0 |
| M422.02-1 to M422.02-20..... | 0 | M425.04B-1 to M425.04B-2..... | 0 |
| M422.03-1 to M422.03-14..... | 0 | M425.04C-1 to M425.04C-4..... | 0 |
| M422.03A-1 to M422.03A-2..... | 0 | M425.04D-1 to M425.04D-4..... | 0 |
| C422.01-1 to C422.01-6..... | 0 | M425.04E-1 to M425.04E-4..... | 0 |
| C422.01A-1 to C422.01A-2..... | 0 | C425.01-1 to C425.01-18..... | 0 |
| C422.02-1 to C422.02-14..... | 0 | C425.02-1 to C425.02-6..... | 0 |
| C422.02A-1 to C422.02A-2..... | 0 | C425.02A-1 to C425.02A-2..... | 0 |
| C422.03-1 to C422.03-6..... | 0 | C425.02B-1 to C425.02B-12..... | 0 |
| C422.04-1 to C422.04-16..... | 0 | M426.01-1 to M426.01-14..... | 0 |
| C422.04A-1 to C422.04A-2..... | 0 | M426.01A-1 to M426.01A-6..... | 0 |
| C422.04B-1 to C422.04B-2..... | 0 | M426.01B-1 to M426.01B-2..... | 0 |

LIST OF EFFECTIVE PAGES (Cont)

| Page No. | Change No. | Page No. | Change No. |
|--------------------------------|-------------------|---------------------------------|-------------------|
| M426.02a-1 to M426.02a-34..... | 0 | M426.02e-1 to M426.02e-32..... | 0 |
| M426.02b-1 to M426.02b-34..... | 0 | M426.02eA-1 to M426.02eA-2..... | 0 |
| M426.02c-1 to M426.02c-24..... | 0 | | |
| M426.02d-1 to M426.02d-18..... | 0 | | |

Contact Officer: D Cdts & JCR 4-7-3 – Army Cadet Program Development Staff Officer

© 2015 DND/MDN Canada

THIS PAGE INTENTIONALLY LEFT BLANK

FOREWORD AND PREFACE

1. **Issuing Authority.** This Instructional Guide (IG) A-CR-CCP-704/PF-001 was developed under the authority of the Director Cadets and Junior Canadian Rangers, and issued on the authority of the Chief of Defence Staff.
2. **Development.** Development of this IG was in accordance with the performance oriented concept of training outlined in the A-P9-050 Series, Canadian Forces Individual Training and Education System, with modifications to meet the needs of the Canadian Cadet Organizations.
3. **Purpose of the IG.** The IG is to be used by Royal Canadian Army Cadet Corps in conjunction with other resources to conduct the Gold Star Program. The IG provides instructors with the base means from which to deliver training. Individual IGs are to be reviewed in conjunction with the Lesson Specifications (LSs) found in chapter 4 of A-CR-CCP-704/PG-001, Royal Canadian Army Cadet Gold Star Qualification Standard and Plan, before instructing, so that each instructor can adequately plan for and prepare each lesson. Instructors may be required to develop instructional materials to support training in addition to any that may be provided, eg, posters, videos, handouts, models, etc, supplemental to training control and support documents. Suggested instructional activities are included in most IGs to maximize learning and fun. Instructors are also encouraged to modify and / or enhance the activities, as long as they continue to contribute to enabling objective achievement.
4. **Use of the IG.** Throughout these instructional guides, a series of information boxes are used to highlight information; they include:



Note to the Instructor.



Key information to pass along to cadets.



Refer to the following CF regulations and policies.



Points of interest or special instructions the instructor should pass along to cadets.

5. **Suggested Changes.** Suggested changes to this document may be sent directly to cadettraining@canada.ca.

THIS PAGE INTENTIONALLY LEFT BLANK

TABLE OF CONTENTS

| | | PAGE |
|------------------|---|-------------|
| CHAPTER 1 | PO 400 – PARTICIPATE IN POSITIVE SOCIAL RELATIONS FOR YOUTH TRAINING | |
| | PO 400 – PARTICIPATE IN POSITIVE SOCIAL RELATIONS FOR YOUTH TRAINING..... | 400-1 |
| CHAPTER 2 | PO X01 – PARTICIPATE IN CITIZENSHIP ACTIVITIES | |
| | PO X01 – PARTICIPATE IN CITIZENSHIP ACTIVITIES | X01-1 |
| CHAPTER 3 | PO X02 – PERFORM COMMUNITY SERVICE | |
| | PO X02 – PERFORM COMMUNITY SERVICE | X02-1 |
| CHAPTER 4 | PO 403 – ACT AS A TEAM LEADER | |
| Section 1 | EO M403.01 – DESCRIBE NEEDS AND EXPECTATIONS OF TEAM MEMBERS..... | M403.01-1 |
| Attachment A | NEEDS AND EXPECTATIONS OF TEAM MEMBERS | M403.01A-1 |
| Section 2 | EO M403.02 – SELECT A LEADERSHIP APPROACH..... | M403.02-1 |
| Attachment A | | M403.02A-1 |
| Attachment B | | M403.02B-1 |
| Attachment C | SCENARIOS | M403.02C-1 |
| Attachment D | TRANSACTIONAL AND TRANSFORMATIONAL LEADERSHIP | M403.02D-1 |
| Section 3 | EO M403.03 – MOTIVATE TEAM MEMBERS..... | M403.03-1 |
| Attachment A | EXTRINSIC MOTIVATORS | M403.03A-1 |
| Attachment B | INTRINSIC MOTIVATORS | M403.03B-1 |
| Attachment C | | M403.03C-1 |
| Section 4 | EO M403.04 – PROVIDE FEEDBACK TO TEAM MEMBERS | M403.04-1 |
| Attachment A | SCENARIOS FOR PROVIDING FEEDBACK | M403.04A-1 |
| Attachment B | EFFECTIVE FEEDBACK | M403.04B-1 |
| Section 5 | EO M403.05 – PARTICIPATE IN A MENTORING RELATIONSHIP ... | M403.05-1 |
| Attachment A | SCENARIO FOR THE MENTORING DEMONSTRATION | M403.05A-1 |
| Attachment B | SCENARIO 1 FOR THE ROLE-PLAY ACTIVITY | M403.05B-1 |
| Attachment C | SCENARIO 2 FOR THE ROLE-PLAY ACTIVITY | M403.05C-1 |
| Section 6 | EO M403.06 – ACT AS A TEAM LEADER DURING A LEADERSHIP APPOINTMENT..... | M403.06-1 |
| Attachment A | | M403.06A-1 |
| Attachment B | | M403.06B-1 |
| Section 7 | EO C403.01 – PARTICIPATE IN A LEADERSHIP SEMINAR | C403.01-1 |
| Attachment A | SEMINAR INFORMATION | C403.01A-1 |
| Attachment B | LEADERSHIP SEMINAR PROBLEM SOLVING | C403.01B-1 |
| Appendix 1 | | C403.01B1-1 |
| Appendix 2 | NASA SURVIVAL ON THE MOON TEAM ANSWER SHEET | C403.01B2-1 |

TABLE OF CONTENTS (Cont)

| | PAGE |
|------------------|---|
| Appendix 3 | ANSWERS TO THE SURVIVAL ON THE MOON C403.01B3-1 |
| Appendix 4 | STEPLADDER OR SIX THINKING HATS SCENARIO C403.01B4-1 |
| Appendix 5 | PROBLEMS TO SOLVE C403.01B5-1 |
| Appendix 6 | ANSWER KEY TO PROBLEMS C403.01B6-1 |
| Attachment C | LEADERSHIP SEMINAR TIME MANAGEMENT C403.01C-1 |
| Appendix 1 | SCENARIO FOR CREATING A TO-DO LIST C403.01C1-1 |
| Attachment D | LEADERSHIP SEMINAR COMMUNICATIONS C403.01D-1 |
| Appendix 1 | C403.01D1-1 |
| Appendix 2 | SCENARIO FOR ROLE-PLAY C403.01D2-1 |
| Appendix 3 | READING BODY LANGUAGE C403.01D3-1 |
| Attachment E | LEADERSHIP SEMINAR SUPERVISION C403.01E-1 |
| Appendix 1 | C403.01E1-1 |
| Appendix 2 | SCENARIO FOR SUPERVISION PLAN C403.01E2-1 |
| Section 8 | EO C403.02 – CONDUCT AN EVENING ACTIVITY DURING A FIELD TRAINING EXERCISE (FTX)..... C403.02-1 |
| Attachment A | C403.02A-1 |
| CHAPTER 5 | PO X04 – TRACK PARTICIPATION IN PHYSICAL ACTIVITIES |
| | PO X04 – TRACK PARTICIPATION IN PHYSICAL ACTIVITIES..... X04-1 |
| CHAPTER 6 | PO X05 – PARTICIPATE IN PHYSICAL ACTIVITIES |
| | PO X05 – PARTICIPATE IN PHYSICAL ACTIVITIES X05-1 |
| CHAPTER 7 | PO 406 – FIRE THE CADET AIR RIFLE DURING RECREATIONAL MARKSMANSHIP |
| Section 1 | EO M406.01 – PARTICIPATE IN A RECREATIONAL MARKSMANSHIP ACTIVITY..... M406.01-1 |
| Attachment A | CLASSIFICATION ACTIVITY M406.01A-1 |
| Attachment B | M406.01B-1 |
| Attachment C | M406.01C-1 |
| Attachment D | M406.01D-1 |
| Attachment E | M406.01E-1 |
| Attachment F | M406.01F-1 |
| Attachment G | M406.01G-1 |
| Attachment H | M406.01H-1 |
| Attachment I | COMPETITIVE ACTIVITIES M406.01I-1 |
| Attachment J | M406.01J-1 |
| Section 2 | EO C406.01 – ASSIST THE RANGE SAFETY OFFICER (RSO)..... C406.01-1 |
| Attachment A | WAYS TO ASSIST THE RSO C406.01A-1 |
| Section 3 | EO C406.02 – SCORE AIR RIFLE MARKSMANSHIP TARGETS C406.02-1 |

TABLE OF CONTENTS (Cont)

| | | PAGE |
|------------------|---|-------------|
| Attachment A | SAMPLE GROUPING TARGET | C406.02A-1 |
| Attachment B | AIR RIFLE GROUPING TEMPLATE | C406.02B-1 |
| Attachment C | SAMPLE COMPETITION TARGET | C406.02C-1 |
| Attachment D | SCORING TEMPLATE | C406.02D-1 |
| | | |
| CHAPTER 8 | PO 407 – SERVE IN AN ARMY CADET CORPS | |
| Section 1 | EO M407.01 – IDENTIFY GOLD STAR TRAINING OPPORTUNITIES | M407.01-1 |
| Attachment A | | M407.01A-1 |
| Section 2 | EO M407.02 – IDENTIFY YEAR FOUR CADET SUMMER TRAINING CENTRE (CSTC) TRAINING OPPORTUNITIES..... | M407.02-1 |
| Section 3 | EO M407.03 – IDENTIFY THE STRUCTURE OF A CADET CORPS. | M407.03-1 |
| Attachment A | TERMS OF REFERENCE–REGIMENTAL SERGEANT MAJOR (RSM) | M407.03A-1 |
| Attachment B | TERMS OF REFERENCE–COMPANY SERGEANT MAJOR (CSM) . | M407.03B-1 |
| Attachment C | TERMS OF REFERENCE–PLATOON WARRANT OFFICER (PL WO) | M407.03C-1 |
| Attachment D | TERMS OF REFERENCE–DRUM MAJOR (DM) | M407.03D-1 |
| Attachment E | TERMS OF REFERENCE–FLAG PARTY COMMANDER (FLAG PARTY COMD) | M407.03E-1 |
| Attachment F | TERMS OF REFERENCE–TRAINING ASSISTANT | M407.03F-1 |
| Attachment G | TERMS OF REFERENCE–SUPPLY ASSISTANT | M407.03G-1 |
| Attachment H | TERMS OF REFERENCE–ADMINISTRATION ASSISTANT | M407.03H-1 |
| Attachment I | FUNCTIONAL ORGANIZATIONAL CHART | M407.03I-1 |
| Attachment J | TERMS OF REFERENCE–STAR LEVEL NCO | M407.03J-1 |
| Attachment K | TERMS OF REFERENCE–DRILL AND CEREMONIAL INSTRUCTOR | M407.03K-1 |
| Attachment L | TERMS OF REFERENCE–EXPEDITION INSTRUCTOR | M407.03L-1 |
| Attachment M | TERMS OF REFERENCE–FITNESS AND SPORTS INSTRUCTOR . | M407.03M-1 |
| Attachment N | TERMS OF REFERENCE–MUSIC INSTRUCTOR | M407.03N-1 |
| Attachment O | TERMS OF REFERENCE–AIR RIFLE MARKSMANSHIP INSTRUCTOR | M407.03O-1 |
| Attachment P | TRAINING ORGANIZATIONAL CHART | M407.03P-1 |
| Attachment Q | TERMS OF REFERENCE–DUTY NCO | M407.03Q-1 |
| Attachment R | TERMS OF REFERENCE–DUTY ASSISTANTS | M407.03R-1 |
| Attachment S | DUTY ORGANIZATIONAL CHART | M407.03S-1 |
| Attachment T | ACTIVITY SCENARIO | M407.03T-1 |
| Attachment U | ACTIVITY SCENARIO ANSWER SHEET | M407.03U-1 |
| Section 4 | EO C407.01 – PREPARE FOR A MERIT REVIEW BOARD..... | C407.01-1 |
| Attachment A | EXAMPLE QUESTIONS TO EXPECT AT A MERIT REVIEW BOARD FOR PROMOTION | C407.01A-1 |

TABLE OF CONTENTS (Cont)

| | PAGE |
|--|-------------|
| Attachment B PREPARATION FOR A MERIT REVIEW BOARD FOR PROMOTION | C407.01B-1 |
| Attachment C | C407.01C-1 |
| Attachment D DRESS INSPECTION SCORESHEET | C407.01D-1 |
| CHAPTER 9 PO 408 – COMMAND A PLATOON ON PARADE | |
| Section 1 EO M408.01 – DISCUSS COMMANDING A PLATOON ON PARADE..... | M408.01-1 |
| Section 2 EO M408.02 – IDENTIFY PARADE SEQUENCE..... | M408.02-1 |
| Section 3 EO M408.03 – COMMAND A SQUAD..... | M408.03-1 |
| Attachment A | M408.03A-1 |
| Section 4 EO M408.04 – INSPECT A CADET ON PARADE..... | M408.04-1 |
| Attachment A DRESS INSTRUCTIONS ACTIVITY WORKSHEET | M408.04A-1 |
| Attachment B DRESS INSTRUCTIONS ACTIVITY WORKSHEET ANSWER SHEET | M408.04B-1 |
| Attachment C DRESS INSTRUCTIONS CHECKLIST | M408.04C-1 |
| Section 5 EO C408.01 – DISCUSS THE HISTORY OF DRILL..... | C408.01-1 |
| Attachment A SUMMARY OF SIGNIFICANT DRILL EVENTS | C408.01A-1 |
| Section 6 EO C408.02 – VIEW A RE-ENACTMENT THAT DEMONSTRATES THE HISTORY OF DRILL..... | C408.02-1 |
| CHAPTER 10 PO 409 – INSTRUCT A LESSON | |
| Section 1 EO M409.01 – IDENTIFY METHODS OF INSTRUCTION..... | M409.01-1 |
| Attachment A | M409.01A-1 |
| Attachment B | M409.01B-1 |
| Attachment C | M409.01C-1 |
| Attachment D | M409.01D-1 |
| Attachment E | M409.01E-1 |
| Attachment F | M409.01F-1 |
| Attachment G METHOD MADNESS | M409.01G-1 |
| Attachment H METHODS OF INSTRUCTION SUMMARY | M409.01H-1 |
| Section 2 EO M409.02 – IDENTIFY ELEMENTS OF A POSITIVE LEARNING ENVIRONMENT..... | M409.02-1 |
| Attachment A RELAXATION EXERCISES | M409.02A-1 |
| Attachment B CREATE A POSITIVE LEARNING ENVIRONMENT CROSSWORD PUZZLE | M409.02B-1 |
| Attachment C CREATE A POSITIVE LEARNING ENVIRONMENT ANSWER KEY . | M409.02C-1 |
| Section 3 EO M409.03 – DESCRIBE LEARNER NEEDS..... | M409.03-1 |
| Attachment A | M409.03A-1 |
| Attachment B LEARNING PYRAMID | M409.03B-1 |
| Attachment C DEVELOPMENTAL PERIODS CONFIRMATION | M409.03C-1 |

TABLE OF CONTENTS (Cont)

| | | PAGE |
|--------------|--|-------------|
| Attachment D | LEARNING STYLES INFORMATION SHEET | M409.03D-1 |
| Attachment E | LEARNING STYLES SURVEY | M409.03E-1 |
| Attachment F | HOW TO MAKE A JUMPING FROG | M409.03F-1 |
| Attachment G | HOW TO MAKE A TRIANGULAR BOX | M409.03G-1 |
| Attachment H | | M409.03H-1 |
| Attachment I | INSTRUCTOR TIPS FOR LEARNING STYLES | M409.03I-1 |
| Attachment J | INSTRUCTOR TIPS FOR LEARNING STYLES ANSWER KEY | M409.03J-1 |
| Attachment K | ACTIVITIES IN DEVELOPMENTAL PERIODS | M409.03K-1 |
| Attachment L | ACTIVITIES IN DEVELOPMENTAL PERIODS ANSWER KEY | M409.03L-1 |
| Section 4 | EO M409.04 – EXPLAIN ASSESSMENT | M409.04-1 |
| Attachment A | ASSESSMENT OF LEARNING PLAN – SILVER STAR | M409.04A-1 |
| Attachment B | 303 PC ASSESSMENT INSTRUCTIONS..... | M409.04B-1 |
| Attachment C | 303 PC ASSESSMENT RUBRIC | M409.04C-1 |
| Attachment D | 308 PC ASSESSMENT CHECKLIST | M409.04D-1 |
| Attachment E | 322 PC ASSESSMENT CHECKLIST | M409.04E-1 |
| Section 5 | EO M409.05 – INSTRUCT A 30-MINUTE LESSON..... | M409.05-1 |
| Section 6 | EO C409.01 – PLAN A LESSON..... | C409.01-1 |
| Section 7 | EO C409.02 – INSTRUCT A 30-MINUTE LESSON..... | C409.02-1 |
| Section 8 | EO C409.03 – ACT AS AN ASSISTANT INSTRUCTOR..... | C409.03-1 |
| Section 9 | EO C409.04 – PARTICIPATE IN A CREATIVE LESSON-PLANNING WORKSHOP..... | C409.04-1 |
| Attachment A | MIXER | C409.04A-1 |
| Attachment B | PIGTURE THIS... | C409.04B-1 |
| Attachment C | CLICHE STRECTCHING | C409.04C-1 |
| Attachment D | MIXER ANSWER KEY | C409.04D-1 |
| Attachment E | | C409.04E-1 |
| Attachment F | THE BENEFITS OF CREATIVE LESSONS | C409.04F-1 |
| Attachment G | | C409.04G-1 |
| Attachment H | | C409.04H-1 |
| Attachment I | BENEFITS OF CREATIVE LESSONS PHRASE STRIPS | C409.04I-1 |
| Attachment J | THE CREATIVE PROCESS | C409.04J-1 |
| Attachment K | | C409.04K-1 |
| Attachment L | | C409.04L-1 |
| Attachment M | WAYS TO INCORPORATE CREATIVITY | C409.04M-1 |
| Section 10 | EO C409.05 – ACT AS AN ASSISTANT DRILL INSTRUCTOR..... | C409.05-1 |
| Section 11 | EO C409.06 – INSTRUCT A 30-MINUTE DRILL LESSON..... | C409.06-1 |
| Attachment A | DRILL INSTRUCTIONAL TECHNIQUE ASSESSMENT FORM | C409.06A-1 |

TABLE OF CONTENTS (Cont)

| | | PAGE |
|-------------------|---|------------|
| CHAPTER 11 | PO X20 – PARTICIPATE IN CAF FAMILIARIZATION | |
| | PO X20 – PARTICIPATE IN CAF FAMILIARIZATION..... | X20-1 |
| CHAPTER 12 | PO 422 – FOLLOW A MULTI-LEG ROUTE USING A GLOBAL POSITIONING SYSTEM (GPS) RECEIVER | |
| Section 1 | EO M422.01 – REVIEW SILVER STAR NAVIGATION..... | M422.01-1 |
| Attachment A | SILVER STAR NAVIGATION REVIEW WORKSHEET | M422.01A-1 |
| Attachment B | SILVER STAR NAVIGATION REVIEW WORKSHEET ANSWER KEY | M422.01B-1 |
| Attachment C | LEARNING STATION 1 INFORMATION SHEET | M422.01C-1 |
| Attachment D | LEARNING STATION 2 INFORMATION SHEET | M422.01D-1 |
| Attachment E | LEARNING STATION 3 INFORMATION SHEET | M422.01E-1 |
| Section 2 | EO M422.02 – SET A MULTI-LEG ROUTE USING A GLOBAL POSITIONING SYSTEM (GPS) RECEIVER..... | M422.02-1 |
| Section 3 | EO M422.03 – FOLLOW A MULTI-LEG ROUTE USING A GLOBAL POSITIONING SYSTEM (GPS) RECEIVER..... | M422.03-1 |
| Attachment A | INPUT A MULTI-LEG ROUTE IN THE MAGELLAN EXPLORIST 200 GPS RECEIVER | M422.03A-1 |
| Section 4 | EO C422.01 – LOCATE A GEOCACHE..... | C422.01-1 |
| Attachment A | GEOCACHE INFORMATION FORM | C422.01A-1 |
| Section 5 | EO C422.02 – CREATE A GEOCACHE..... | C422.02-1 |
| Attachment A | STASH A CACHE RECORD AND REPORT FORM..... | C422.02A-1 |
| Section 6 | EO C422.03 – DISCUSS MAP SOFTWARE..... | C422.03-1 |
| Section 7 | EO C422.04 – MEASURE A GRID BEARING WITH A PROTRACTOR..... | C422.04-1 |
| Attachment A | STEPS TO MEASURE A GRID BEARING WITH A PROTRACTOR .. | C422.04A-1 |
| Attachment B | STEPS TO CONVERTING BEARINGS | C422.04B-1 |
| Section 8 | EO C422.05 – DETERMINE LOCATION USING RESECTION..... | C422.05-1 |
| Attachment A | STEPS TO DETERMINE LOCATION USING RESECTION | C422.05A-1 |
| Section 9 | EO C422.06 – PRACTICE NAVIGATION AS A MEMBER OF A SMALL GROUP..... | C422.06-1 |
| CHAPTER 13 | PO 424 – EMPLOY NATURAL RESOURCES IN A SURVIVAL SITUATION | |
| Section 1 | EO M424.01 – SHARPEN A SURVIVAL KNIFE..... | M424.01-1 |
| Section 2 | EO M424.02 – EMPLOY THE IMPROVISING PROCESS..... | M424.02-1 |
| Attachment A | RIVER FOLLY | M424.02A-1 |
| Section 3 | EO M424.03 – WEAVE CORDAGE..... | M424.03-1 |
| Section 4 | EO C424.01 – WHITTLE WOOD..... | C424.01-1 |
| Attachment A | WHITTLE A WHISTLE | C424.01A-1 |
| Section 5 | EO C424.02 – BOIL WATER USING HEATED ROCKS..... | C424.02-1 |

TABLE OF CONTENTS (Cont)

| | | PAGE |
|-------------------|--|-------------|
| Section 6 | EO C424.03 – EMPLOY CATTAILS..... | C424.03-1 |
| Section 7 | EO C424.04 – PREPARE REMEDIES FOR COMMON AILMENTS USING MEDICINAL PLANTS..... | C424.04-1 |
| | | |
| CHAPTER 14 | PO 425 – DEVELOP AN EXPEDITION PLAN | |
| Section 1 | EO M425.01 – ESTABLISH EXPEDITION PARAMETERS..... | M425.01-1 |
| Attachment A | | M425.01A-1 |
| Attachment B | EXPEDITION PARAMETERS INFORMATION SHEET | M425.01B-1 |
| Attachment C | SILVER STAR EXPEDITION INFORMATION SHEET | M425.01C-1 |
| Attachment D | COMPLETED SECTION 1 OF THE EXPEDITION PLANNING BOOKLET | M425.01D-1 |
| Section 2 | EO M425.02 – PLAN AN EXPEDITION ROUTE..... | M425.02-1 |
| Attachment A | | M425.02A-1 |
| Attachment B | | M425.02B-1 |
| Attachment C | | M425.02C-1 |
| Attachment D | CAMPGROUND INFORMATION | M425.02D-1 |
| Attachment E | MOUNTAIN BIKE TRAILS INFORMATION | M425.02E-1 |
| Attachment F | CANOE ROUTE INFORMATION | M425.02F-1 |
| Attachment G | HOSPITAL INFORMATION | M425.02G-1 |
| Attachment H | | M425.02H-1 |
| Section 3 | EO M425.03 – DEVELOP AN EXPEDITION EQUIPMENT LIST..... | M425.03-1 |
| Attachment A | | M425.03A-1 |
| Attachment B | | M425.03B-1 |
| Section 4 | EO M425.04 – DEVELOP AN EXPEDITION RATION PLAN..... | M425.04-1 |
| Attachment A | | M425.04A-1 |
| Attachment B | ENERGY EXPENDITURES FOR PHYSICAL ACTIVITY INFORMATION SHEET | M425.04B-1 |
| Attachment C | EXPEDITION RATION PLAN INFORMATION SHEET | M425.04C-1 |
| Attachment D | | M425.04D-1 |
| Attachment E | | M425.04E-1 |
| Section 5 | EO C425.01 – DISCUSS ACTIONS TAKEN WHEN A PERSON IS LOST..... | C425.01-1 |
| Section 6 | EO C425.02 – ANALYZE PROBLEMS USING AN EXPEDITION CASE STUDY..... | C425.02-1 |
| Attachment A | CASE STUDY WORKSHEET | C425.02A-1 |
| Attachment B | | C425.02B-1 |
| | | |
| CHAPTER 15 | PO 426 – PERFORM EXPEDITION SKILLS | |
| Section 1 | EO M426.01 – PREPARE FOR EXPEDITION TRAINING..... | M426.01-1 |
| Attachment A | NAVIGATION REVIEW PACKAGE | M426.01A-1 |

TABLE OF CONTENTS (Cont)

| | | PAGE |
|--------------|--|-------------|
| Attachment B | NAVIGATION REVIEW PACKAGE ANSWERS | M426.01B-1 |
| Section 2 | EO M426.02A – PADDLE A CANOE..... | M426.02a-1 |
| Section 3 | EO M426.02B – RIDE A MOUNTAIN BIKE..... | M426.02b-1 |
| Section 4 | EO M426.02C – HIKE ALONG A ROUTE..... | M426.02c-1 |
| Section 5 | EO M426.02D – SNOWSHOE ALONG A ROUTE..... | M426.02d-1 |
| Section 6 | EO M426.02E – SKI ALONG A ROUTE..... | M426.02e-1 |
| Attachment A | CROSS-COUNTRY SKI EQUIPMENT SIZING INFORMATION FORM | M426.02eA-1 |



**COMMON TRAINING
MASTER CADET
INSTRUCTIONAL GUIDE**



POSITIVE SOCIAL RELATIONS FOR YOUTH

SECTION 1

PO 400 – PARTICIPATE IN POSITIVE SOCIAL RELATIONS FOR YOUTH TRAINING

Total Time:

The instructional guides for this PO are located in A-CR-CCP-915/PG-001, *Positive Social Relations for Youth Training Facilitator's Package*.

THIS PAGE INTENTIONALLY LEFT BLANK



**COMMON TRAINING
ALL TRAINING LEVELS
INSTRUCTIONAL GUIDE
CITIZENSHIP**



SECTION 1

PO X01 – PARTICIPATE IN CITIZENSHIP ACTIVITIES

Total Time:

For the following EOs, refer to the lesson specifications located in A-CR-CCP-701/PG-001, *Royal Canadian Army Cadets Green Star Qualification Standard and Plan*:

- MX01.01A – Participate in a Citizenship Tour,
- MX01.01B – Attend a Presentation by a Community Organization,
- MX01.01C – Attend a Presentation by a Citizen-of-Interest,
- MX01.01D – Participate in the Canadian Citizenship Challenge,
- MX01.01E – Host a Citizenship Ceremony, and
- CX01.01 – Participate in Citizenship Activities.

For the following EOs, refer to the instructional guides located in A-CR-CCP-701/PF-001, *Royal Canadian Army Cadets Green Star Instructional Guides*:

- MX01.01F – Participate in an Election,
- MX01.01G – Participate in Heritage Minutes Video Activities, and
- MX01.01H – Participate in Citizenship Learning Stations.

THIS PAGE INTENTIONALLY LEFT BLANK



**COMMON TRAINING
ALL TRAINING LEVELS
INSTRUCTIONAL GUIDE
COMMUNITY SERVICE**



SECTION 1

PO X02 – PERFORM COMMUNITY SERVICE

Total Time:

For the following EOs, refer to the instructional guides located in A-CR-CCP-701/PF-001, *Royal Canadian Army Cadets Green Star Instructional Guides*:

- MX02.01 – Perform Community Service, and
- CX02.01 – Perform Community Service.

THIS PAGE INTENTIONALLY LEFT BLANK



**COMMON TRAINING
GOLD STAR
INSTRUCTIONAL GUIDE**



SECTION 1

EO M403.01 – DESCRIBE NEEDS AND EXPECTATIONS OF TEAM MEMBERS

Total Time:

30 min

PREPARATION

PRE-LESSON INSTRUCTIONS

Resources needed for the delivery of this lesson are listed in the lesson specification located in A-CR-CCP-704/PG-001, *Gold Star Qualification Standard and Plan*, Chapter 4. Specific uses for said resources are identified throughout the instructional guide within the TP for which they are required.

Review the lesson content and become familiar with the material prior to delivering the lesson.

Photocopy the Needs and Expectations of Team Members handout located at Attachment A for each cadet.

PRE-LESSON ASSIGNMENT

Nil.

APPROACH

An interactive lecture was chosen for TP 1 to orient the cadets to team members' needs.

An in-class activity was chosen for TP 2 as it is an interactive way to provoke thought and stimulate interest among cadets about expectations that a team member has of a team leader.

A group discussion was chosen for TP 3 as it allows the cadets to interact with their peers and share their knowledge, experiences, opinions and feelings about how a team leader should strive to meet team members needs and expectations.

INTRODUCTION

REVIEW

Nil.

OBJECTIVES

By the end of this lesson the cadet shall be expected to describe the needs and expectations of team members.

IMPORTANCE

It is important for cadets to describe the needs and expectations of team members to assist in the development of their leadership skills. This information aids the cadets in meeting the aim of developing in youth the attributes of good leadership stated in CATO 11-03, *Cadet Program Mandate*. To become an effective team leader, the cadet must be aware of needs and expectations, and strive to satisfy those needs and expectations.

Teaching Point 1**Describe the needs of team members.**

Time: 5 min

Method: Interactive Lecture

THE NEEDS OF TEAM MEMBERS

To be an effective leader, a team leader must be aware that every team member has needs to be satisfied.

Acceptance of and by Other Team Members

Each team member needs to accept the other members of the team. There may be differences in age, gender, race and opinion but each team member should appreciate all other members. In turn, each team member needs to feel accepted by other team members. Once team members feel acknowledged and understood by others on the team, team members may strive to make teamwork possible. Once the team forms into a cohesive group, the accomplishment of a task becomes easier.

Acceptance and Understanding of Leaders

Team members need to know that the team leader will welcome them into the team. It is important for a team leader to encourage a sense of belonging in each team member. Team members also need the team leader to show compassion and sensitivity to their opinions and feelings.

Approval of Leaders

Team members need to know that the team leader appreciates them and their contribution. It is important for team leaders to show respect and praise team members.

Opportunities to Try Different Tasks and Roles

Team members need opportunities to attempt different tasks and roles to practice applying skills and knowledge.

CONFIRMATION OF TEACHING POINT 1**QUESTIONS:**

- Q1. What are the needs of team members?
- Q2. Once team members feel acknowledged and understood by others on the team, what may happen?
- Q3. How do team leaders show approval of team members?

ANTICIPATED ANSWERS:

- A1. The needs of team members are:
 - acceptance of and by other team members;
 - acceptance and understanding of leaders;
 - approval of leaders; and
 - opportunities to try different tasks and roles.
- A2. Once team members feel acknowledged and understood by others on the team, team members strive to make teamwork possible.
- A3. Team leaders show approval of team members by giving team members respect and praise.

Teaching Point 2**Conduct an activity where cadets describe the expectations that a team member has of a team leader.**

Time: 10 min

Method: In-Class Activity

BACKGROUND KNOWLEDGE



The purpose of the in-class activity is to draw the following information from the three groups.

THE EXPECTATIONS THAT A TEAM MEMBER HAS OF A TEAM LEADER

Every team member has expectations of the team leader. Team members hope that the team leader will fulfill their expectations. Team member expectations include:

Good Leadership

Team members expect good leadership from team leaders. Team leaders need to display good leadership, to include:

- **Leading by example.** Team members expect that what they are asked to do can also be done by the team leader. They expect the team leader will model the correct behaviour.
- **Putting the needs of the team members first.** The team leader is expected to put the team's needs ahead of their own. Team members need to know that the team leader will accept, approve and understand them. Team members also expect that the team leader will give them opportunities to try different tasks and roles.
- **Being sensitive to cultural and gender differences.** Each team member is unique and the team leader must have an awareness of the differences between each of them. Having an understanding of cultural and gender differences between members of the team will allow the team members to feel included and appreciated.

Effective Communication

Team members expect that the team leader will provide them with effective communication. Team leaders need to display effective communication to team members, to include:

- **Giving information on what is expected of them.** Team members need to know what is expected of them. Team members require basic information about what they are to accomplish.
- **Explaining changes in situations.** Team members like to know when changes in situations occur. Keeping team members informed of changes and providing new directions may ensure that goals and tasks are accomplished.
- **Asking for assistance with tasks.** Team members are more cooperative when they are asked for assistance by the team leader rather than being ordered to do something. By asking for the team's assistance, team members may feel needed by their team leader.
- **Providing concrete examples during explanations.** Team members may understand concepts and ideas more easily if the team leader uses examples from life and if the team leader can connect the concept or idea to what the team member already knows.

Effective Supervision

Team members expect that the team leader will provide them with effective supervision. Team leaders need to effectively supervise team members, to include:

- **Operating in a safe environment.** Team members expect to be operating in a safe environment. Every team leader must be concerned with the team's safety and well-being at all times.
- **Freedom from over-supervision.** Team members should feel like their team leader has confidence in them to accomplish tasks. Very few team members appreciate it when the team leader is always looking over their shoulder.
- **Recognition of good performance.** Team members like to be praised when things go well. Praise may be verbal or may take the form of certificates and awards.

ACTIVITY

Time: 10 min

OBJECTIVE

The objective of this activity is to have the cadets describe the expectations that a team member has of a team leader.

RESOURCES

- Three flip charts, and
- Three markers.

ACTIVITY LAYOUT

Set a flip chart in three corners of the room.

ACTIVITY INSTRUCTIONS

1. Divide the cadets into three groups.
2. Assign each group to a flip chart.
3. Have each group write one of the headings on the flip chart: Good Leadership, Effective Communication, and Effective Supervision.
4. Have the cadets brainstorm short descriptions for the heading on the flip chart paper for three minutes and write their ideas on the flip chart paper.
5. Have one cadet from each group present their ideas to the rest of the cadets.



Any of the background information that was missed during the presentation by cadets must be stated before moving to the next TP.

SAFETY

Nil.

CONFIRMATION OF TEACHING POINT 2

The cadets' participation in the activity will serve as the confirmation for this TP.

Teaching Point 3

Conduct a group discussion on how a team leader should strive to meet the needs and expectations of team members.

Time: 10 min

Method: Group Discussion



If the class of Gold Star cadets is large, divide them into groups.

This teaching point has been designed to provide the cadets an opportunity to reflect on and share their opinions and feelings about how a team leader should strive to meet team members' needs and expectations.

BACKGROUND KNOWLEDGE



The purpose of the group discussion is to draw information from the group using the tips for answering / facilitating discussion and the suggested questions provided.

GROUP DISCUSSION



TIPS FOR ANSWERING / FACILITATING DISCUSSION:

- Establish ground rules for discussion, eg, everyone should listen respectfully; don't interrupt; only one person speaks at a time; no one's ideas should be made fun of; you can disagree with ideas but not with the person; try to understand others as much as you hope they understand you; etc.
- Sit the group in a circle, making sure all cadets can be seen by everyone else.
- Ask questions that will provoke thought; in other words avoid questions with yes or no answers.
- Manage time by ensuring the cadets stay on topic.
- Listen and respond in a way that indicates you have heard and understood the cadet. This can be done by paraphrasing their ideas.
- Give the cadets time to respond to your questions.
- Ensure every cadet has an opportunity to participate. One option is to go around the group and have each cadet answer the question with a short answer. Cadets must also have the option to pass if they wish.
- Additional questions should be prepared ahead of time.

SUGGESTED QUESTIONS:

- Q1. Give examples of when you have seen a team leader satisfy the needs of their team members.
- Q2. List ways a team leader might satisfy the needs of their team members.
- Q3. Give examples of when you have seen a team leader meet the expectations of team members.
- Q4. List ways a team leader might meet the expectations of their team.
- Q5. Give examples of when you have seen a team leader not satisfy the needs or not meet the expectations of their team.



Other questions and answers will develop throughout the group discussion. The group discussion should not be limited to only those suggested.



Reinforce those answers given and comments made during the group discussion, ensuring the teaching point has been covered.

CONFIRMATION OF TEACHING POINT 3

The cadets' participation in the group discussion will serve as the confirmation of this TP.

END OF LESSON CONFIRMATION**QUESTIONS:**

- Q1. What are the needs of team members?
- Q2. What are the three expectations that team members have of the team leader?
- Q3. List ways a team leader might satisfy the needs or meet the expectations of their team members.

ANTICIPATED ANSWERS:

- A1. The needs of team members are:
 - acceptance of and by other team members;
 - acceptance and understanding of leaders;
 - approval of leaders; and
 - opportunities to try different tasks and roles.

A2. The three expectations that team members have of the team leader are:

- good leadership,
- effective communication, and
- effective supervision.

A3. Answers will vary.



Distribute the Needs and Expectations of Team Members handout located at Attachment A to each cadet.

CONCLUSION

HOMEWORK / READING / PRACTICE

Nil.

METHOD OF EVALUATION

This EO is assessed IAW A-CR-CCP-704/PG-001, *Gold Star Qualification Standard and Plan*, Chapter 3, Annex B, 403 PC.

CLOSING STATEMENT

To be an effective leader, team leaders must satisfy the needs and meet the expectations of team members. Having an awareness of those needs and expectations will assist the team leader in doing so.

INSTRUCTOR NOTES / REMARKS

Nil.

REFERENCES

A0-047 A-PA-005-000/AP-004 Canadian Defence Academy–Canadian Forces Leadership Institute. (2005). *Leadership in the CF conceptual foundations*. Ottawa, ON: Department of National Defence.

A0-048 A-PA-005-000/AP-003 Canadian Defence Academy–Canadian Forces Leadership Institute. (2005). *Leadership in the CF doctrine foundations*. Ottawa, ON: Department of National Defence.

A0-131 A-CR-CCP-910/PT-001 Director Cadets 6. (1989). *Training school leadership*. Ottawa, ON: Department of National Defence.

C0-115 ISBN 0-7879-4059-3 van Linden, J. A., & Fertman, C. I. (1998). *Youth leadership*. San Francisco, CA: Jossey-Bass Inc., Publishers.

NEEDS AND EXPECTATIONS OF TEAM MEMBERS

THE NEEDS OF TEAM MEMBERS

To be an effective leader, a team leader must be aware that every team member has needs to be satisfied.

Acceptance of and by Other Team Members

Each team member needs to accept the other members of the team. There may be differences in age, gender, race and opinion but each team member should appreciate all other members. In turn, each team member needs to feel accepted by other team members. Once team members feel acknowledged and understood by others on the team, team members may strive to make teamwork possible. Once the team forms into a cohesive group, the accomplishment of a task becomes easier.

Acceptance and Understanding of Leaders

Team members need to know that the team leader will welcome them into the team. It is important for a team leader to encourage a sense of belonging in each team member. Team members also need the team leader to show compassion and sensitivity to their opinions and feelings.

Approval of Leaders

Team members need to know that the team leader appreciates them and their contribution. It is important for team leaders to show respect and praise team members.

Opportunities to Try Different Tasks and Roles

Team members need opportunities to attempt different tasks and roles to practice applying skills and knowledge.

THE EXPECTATIONS THAT A TEAM MEMBER HAS OF A TEAM LEADER

Every team member has expectations of the team leader. Team members hope that the team leader will fulfill their expectations. Team member expectations include:

Good Leadership

Team members expect good leadership from team leaders. Team leaders need to display good leadership, to include:

- **Leading by example.** Team members expect that what they are asked to do can also be done by the team leader. They expect the team leader will model the correct behaviour.
- **Putting the needs of the team members first.** The team leader is expected to put the team's needs ahead of their own. Team members need to know that the team leader will accept, approve and understand them. Team members also expect that the team leader will give them opportunities to try different tasks and roles.
- **Being sensitive to cultural and gender differences.** Each team member is unique and the team leader must have an awareness of the differences between each of them. Having an understanding of cultural and gender differences between members of the team will allow the team members to feel included and appreciated.

Effective Communication

Team members expect that the team leader will provide them with effective communication. Team leaders need to display effective communication to team members, to include:

- **Giving information on what is expected of them.** Team members need to know what is expected of them. Team members require basic information about what they are to accomplish.
- **Explaining changes in situations.** Team members like to know when changes in situations occur. Keeping team members informed of changes and providing new directions may ensure that goals and tasks are accomplished.
- **Asking for assistance with tasks.** Team members are more cooperative when they are asked for assistance by the team leader rather than being ordered to do something. By asking for the team's assistance, team members may feel needed by their team leader.
- **Providing concrete examples during explanations.** Team members may understand concepts and ideas more easily if the team leader uses examples from life and if the team leader can connect the concept or idea to what the team member already knows.

Effective Supervision

Team members expect that the team leader will provide them with effective supervision. Team leaders need to effectively supervise team members, to include:

- **Operating in a safe environment.** Team members expect to be operating in a safe environment. Every team leader must be concerned with the team's safety and well-being at all times.
- **Freedom from over-supervision.** Team members should feel like their team leader has confidence in them to accomplish tasks. Very few team members appreciate it when the team leader is always looking over their shoulder.
- **Recognition of good performance.** Team members like to be praised when things go well. Praise may be verbal or may take the form of certificates and awards.



**COMMON TRAINING
GOLD STAR
INSTRUCTIONAL GUIDE**



SECTION 2

EO M403.02 – SELECT A LEADERSHIP APPROACH

Total Time:

60 min

PREPARATION

PRE-LESSON INSTRUCTIONS

Resources needed for the delivery of this lesson are listed in the lesson specification located in A-CR-CCP-704/PG-001, *Gold Star Qualification Standard and Plan*, Chapter 4. Specific uses for said resources are identified throughout the instructional guide within the TP for which they are required.

Review the lesson content and become familiar with the material prior to delivering the lesson.

Photocopy the handouts located at Attachments A, B and D for each cadet.

Photocopy the scenarios located at Attachment C. Cut out a scenario for each cadet.

PRE-LESSON ASSIGNMENT

Nil.

APPROACH

An interactive lecture was chosen for TPs 1, 2 and 3 to review, clarify, emphasize and summarize transactional and transformational leadership, the outcomes of a team leader's focus and leadership approaches.

An in-class activity was chosen for TP 4 as it is an interactive way to provoke thought and stimulate interest among cadets.

INTRODUCTION

REVIEW

Nil.

OBJECTIVES

By the end of this lesson the cadet shall have selected a leadership approach.

IMPORTANCE

It is important for cadets to select a leadership approach in order to help them become effective team leaders during a leadership appointment. For every leadership opportunity, an effective leader will use a leadership approach that enables the team members to accomplish the goal.

Teaching Point 1**Describe transactional and transformational leadership.**

Time: 5 min

Method: Interactive Lecture

TRANSACTIONAL AND TRANSFORMATIONAL LEADERSHIP

Transactional leadership. Leaders exchange promises of rewards and benefits to team members so the team members will fulfill agreements with the leaders. This type of leadership is task-oriented. The leader sets the rules and procedures to complete a task and the team members comply with the rules and follow the procedures to accomplish the task.

Transactional Leadership:

- Values problem and solution identification.
- Makes decisions – even if everyone has not been heard – in order to move forward.
- Uses standards and principles as guides in decision making.
- Develops the self to be a better decision maker for the group.
- Gets things done.
- Recognizes the importance of the product.
- Takes charge (personal power).

Transformational leadership. Focuses on the process of being a leader by helping team members transform themselves from followers into leaders. Transformational leadership involves assisting team members to transcend their own self-interest for the good of the group, organization or society; to consider their long-term needs to develop themselves, rather than their immediate needs; and generally, to become more aware of what is really important.

Transformational Leadership:

- Values the participation and contribution of others.
- Takes all viewpoints and advice into account before making a decision.
- Considers individuals within their contexts and situations.
- Uses individuals to test decisions.
- Develops the self first to be a better contributor to the group.
- Learns from experiences to generalize to 'real life'.
- Recognizes the importance of the process.
- Shares leadership (group power).



Leadership within the cadet program has been designed to create transformational leadership. Transformational leadership enables the Cadet Program (CP) to meet its aim of developing in youth the attributes of good citizenship and leadership.

Transactional leadership focuses on the skills and tasks associated with leadership, such as public speaking, writing, delegating authority, leading meetings and making decisions. It is what people who are leaders do. Transformational leadership focuses on the process of leadership and what it means to be a leader. It is concerned with how individuals use their abilities to influence people. Think of the main difference between transactional and transformational leadership as doing leadership tasks versus being a leader.

CONFIRMATION OF TEACHING POINT 1

QUESTIONS:

- Q1. Describe transactional leadership.
- Q2. On what does transformational leadership focus?
- Q3. Leadership within the cadet program has been designed to create which kind of leadership?

ANTICIPATED ANSWERS:

- A1. Transactional leadership is when leaders exchange promises of rewards and benefits to team members so the team members will fulfill agreements with the leaders.
 - A2. Transformational leadership focuses on the process of being a leader by helping team members transform themselves from followers into leader.
 - A3. Leadership within the cadet program has been designed to create transformational leadership.
-

Teaching Point 2

Describe the outcomes that occur as a result of the team leader focussing on team members and the goal.

Time: 10 min

Method: Interactive Lecture



Distribute Attachment A to each cadet.

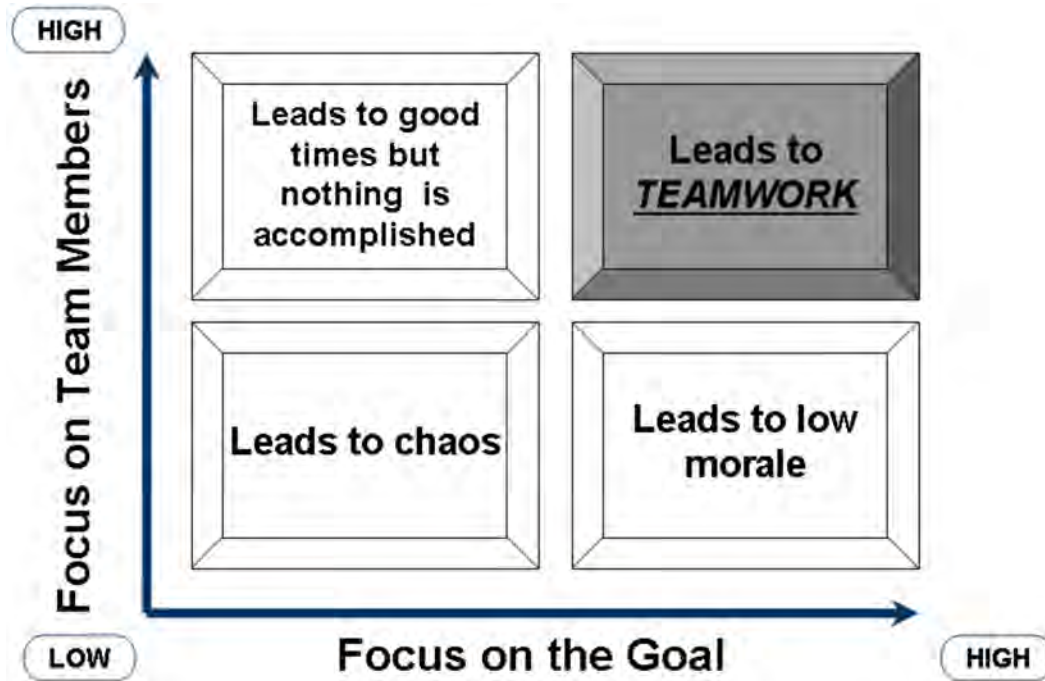



Figure 1 Outcomes as a Result of the Team Leader's Focus

Note. Created by Director Cadets 3, 2009, Ottawa, ON: Department of National Defence.

There are two main things on which to focus while leading a team: the team members and the goal.

If a team leader is not focused on the goal and is not focused on their team members, the outcome is usually chaos.



Ask cadets why they think chaos would occur. Ask cadets to provide one or two examples, from a leadership perspective, when they have seen such chaos occur. The examples do not necessarily need to involve the CP.

If a team leader is not concerned with the goal but is highly concerned about how their team members feel, the outcome may lead to good times but nothing gets accomplished.



Ask cadets why they think the result of good times but nothing gets accomplished may occur. Ask cadets to provide one or two examples, from a leadership perspective, when they have seen good times occur but nothing gets accomplished. The examples do not necessarily need to involve the CP.

If a team leader is highly concerned with the goal but not concerned about how their team member's feel, the outcome may lead to low morale.



Ask cadets why they think low morale would occur. Ask cadets to provide one or two examples, from a leadership perspective, of when they have seen low morale occur. The examples do not necessarily need to involve the CP.

If a team leader is highly concerned with the goal and highly concerned about how their team members feel, the outcome is usually teamwork.



Ask cadets why they think teamwork would occur. Ask cadets to provide one or two examples, from a leadership perspective, when they have seen teamwork occur. The examples do not necessarily need to involve the CP.



Every leadership opportunity within the CP has been designed to promote teamwork.

CONFIRMATION OF TEACHING POINT 2

QUESTIONS:

- Q1. What are the two main things on which a team leader needs to focus while leading a team?
- Q2. If a team leader is not focused on the goal and is not focused on their team members, what is usually the outcome?
- Q3. What has every leadership opportunity within the CP been designed to promote?

ANTICIPATED ANSWERS:

- A1. The team leader needs to focus on the team members and on the goal.
- A2. If a team leader is not focused on the goal and is not focused on their team members, the outcome is usually chaos.
- A3. Every leadership opportunity within the CP has been designed to promote teamwork.

Teaching Point 3

Describe leadership approaches.

Time: 15 min

Method: Interactive Lecture

LEADERSHIP APPROACHES

There are three main leadership approaches in the CP. They are:

- control,
- coach and
- empower.

Each leadership approach is based on balancing the concern for the relationship with team members for the concern for accomplishing the task.



Distribute Attachment B to each cadet.

Key Aspects of the Control Approach

Key aspects of the control approach are:

- The team leader defines the roles and tasks for the team members. The team leader gives the team members clear direction and supervises them closely.
- The team leader provides detailed explanations on what needs to be done and gives team members the information they need to know on how to do the task.
- Communication is mainly one-way.

Key Aspects of the Coach Approach

Key aspects of the coach approach are:

- The roles and tasks are still defined by the team leader but ideas and suggestions are solicited from team members.
- The team leader provides information and opinions but supports the team to develop possible solutions to problems while the final decision remains with the team leader.
- The team leader encourages team members to assume responsibility.
- Communication is mainly two-way.

Key Aspects of the Empower Approach

Key aspects of the empower approach are:

- The team leader empowers team members to make decisions and take action in areas where the team members have experience and expertise.
- Team members can operate independently and have a strong sense of responsibility but know when to seek assistance from the team leader.
- Communication is mainly two-way.

Selecting the Approach

Each of the three leadership approaches may be equally effective. The approach selected must be based on the leadership assignment and / or appointment and the leadership team.

The factors to be considered when looking at the leadership assignment / appointment are:

- the level of simplicity of the task; and
- the level of safety of cadets.

The factors to be considered when looking at the leadership team are:

- the level of capability / competence of cadets; and
- the level of motivation of cadets.

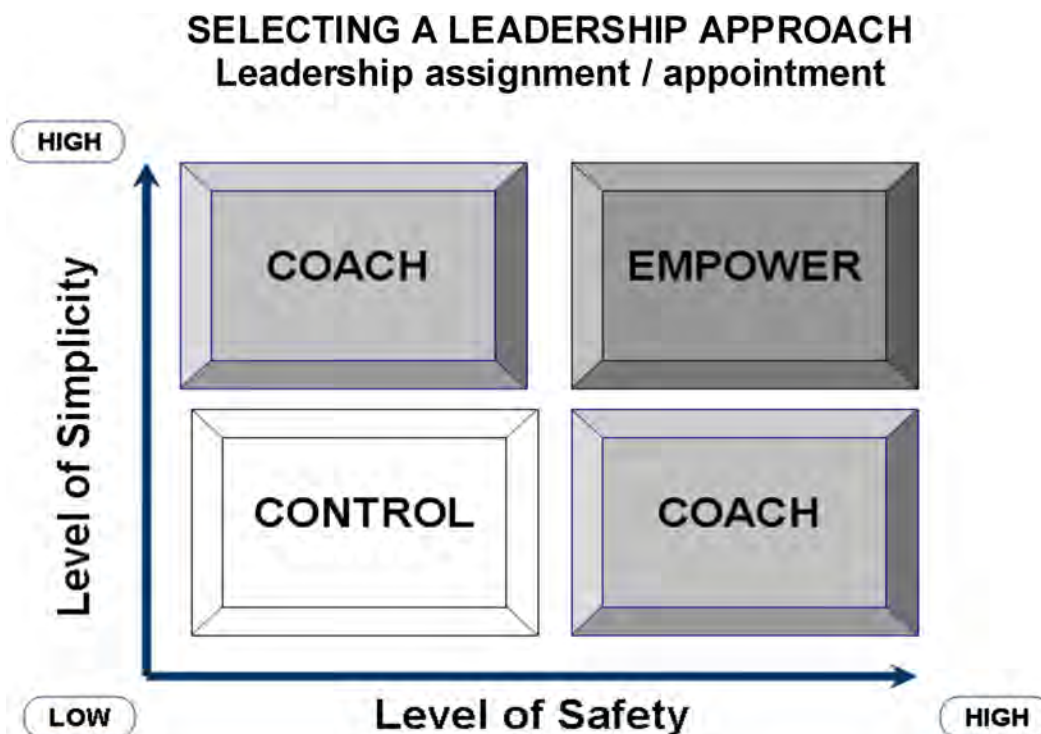

Figure 2 Selecting a Leadership Approach

Note. Created by Director Cadets 3, 2009, Ottawa, ON: Department of National Defence.

If the task is complicated and the cadets are doing something with some risk, the team leader should choose the control approach. This allows for better supervision of team members.

If the task is simple but the cadets are doing something with some risk, the team leader should choose the coaching approach. This allows the team members an opportunity to develop their leadership skills and knowledge because the team leader provides extra feedback.

If the task is complicated but the cadets are doing something without risk, the team leader should choose the coaching approach. This allows the team members an opportunity to develop their leadership skills and knowledge because the team leader provides extra feedback.

If the task is simple and the cadets are doing something without risk, the team leader should choose the empower approach. This allows the team members to develop their leadership skills and their sense of responsibility.



Have cadets give examples of when they have seen each approach used based on the simplicity of the task and the level of safety.

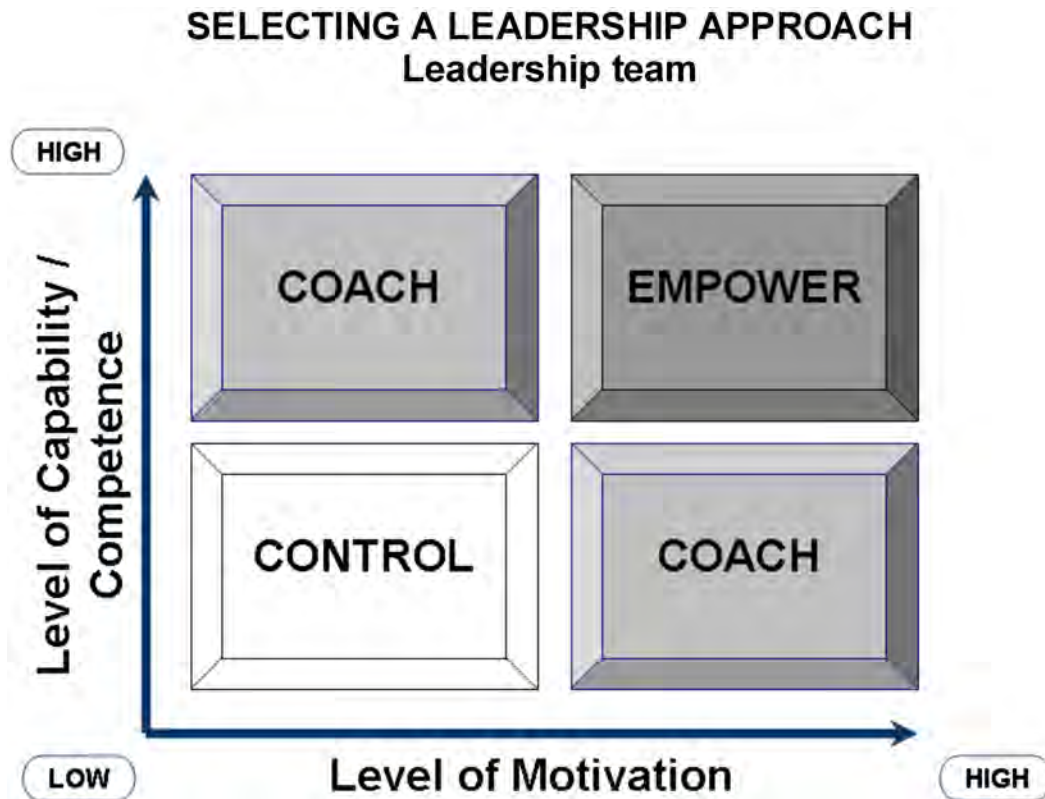

Figure 3 Selecting a Leadership Approach

Note. Created by Director Cadets 3, 2009, Ottawa, ON: Department of National Defence.

If the task is new or the task is difficult and the cadets are uninspired or apathetic, the team leader should choose the control approach. This allows for better supervision of cadets.

If the team has experience with the task but the cadets are uninspired or apathetic, the team leader should choose the coaching approach. This allows the team members an opportunity to develop their leadership skills and knowledge because the team leader provides extra feedback.

If the task is new or the task is difficult, but the cadets are inspired and enthusiastic, the team leader should choose the coaching approach. This allows the team members an opportunity to develop their leadership skills and knowledge because the team leader provides extra feedback.

If the team has experience with the task, and the cadets are inspired and enthusiastic, the team leader should choose the empower approach. This allows the team members to develop their leadership skills and their sense of responsibility by giving opportunities to operate independently.



Have cadets give examples of when they have seen each approach used based on the capability / competence of the team and the level of motivation.

CONFIRMATION OF TEACHING POINT 3**QUESTIONS:**

- Q1. Name the three leadership approaches used in the CP.
- Q2. Which leadership approach is based on one-way communication?
- Q3. What are the four topics that must be considered when selecting a leadership approach?

ANTICIPATED ANSWERS:

- A1. The three leadership approaches used in the CP are:
- control,
 - coach, and
 - empower.
- A2. The leadership approached based on one-way communication is control.
- A3. The four factors that must be considered when selecting a leadership approach are:
- the level of simplicity of the task;
 - the level of safety of cadets;
 - the level of capability / competence of cadets; and
 - the level of motivation of cadets.

Teaching Point 4

Conduct an activity where cadets will explain what leadership approach they would select and why for a given scenario.

Time: 20 min

Method: In-Class Activity

ACTIVITY**OBJECTIVE**

The objective of this activity is to have the cadets explain what leadership approach would be selected and why for a given scenario.

RESOURCES

Scenarios.

ACTIVITY LAYOUT

Nil.

ACTIVITY INSTRUCTIONS

1. Distribute a scenario located at Attachment C to each cadet.
2. Allow the cadets two minutes to read and think about the scenario.

3. Have the cadets select what leadership approach they would use to complete the scenario.
4. Have one cadet read their scenario out loud and explain which leadership approach they have selected and why. The explanation of the selection must be based on the information provided during TP3.
5. Allow the other cadets to comment on the choice and reasons.
6. Repeat Steps 4 and 5 until each cadet has had a turn.

SAFETY

Nil.

CONFIRMATION OF TEACHING POINT 4

The cadets' participation in the activity will serve as the confirmation of this TP.

END OF LESSON CONFIRMATION

| | |
|---|---|
|  | Distribute the handout located at Attachment D to each cadet. |
|---|---|

The cadets' participation in the in-class activity will serve as the confirmation of this lesson.

CONCLUSION

HOMEWORK / READING / PRACTICE

Nil.

METHOD OF EVALUATION

This EO is assessed IAW A-CR-CCP-704/PG-001, *Gold Star Qualification Standard and Plan*, Chapter 3, Annex B, 403 PC.

CLOSING STATEMENT

In every leadership opportunity, the effective team leader will use a leadership approach that enables the team leader to have a positive relationship with their team members and to accomplish tasks. Selecting and implementing leadership approaches is a life-long transformational leadership skill.

INSTRUCTOR NOTES / REMARKS

Cadets will select leadership approaches during leadership assignments and leadership appointments throughout the training year.

REFERENCES

C0-115 ISBN 0-7879-4059-3 van Linden, J. A., & Fertman, C. I. (1998). *Youth leadership*. San Francisco, CA: Jossey-Bass Inc., Publishers.

C0-410 The ASPIRA Association. (2009). *Module #5: Defining leadership styles*. Retrieved on February 12, 2009, from http://www.aspira.org/files/documents/youthdev08/U_V_M_5_dls.pdf

C0-413 University of Arkansas, Division of Agriculture, Cooperative Extension Service. (2006). *4-H volunteer leaders' series: The enabler—A leadership style*. Retrieved February 18, 2009, from http://www.uaex.edu/other_areas/publications/PDF/4HCD2.pdf

THIS PAGE INTENTIONALLY LEFT BLANK

OUTCOMES AS A RESULT OF THE TEAM LEADER'S FOCUS

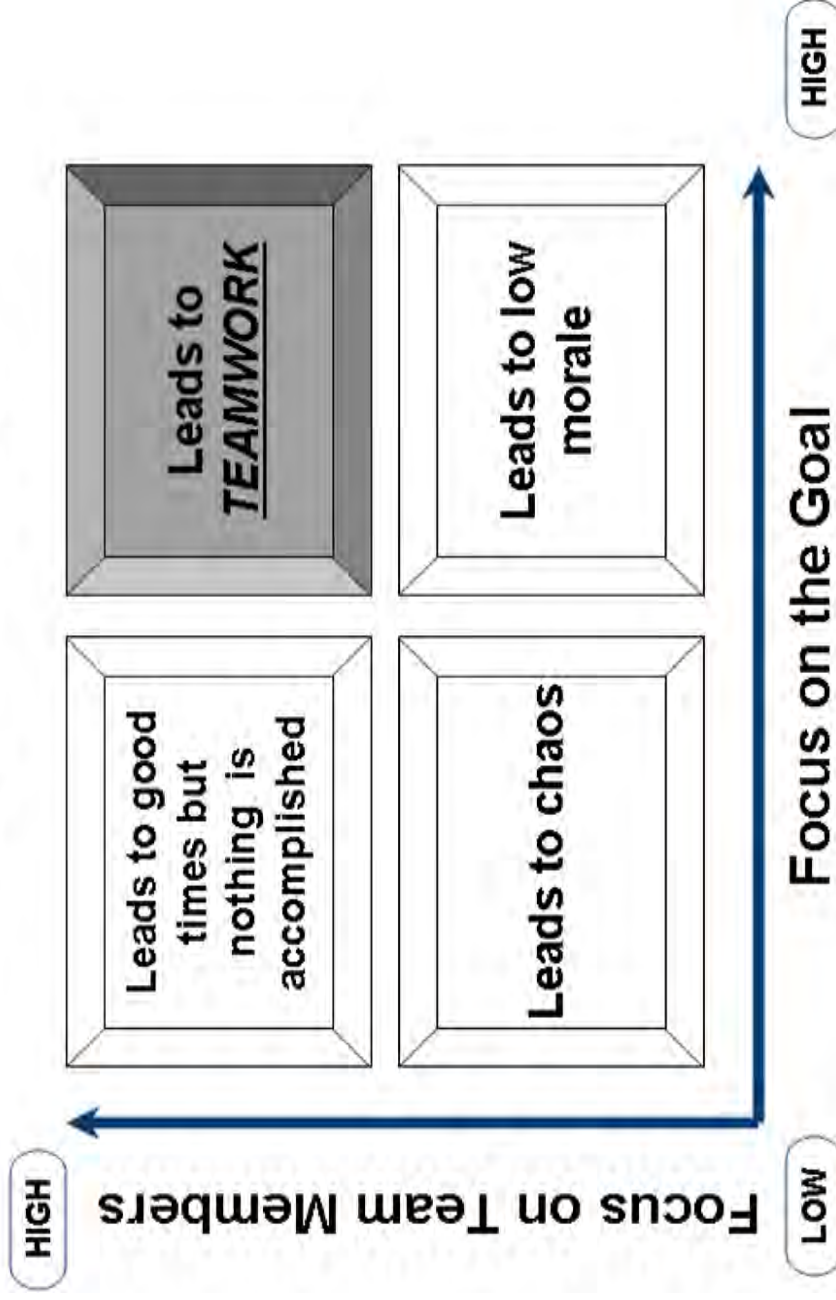

Figure A-1 Outcome as a Result of the Team Leader's Focus

Note. Created by Director Cadets 3, 2009, Ottawa, ON: Department of National Defence

THIS PAGE INTENTIONALLY LEFT BLANK

KEY ASPECTS OF EACH LEADERSHIP APPROACH



Key aspects of this approach:

- The leader defines the roles and tasks for the team members, gives them clear direction and supervises them closely.
- The leader provides detailed explanations on what needs to be done and gives the team members the information they need on how to do the task.
- Communication is mainly one-way.



Key aspects of this approach:

- The roles and tasks are still defined by the leader but ideas and suggestions are solicited from team members.
- The leader provides information and opinions but supports the team to develop possible solutions to problems while the final decision remains with the leader.
- The leader encourages members of the team to assume responsibility.
- Communication is mainly two-way.

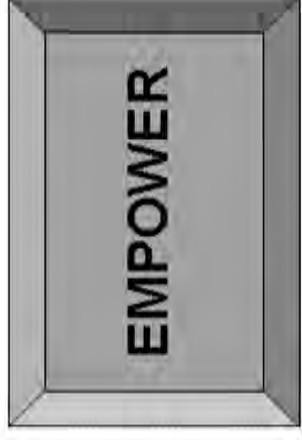

Key aspects of this approach:

- The leader empowers members of the team to make decisions and take action in areas where they have experience and expertise.
- Members of the team can operate independently and have a strong sense of responsibility but know when to seek assistance from the leader.
- Communication is mainly two-way.

Figure B-1 Key Aspects of Leadership Approaches

Note. Created by Director Cadets 3, 2009, Ottawa, ON: Department of National Defence

SELECTING A LEADERSHIP APPROACH

Leadership assignment / appointment

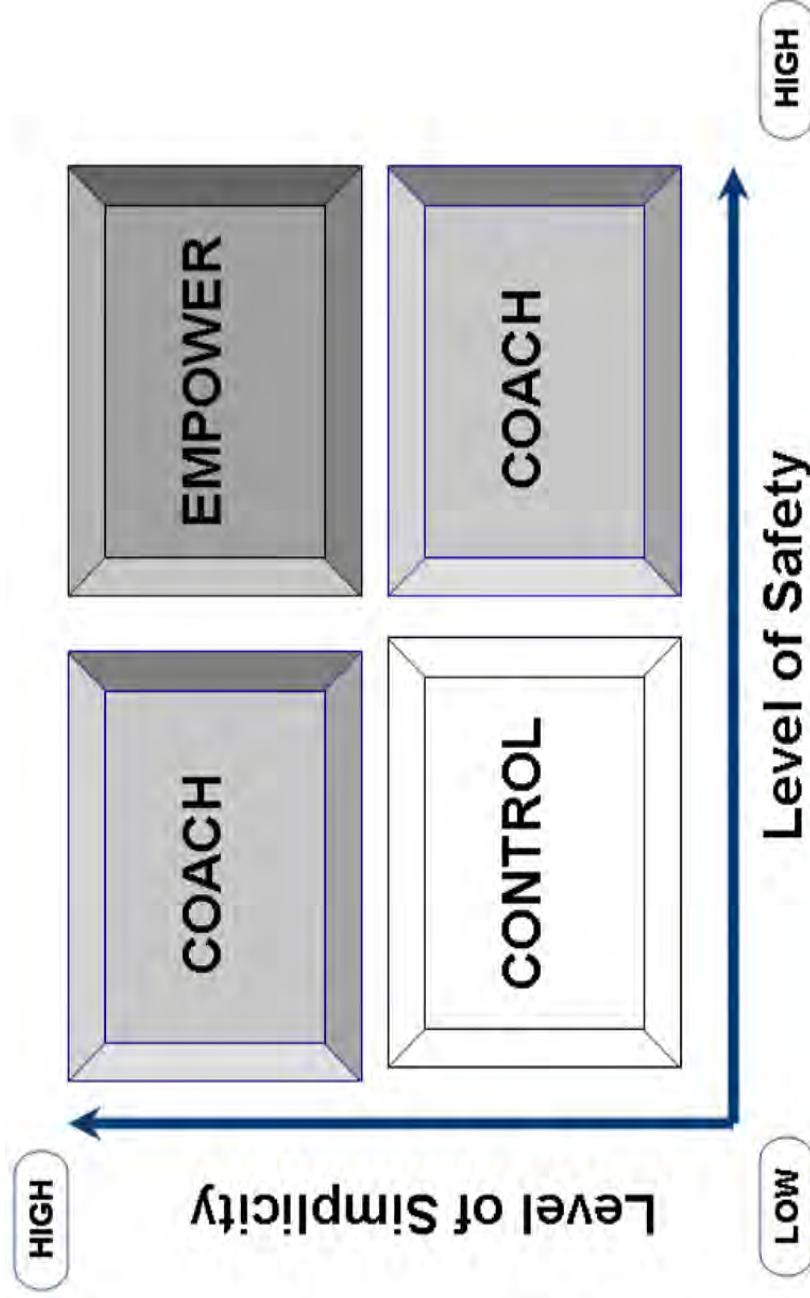

Figure B-2 Selecting a Leadership Approach

Note. Created by Director Cadets 3, 2009, Ottawa, ON: Department of National Defence

SELECTING A LEADERSHIP APPROACH

Leadership team

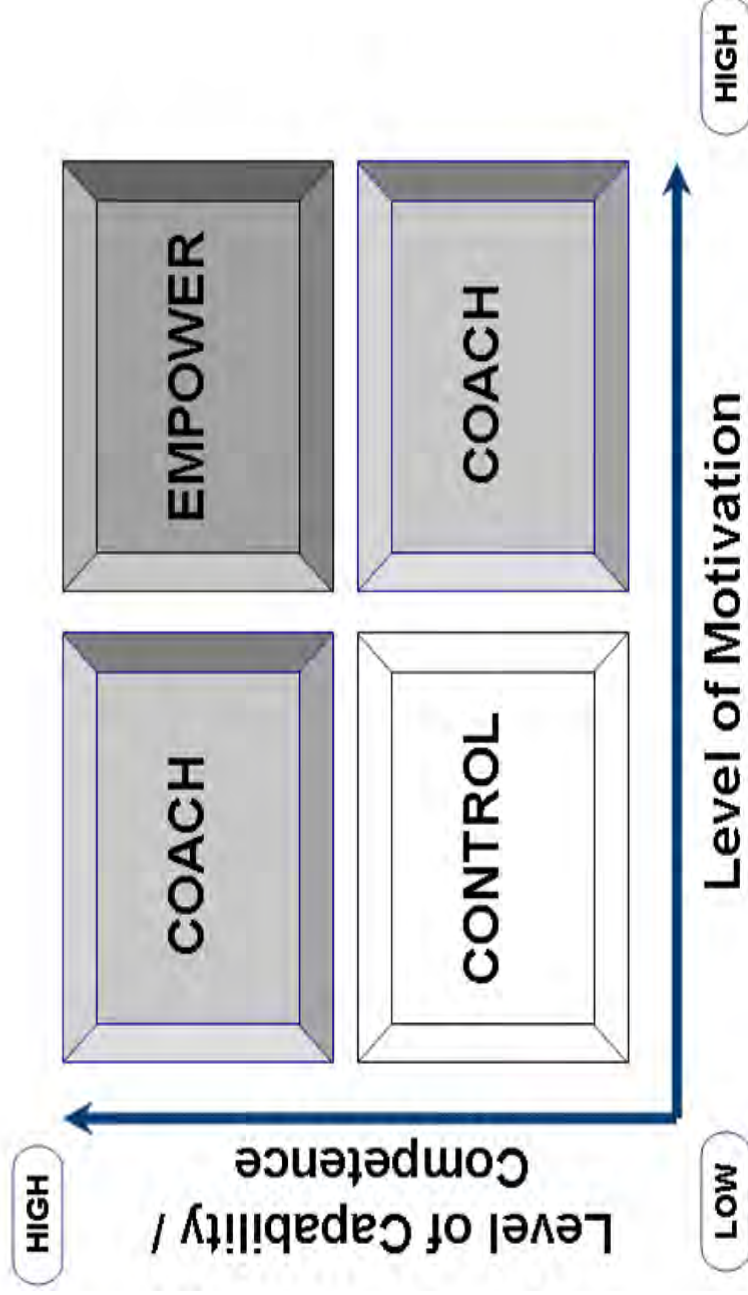

Figure B-3 Selecting a Leadership Approach

Note. Created by Director Cadets 3, 2009, Ottawa, ON: Department of National Defence

THIS PAGE INTENTIONALLY LEFT BLANK

SCENARIOS

SCENARIO #1

You and your team have been tasked with providing the Green Star cadets with one hour of team-building games. This activity will take place next parade night.

SCENARIO #2

You and your team have been tasked with setting up two classrooms. The class will begin in 10 minutes.

SCENARIO #3

You and your team have been tasked with operating the canteen at breaks. The canteen has not been stocked and must be ready to go in two weeks.

SCENARIO #4

You and your team have been tasked with putting away all the flags, poles and a dais from the Commanding Officer's parade. The parade will be over in two hours.

SCENARIO #5

You and your team have been tasked with taking attendance of all 13-year-old cadets before everyone departs the building. The parade night ends in 30 minutes.

SCENARIO #6

You and your team have been tasked with ensuring all lights have been turned off and all inner doors are locked at the end of every parade night.

SCENARIO #7

You and your team have been tasked with providing Green Star cadets with tutoring in how to wear their uniforms throughout the training year.

SCENARIO #8

You and your team have been tasked with conducting one sports activity to be held during the next parade night.

THIS PAGE INTENTIONALLY LEFT BLANK

TRANSACTIONAL AND TRANSFORMATIONAL LEADERSHIP

Transactional leadership. Leaders exchange promises of rewards and benefits to team members so the team members will fulfill agreements with the leaders. This type of leadership is task-oriented. The leader sets the rules and procedures to complete a task and the team members comply with the rules and follow the procedures to accomplish the task.

Transactional Leadership:

- Values problem and solution identification.
- Makes decisions – even if everyone has not been heard – in order to move forward.
- Uses standards and principles as guides in decision making.
- Develops the self to be a better decision maker for the group.
- Gets things done.
- Recognizes the importance of the product.
- Takes charge (personal power).

Transformational leadership. Focuses on the process of being a leader by helping team members transform themselves from followers into leaders. Transformational leadership involves assisting team members to transcend their own self-interest for the good of the group, organization or society; to consider their long-term needs to develop themselves, rather than their immediate needs; and generally, to become more aware of what is really important.

Transformational Leadership:

- Values the participation and contribution of others.
- Takes all viewpoints and advice into account before making a decision.
- Considers individuals within their contexts and situations.
- Uses individuals to test decisions.
- Develops the self first to be a better contributor to the group.
- Learns from experiences to generalize to 'real life'.
- Recognizes the importance of the process.
- Shares leadership (group power).



Leadership within the cadet program has been designed to create transformational leadership. Transformational leadership enables the Cadet Program (CP) to meet its aim of developing in youth the attributes of good citizenship and leadership.

Transactional leadership focuses on the skills and tasks associated with leadership, such as public speaking, writing, delegating authority, leading meetings and making decisions. It is what people who are leaders do. Transformational leadership focuses on the process of leadership and what it means to be a leader. It is concerned with how individuals use their abilities to influence people. Think of the main difference between transactional and transformational leadership as doing leadership tasks versus being a leader.



**COMMON TRAINING
GOLD STAR
INSTRUCTIONAL GUIDE**



SECTION 3

EO M403.03 – MOTIVATE TEAM MEMBERS

Total Time:

60 min

PREPARATION

PRE-LESSON INSTRUCTIONS

Resources needed for the delivery of this lesson are listed in the lesson specification located in A-CR-CCP-704/PG-001, *Gold Star Qualification Standard and Plan*, Chapter 4. Specific uses for said resources are identified throughout the instructional guide within the TP for which they are required.

Review the lesson content and become familiar with the material prior to delivering the lesson.

Photocopy the handouts located at Attachments A, B and C for each cadet.

PRE-LESSON ASSIGNMENT

Nil.

APPROACH

An in-class activity was chosen for TP 1 as it is an interactive way to provoke thought and stimulate interest among cadets about advantages and disadvantages of extrinsic and intrinsic motivators.

An interactive lecture was chosen for TP 2 to orient the cadets to encourage intrinsic motivation.

A group discussion was chosen for TP 3 as it allows the cadets to interact with their peers and share their knowledge, experiences, opinions and feelings about when and how to motivate team members.

INTRODUCTION

REVIEW

Nil.

OBJECTIVES

By the end of this lesson the cadet shall motivate team members.

IMPORTANCE

It is important for cadets to motivate team members because motivation is the key ingredient for success in the cadet organization. One of the duties of a team leader is to motivate team members to succeed to accomplish goals. Motivating team members also may encourage team members to develop new knowledge and skills. In addition, recognizing team members for the effort they put toward a task makes them feel appreciated.

Teaching Point 1

Conduct an in-class activity where the cadets will explain advantages and disadvantages of extrinsic and intrinsic motivators to each other.

Time: 20 min

Method: In-Class Activity

ACTIVITY**OBJECTIVE**

The objective of this activity is to have the cadets explain the advantages and disadvantages of extrinsic and intrinsic motivators to each other.

RESOURCES

- Two pieces of flip chart paper,
- Two markers,
- Extrinsic Motivators handout located at Attachment A, and
- Intrinsic Motivators handout located at Attachment B.

ACTIVITY LAYOUT

Nil.

ACTIVITY INSTRUCTIONS

1. Divide the class into two groups.
2. Distribute the handout located at Attachment A to group A.
3. Distribute the handout located at Attachment B to group B.
4. Have each group read and complete their handout for two minutes.
5. Have group A list the examples of extrinsic motivators from their handout on the flip chart paper.
6. Have group B list the examples of intrinsic motivators from their handout on the flip chart paper.
7. After 10 minutes, have each cadet from group A find a cadet from group B with whom they will share the information.
8. Have each cadet from group A explain what extrinsic motivators are, their advantages and disadvantages, and give examples to the cadet from group B. The cadet from group B must paraphrase the answers from the group A cadet.
9. Have each cadet from group B explain what intrinsic motivators are, their advantages and disadvantages, and give examples to the cadet from group A. The cadet from group A must paraphrase the answers from the group B cadet.
10. Distribute the handout located at Attachment B to the cadets from group A. Distribute the handout located at Attachment A to the cadets from group B.

SAFETY

Nil.

CONFIRMATION OF TEACHING POINT 1

The cadets' participation in the activity will serve as the confirmation of this TP.

Teaching Point 2

Explain why team leaders should encourage intrinsic motivation.

Time: 5 min

Method: Interactive Lecture

WHY TEAM LEADERS SHOULD ENCOURAGE INTRINSIC MOTIVATION



Display the following statement on a presentation aid (eg, whiteboard / flip chart / OHP / multimedia projector), "Leaders do things right and they do the right things."

Have the cadets reflect upon the saying while thinking about whether extrinsic or intrinsic motivation should be used by their team members.

As a team leader, cadets should lead by example and be intrinsically motivated to accomplish goals and tasks. Although this may be difficult, team leaders need to accomplish their goals and believe the goals are worth accomplishing.

When a team leader leads by example, the team members may also realize that accomplishing goals and tasks are a good and right thing to do.

When a team leader displays intrinsic motivation, team members may realize that intrinsic motivation is an attribute to be imitated. Any positive attribute that a team member imitates may assist the team member in becoming a better leader in the future.

As an example, a team leader will wear their uniform correctly because it is the right thing to do. A team leader takes pride in their uniform and does not need to be given an external reward to do this. Team members see this behaviour and want to be like their team leader and may not continue to need external rewards. Team members begin to imitate the team leader and become intrinsically motivated.



Have the cadets give other examples of how team leaders have encouraged intrinsic motivation in their team members.

It is important to remember that extrinsic motivation will boost morale for a only short period of time.

CONFIRMATION OF TEACHING POINT 2

QUESTIONS:

- Q1. When team leaders accomplish goals and tasks and display motivation while doing so, what message are they sending to their team members?
- Q2. What happens when a team leader displays intrinsic motivation?
- Q3. Give an example of a team leader encouraging intrinsic motivation in team members.

ANTICIPATED ANSWERS:

- A1. They are sending the message that they believed the goals and tasks were worth accomplishing.
- A2. When a team leader displays intrinsic motivation, team members realize that intrinsic motivation is an attribute to be imitated.
- A3. Answers will vary.

Teaching Point 3

Conduct a group discussion about when and how team leaders motivate team members.

Time: 25 min

Method: Group Discussion

BACKGROUND KNOWLEDGE



The purpose of the group discussion is to draw the following information from the group using the tips for answering / facilitating discussion and the suggested questions provided.

WHEN TEAM LEADERS MOTIVATE TEAM MEMBERS

The team leader must motivate team members. The skill of knowing when your team members need to be motivated will develop over time. As a team leader during Gold Star, it is important that you motivate team members at every opportunity.

HOW TEAM LEADERS MOTIVATE TEAM MEMBERS

One of the most common methods used to motivate team members is to use praise. Verbal praise is a very effective way to motivate team members.

Verbal praise may be used as positive feedback before, during and at the end of tasks. If possible, team leaders should praise team members in front of others as it makes team members feel valued.

Praising Effort and Perseverance During a Task

It is very important for team leaders to praise team members for their effort and perseverance during a task. Encouraging and caring about team members is an important aspect of being a leader.

Praising the use of Different Strategies During a Task

Team leaders should praise team members when they use different strategies to during a task. Creative thinking is an important tool for leaders.

Praising Improvement During a Task

When team members have completed a task before and they complete the task again more effectively or efficiently, praise should be given. Leaders and team members should always try to improve their performance.

Encouraging the Development of Knowledge and Skills

Team leaders should encourage team members when they learn something new. Everything new that a team member learns may be used at some point to assist the team.

Praising the Completion of a Task

When team members complete a task, praise should be given. It is important to recognize dedication shown in seeing a task through to completion.

Thanking Team Members for Their Endeavours

Team leaders should try to recognize each team member for their contribution in the completion of a task. Making team members feel special is a great way to win even more cooperation from the team.

Giving credit for the completion of tasks to the team rather than yourself

When team leaders are given credit for completing a task, they should ensure that credit is given also to the team members. Recognizing the team for their accomplishments boosts the team's morale.



When team leaders model praise correctly, they lead by example. This may help team members begin to use the same strategies, thus reinforcing motivation.

GROUP DISCUSSION



TIPS FOR ANSWERING / FACILITATING DISCUSSION:

- Establish ground rules for discussion, eg, everyone should listen respectfully; don't interrupt; only one person speaks at a time; no one's ideas should be made fun of; you can disagree with ideas but not with the person; try to understand others as much as you hope they understand you; etc.
- Sit the group in a circle, making sure all cadets can be seen by everyone else.
- Ask questions that will provoke thought; in other words avoid questions with yes or no answers.
- Manage time by ensuring the cadets stay on topic.
- Listen and respond in a way that indicates you have heard and understood the cadet. This can be done by paraphrasing their ideas.
- Give the cadets time to respond to your questions.
- Ensure every cadet has an opportunity to participate. One option is to go around the group and have each cadet answer the question with a short answer. Cadets must also have the option to pass if they wish.
- Additional questions should be prepared ahead of time.

SUGGESTED QUESTIONS:

- Q1. Give some examples of when a team leader may praise their team members.
- Q2. Give some examples of what a team leader might say to praise their team members.
- Q3. Give some examples of when you were praised by team members, team leaders, activity managers, officers or adults?

Q4. How do you feel when you are praised by team members, team leaders, activity managers, officers or adults?

Q5. Why is praise an important tool for motivating team members?



Other questions and answers will develop throughout the group discussion. The group discussion should not be limited to only those suggested.



Reinforce those answers given and comments made during the group discussion, ensuring the teaching point has been covered.

CONFIRMATION OF TEACHING POINT 3

The cadets' participation in the group discussion will serve as the confirmation of this TP.

END OF LESSON CONFIRMATION

The cadets' participation in the group discussion in TP 4 will serve as the confirmation of this lesson.



Distribute the handout located at Attachment C to each cadet.

CONCLUSION

HOMEWORK / READING / PRACTICE

Nil.

METHOD OF EVALUATION

This EO is assessed IAW A-CR-CCP-704/PG-001, *Gold Star Qualification Standard and Plan*, Chapter 3, Annex B 403 PC.

CLOSING STATEMENT

One of the duties of a team leader is to motivate team members to succeed to accomplish goals. Motivating team members also may encourage them to develop new knowledge and skills. In addition, recognizing team members for the effort they put towards a task makes them feel appreciated.

INSTRUCTOR NOTES / REMARKS

Nil.

REFERENCES

- C0-245 ISBN 1-58062-513-4 Adams, B. (2001). *The everything leadership book*. Avon, MA: Adams Media.
- C0-401 ISBN 0-7879-6068-3 Hesselbein, F., & Johnston, R. (2002). *A leader to leader guide: On mission and leadership*. San Francisco, CA: Jossey-Bass Publishing.
- C0-411 Dweck, C. S. (2007). The perils and promises of praise. *Education Leadership*, 65(2), 34-39.
- C0-414 Bainbridge, C. (2009). About.com: Gifted children. *Extrinsic Motivation*. Retrieved on February 26, 2009, from <http://giftedkids.about.com/od/glossary/g/extrinsic.htm>
- C0-415 Bainbridge, C. (2009). About.com: Gifted children. *Intrinsic Motivation*. Retrieved on February 26, 2009, from <http://giftedkids.about.com/od/glossary/g/intrinsic.htm>

THIS PAGE INTENTIONALLY LEFT BLANK

EXTRINSIC MOTIVATORS

Extrinsic motivators refer to motivators that come from outside an individual. The motivating factors are external and are given as rewards. Rewards may include grades, stickers, trophies and badges.

Advantage

Extrinsically motivated people may work hard on a task even when they have little interest in the task. The extrinsically motivated person gets satisfaction because they will receive some kind of reward. These rewards provide satisfaction and pleasure that the task itself may not provide.

Disadvantage

The disadvantage to using extrinsic motivators is that these rewards only produce short-term results and a brief boost in morale. Over time, extrinsically motivated people are only satisfied when they receive some kind of reward.

List some examples of extrinsic motivators:

THIS PAGE INTENTIONALLY LEFT BLANK

INTRINSIC MOTIVATORS

Intrinsic motivators refer to motivators that come from inside an individual rather than from any external or outside reward.

Advantage

Motivation comes from the pleasure the person gets from the task itself, the sense of satisfaction in completing the task or a sense of satisfaction from working on the task. This means that no reward is required.

Disadvantage

Intrinsic motivation is a learned behaviour and it takes some time to develop. Some individuals will take longer to be motivated by their inner drives rather than physical rewards.

List some examples of intrinsic motivators:

THIS PAGE INTENTIONALLY LEFT BLANK

WHEN TEAM LEADERS MOTIVATE TEAM MEMBERS

The team leader must motivate team members. The skill of knowing when your team members need to be motivated will develop over time. As a team leader during Gold Star, it is important that you motivate team members at every opportunity.

HOW TEAM LEADERS MOTIVATE TEAM MEMBERS

The team leader must motivate team members. The skill of knowing when your team members need to be motivated will develop over time. As a team leader during Gold Star, it is important that you motivate team members at every opportunity.

HOW TEAM LEADERS MOTIVATE TEAM MEMBERS

One of the most common methods used to motivate team members is to use praise. Verbal praise is a very effective way to motivate team members.

Verbal praise may be used as positive feedback before, during and at the end of tasks. If possible, team leaders should praise team members in front of others as it makes team members feel valued.

Praising Effort and Perseverance During a Task

It is very important for team leaders to praise team members for their effort and perseverance during a task. Encouraging and caring about team members is an important aspect of being a leader.

Praising the use of Different Strategies During a Task

Team leaders should praise team members when they use different strategies to during a task. Creative thinking is an important tool for leaders.

Praising Improvement During a Task

When team members have completed a task before and they complete the task again more effectively or efficiently, praise should be given. Leaders and team members should always try to improve their performance.

Encouraging the Development of Knowledge and Skills

Team leaders should encourage team members when they learn something new. Everything new that a team member learns may be used at some point to assist the team.

Praising the Completion of a Task

When team members complete a task, praise should be given. It is important to recognize dedication shown in seeing a task through to completion.

Thanking Team Members for Their Endeavours

Team leaders should try to recognize each team member for their contribution in the completion of a task. Making team members feel special is a great way to win even more cooperation from the team.

Giving credit for the completion of tasks to the team rather than yourself

When team leaders are given credit for completing a task, they should ensure that credit is given also to the team members. Recognizing the team for their accomplishments boosts the team's morale.

THIS PAGE INTENTIONALLY LEFT BLANK



**COMMON TRAINING
GOLD STAR
INSTRUCTIONAL GUIDE**



SECTION 4

EO M403.04 – PROVIDE FEEDBACK TO TEAM MEMBERS

Total Time:

60 min

PREPARATION

PRE-LESSON INSTRUCTIONS

Resources needed for the delivery of this lesson are listed in the lesson specification located in A-CR-CCP-704/PG-001, *Gold Star Qualification Standard and Plan*, Chapter 4. Specific uses for said resources are identified throughout the instructional guide within the TP for which they are required.

Review the lesson content and become familiar with the material prior to delivering the lesson.

Photocopy the scenarios located at Attachment A. Cut out the scenarios and distribute one to each cadet. If there are more cadets than scenarios provided, multiple cadets may be given the same scenario.

Photocopy the Effective Feedback handout located at Attachment B for each cadet.

PRE-LESSON ASSIGNMENT

Nil.

APPROACH

An in-class activity was chosen for TPs 1 and 5 as an interactive way to provoke thought, and to stimulate an interest among cadets about feedback.

An interactive lecture was chosen for TPs 2–4 to orient the cadets to giving effective feedback.

INTRODUCTION

REVIEW

Review what “feedback” is. This is previously discussed in Silver Star and can be summarized as follows:

Feedback is a reactive form of communication. It is a response to some kind of action or input. Feedback may:

- answer a question;
- fulfill a request for information;
- reply to or rebut a point of discussion;
- suggest a revision during a task; or
- evaluate task or job performance.

OBJECTIVES

By the end of this lesson the cadet shall have provided feedback to team members.

IMPORTANCE

It is important for cadets to provide feedback because it is an essential skill for a team leader. Feedback is given to help team members improve. Providing feedback correctly to team members gives the team members regular guidance to complete their tasks.

Teaching Point 1**Have the cadets brainstorm and prepare a list of opportunities when feedback should be provided.**

Time: 5 min

Method: In-Class Activity

ACTIVITY**OBJECTIVE**

The objective of this activity is to have cadets brainstorm and prepare a list of opportunities when feedback should be provided.

RESOURCES

- Two pieces of flip chart paper, and
- Two markers.

ACTIVITY LAYOUT

Nil.

ACTIVITY INSTRUCTIONS

1. Divide the cadets into two groups.
2. Give each group a flip chart paper and marker.
3. Have each group brainstorm and record on the flip chart paper a list of opportunities when feedback should be provided.
4. Have one member of each group share their list with the class.

SAFETYNil

CONFIRMATION OF TEACHING POINT 1

The cadets' participation in the activity will serve as the confirmation of this TP.

Teaching Point 2**Explain the principles of effective feedback.**

Time: 10 min

Method: Interactive Lecture

PRINCIPLES OF EFFECTIVE FEEDBACK

Feedback may be given to the team as a whole or it may be given to individual team members. Giving feedback well is a skill. Feedback is a practical method for giving team members feedback, and when giving feedback, it should be:

Frequent. Frequent means occurring often or in close succession. Team leaders should give feedback often. After giving feedback, a team leader should note if the team members are responding. If the feedback is not being used by the team members, it may need to be restated in a different way.

Accurate. Accurate means careful, precise or lacking errors. Accurate feedback means giving feedback that is truthful and fact-based. Accurate feedback should be correct, balanced and appropriate; if not, team members may begin to lose respect for the team leader as every instance of feedback has an effect on the team members' trust.

Specific. Specific means clearly defined, definite or precise. Specific feedback means giving feedback that is detailed and clear-cut. Telling team members what they do right and wrong is not specific enough; the team leader must also tell team members exactly what steps are necessary to improve their performance. This is usually done by asking reflective questions to the team members so they generate suggestions for improvement. When giving specific feedback, team leaders should set concrete goals and deadlines for team members.

Timely. Timely means opportune, occurring, done or made at suitable or appropriate time. Timely feedback means giving feedback at the right time. The closer in time the feedback follows the performance, the more impact it will have on team members because the performance and the feedback are tied closely together.



Feedback must be based on the team member's behaviour and / or performance—not the person or their personality.



Ask cadets to give examples of when feedback has been given to them that was frequent, accurate, specific, and timely.

CONFIRMATION OF TEACHING POINT 2

QUESTIONS:

- Q1. What does frequent feedback mean?
- Q2. What does accurate feedback mean?
- Q3. What does specific feedback mean?
- Q4. What does timely feedback mean?

ANTICIPATED ANSWERS:

- A1. Frequent feedback means giving feedback to team members often.
- A2. Accurate feedback means giving feedback that is truthful and fact-based.
- A3. Specific feedback means giving feedback that is detailed and clear-cut.
- A4. Timely feedback means giving feedback at the right time.

Teaching Point 3**Explain the ground rules for providing feedback.**

Time: 10 min

Method: Interactive Lecture

GROUND RULES FOR PROVIDING FEEDBACK

The following ground rules for providing feedback may enable the team leader to give helpful, constructive feedback, without creating conflict or confrontational behaviour with team members.

Focusing on What is Observed

Team leaders should give feedback based on what they see because it is factual. What team leaders believe is based on supposition and inference; it is an interpretation of what they have seen. When team leaders give feedback based on interpretation rather than fact, the interpretation may be wrong.

For example:

A team member is looking at their boots as the team leader speaks to him. The team leader says "Pay attention." This is incorrect because the team leader is inferring that the team member is not paying attention. The team leader should say "[rank and name] I would like for you to look at me when I speak to you." This statement focuses on what the team leader saw.

Focusing on Behaviour

Team leaders should give feedback based on the behaviour of team members, not on the person or personality of a team member.

For example:

A team leader observes a team member slouching against a wall. The team leader says "Don't be lazy." This is incorrect because the team leader is making judgment on the team member's personality. The team leader should say "Please stand up straight, [rank and name]." This statement does not make any judgment but focuses directly on the behaviour required by the team member.

Keeping it Neutral

Team leaders should give feedback that is unbiased and does not make judgments. When a team leader is objective when giving feedback, the team members can determine for themselves the effect of their behaviour. This presents a more meaningful learning opportunity for team members.

For example:

The team leader observes a team member arriving late again. The team leader says "You are late a lot." This is incorrect because the team leader has made a judgment on how many times the team member has been late. The team leader should say "You have been late three times in the past two months." This is a statement of fact.

Using it to Inform

Team leaders should give feedback that is enlightening and does not advise. When the team leader gives feedback, it leaves the team members free to draw their own conclusions. This freedom allows the team members to decide what actions are necessary to change their behaviour.

For example:

A team leader does an inspection and observes that a team member's boots are not up to standard. The team leader says "Everyone needs to work on their boots." The team leader should say "Our team's boots are not meeting inspection standard." This statement allows team members to decide what should be done.



If the team members cannot generate an idea, the team leader may have to explain what behaviour is required.

Making it Supportive

Team leaders should give feedback that is reassuring and not threatening. When the team leader gives feedback that is supportive, it does not sound like a put-down. The choice of language and tone must be carefully considered. Even the friendliest and best intentioned feedback can sound intimidating.

For example:

A team leader observes a team member leading a team-building activity. The team leader says "I want to talk to you about that activity." This may be perceived as frightful and ominous. The team leader should say "I thought your activity went well, but let's have a chat about making it even better." This statement starts with something positive and then offers and opportunity to discuss ways of improving.

Keeping it Simple

Team leaders should give feedback that is uncomplicated. Team members can usually only process one or two pieces of information at any one time. If team leaders overload team members with too much feedback, there is a possibility that the information will not be received. Feedback on one or two major points is more useful than feedback on six or seven minor points.

For example:

A team leader supervises as a team member conducts an inspection. The team leader notices that the team member's uniform and boots are not up to inspection standard. The team member starts the inspection at the cadet's back and continues to make errors. The team leader says "Very few things went correctly during that inspection—you look bad, you started with their backs and your comments made no sense." This is incorrect because the team leader is focusing on too many issues at once. The team leader should have said "Very few things went correctly during that inspection and we will start with your uniform." This allows the team member to focus on one behaviour at a time.

ACTIVITY

Time: 5 min

OBJECTIVE

The objective of this activity is to have the cadets identify the ground rules for providing feedback.

RESOURCES

Nil.

ACTIVITY LAYOUT

Nil.

ACTIVITY INSTRUCTIONS

1. Have the cadets find a partner.
2. Have the cadet with the earliest birthday recite one ground rule for providing feedback to their partner.

3. Have the cadet with the latest birthday recite another ground rule for providing feedback to their partner.
4. Have the cadets take turns reciting the ground rules for providing feedback until all the ground rules have been recited.

SAFETY

Nil.

CONFIRMATION OF TEACHING POINT 3

The cadets' participation in the activity will serve as the confirmation of this TP.

Teaching Point 4

Explain the steps for providing and receiving feedback.

Time: 10 min

Method: Interactive Lecture

STEPS FOR PROVIDING FEEDBACK

The purpose for providing feedback is to let team members know how they are doing and when they are not meeting expectations. Team leaders should ensure that feedback is given when team members meet and / or exceed their commitments, as well as when team members do not meet their commitments. There are five steps for providing feedback.

Planning What to Say. Team leaders need to plan what they will say during feedback using the ground rules for providing feedback. Team leaders should think ahead of time about the team member's behaviour to be discussed. Team leaders should also have suggestions for improvement; however, these ideas should only be given if the team member cannot generate suggestions for improvement themselves.

Providing Examples of Behaviours. Team leaders need to give feedback that provides examples of the behaviour that needs to change. Giving unclear or vague examples may lead to anxiety in team members because they are not sure what behaviour needs to be modified.

Allowing Time for Feedback. Once team leaders have provided examples to the team members, they should allow time for discussion. The team members may agree, disagree or provide their perspective of the situation to the team leader. The team members may need to ask for clarification of the behaviours or they may ask for suggestions to assist them in changing their behaviour.

Motivating. Once team leaders have allowed time for discussion of the feedback, team leaders should motivate the team members. The team member may be disappointed by the feedback so the team leader should encourage and stimulate them to reach their goals.

Setting a Timeline for Action and Follow-Up. Team leaders need to set a timeframe for action by the team member to check for progress on the behaviour change. Team leaders need to follow up to ensure the team members are making the corrections required.

RECEIVING FEEDBACK

In every feedback session, there must be a sender and a receiver. When receiving feedback, there are five considerations.

Seeing Each Feedback Session as a Learning Opportunity. Each time feedback is received, the feedback session should be seen as a learning opportunity because ideas are generated on how to improve performance. Whether the idea comes from the receiver or the sender, acting on suggestions usually leads to developing skills and knowledge.

Actively Listening to the Sender's Ideas. Active listening encourages the sender to present their feedback in a non-threatening environment. Active listening on the part of the receiver shows the sender that their feedback is important.

Asking for More Information if the Ideas are Not Understood. When the sender gives feedback and the ideas are not understood, the receiver should ask for more information. By asking questions for clarification, the receiver should be able to understand the sender's intent.

Being Honest About How the Feedback is Affecting One's Emotions. Receiving feedback can make the receiver feel uncomfortable. The receiver should be honest with the sender about how the feedback is affecting them. As the receiver, try not to get emotional or take the feedback personally.

Remaining Open-Minded About Future Learning Opportunities. It is important to be open-minded about future feedback. Senders may follow up on their feedback and may even provide even more feedback. The receiver should be aware of these future learning opportunities.

CONFIRMATION OF TEACHING POINT 4

QUESTIONS:

- Q1. State two of the five steps for providing feedback.
- Q2. State two of the five considerations for receiving feedback.

ANTICIPATED ANSWERS:

- A1. Planning what to say; providing examples of behaviours; allowing time for feedback; motivating; and setting a timeline for action and follow-up.
- A2. Seeing each feedback session as a learning opportunity; actively listening to the sender's ideas; asking for more information if the ideas are not understood; being honest about how the feedback is affecting one's emotions; and remaining open-minded about future learning opportunities.

Teaching Point 5

Using scenarios, have the cadets practice providing feedback to team members.

Time: 15 min

Method: In-Class Activity

ACTIVITY

OBJECTIVE

The objective of this activity is to have cadets practice providing feedback to team members.

RESOURCES

Scenarios located at Attachment A.



If there are more cadets than scenarios provided, multiple cadets may be given the same scenario.

ACTIVITY LAYOUT

Nil.

ACTIVITY INSTRUCTIONS

To give each cadet an equal opportunity to give feedback, divide the time equally between the number of cadets in the group.

1. Distribute a scenario to each cadet.
2. Give the cadets one minute to read the scenario and make notes on the feedback they wish to give. Ensure the cadets know the length of time they have to give feedback.
3. Ask for a volunteer to give their feedback.
4. Have the volunteer read their scenario and then give their feedback.
5. Repeat Steps 3 and 4 until all cadets have given their feedback.

SAFETY

Nil.

CONFIRMATION OF TEACHING POINT 5

The cadets' participation in the activity will serve as the confirmation of this TP.

END OF LESSON CONFIRMATION

The cadets' participation in the feedback activity will serve as the confirmation of this lesson.



Distribute the Effective Feedback handout located at Attachment B to each cadet.

CONCLUSION**HOMEWORK / READING / PRACTICE**

Nil.

METHOD OF EVALUATION

This EO is assessed IAW A-CR-CCP-704/PG-001, *Gold Star Qualification Standard and Plan*, Chapter 3, Annex B, 403 PC.

CLOSING STATEMENT

Providing feedback is an essential skill for a team leader. Feedback is given to help team members improve. Providing feedback correctly to team members gives the team members regular guidance to complete their tasks.

INSTRUCTOR NOTES / REMARKS

Nil.

REFERENCES

C0-258 ISBN 978-1-59869-450-5 Nigro, N. (2008). *The everything coaching and mentoring book*. (2nd ed.). Avon, MA: F+W Publications Company.

C0-403 Peeling, G. (2000). *Feedback techniques: 7 things to know about giving feedback: Trainers Guide*. Cambridgeshire, England: Fenman Limited.

C0-404 Mochal, T. (2006). *Follow these six steps when providing constructive performance feedback*. Retrieved February 5, 2009, from http://articles.techrepublic.com.com/5100-10878_11-6102736.html

C0-412 ISBN 978-0-87425-495-2 Tulgan, B. (1999). *Fast feedback* (2nd ed). Amherst, MA: HRD Press, Inc.

SCENARIOS FOR PROVIDING FEEDBACK

SCENARIO #1

One of your team members has not displayed a positive attitude toward the last three tasks assigned to him. He is complaining about having to do any work at all. His outlook is having a negative effect on the team. He is a second year cadet and wishes to go to summer training this summer.

SCENARIO #2

One of your team members has not worn her uniform to cadets twice this month. When she has worn her uniform, it has not been up to inspection standards. She is a first year cadet and does very well in her classes.

SCENARIO #3

One of your team members was tasked with setting up and tearing down a classroom for a staff meeting. He completed the task but was 10 minutes late for the set-up and 5 minutes late for the tear-down. He is always asking to be given more duties.

SCENARIO #4

One of your team members was absent from the last three parade nights and did not call to explain his absence. He is at cadets this evening. He is a first year cadet and wishes to go to summer training this summer.

SCENARIO #5

One of your team members has been late coming to class after break the last three weeks in a row. He is a volunteer at the canteen.

SCENARIO #6

One of your team members was tasked to clean up a classroom. This task was not accomplished. She is a third year cadet.

SCENARIO #7

One of your team member's hair does not meet the standard. Her hair is on her shoulders. Her uniform and boots do meet the standard.

SCENARIO #8

One of your team members has been accomplishing all tasks assigned. He has been to every parade night and volunteers for all cadet activities. He is a second year cadet and wishes to go to summer training this summer.

SCENARIO #9

One of your team members has been accomplishing three quarters of the tasks assigned. She has been to all parade nights except two. She volunteers for nearly all cadet activities. She is a second year cadet and wishes to go to summer training this summer.

SCENARIO #10

One of your team members has been accomplishing all tasks assigned and is very enthusiastic while doing them. He has been to all parade nights except two. He volunteers for nearly all cadet activities. He is a first year cadet and wishes to go to summer training this summer.

THIS PAGE INTENTIONALLY LEFT BLANK

EFFECTIVE FEEDBACK

PRINCIPLES OF EFFECTIVE FEEDBACK

Feedback is a reactive form of communication. It is a response to some kind of action or input. Feedback may:

- answer a question;
- fulfill a request for information;
- reply to or rebut a point of discussion;
- suggest a revision during a task; or
- evaluate task or job performance.

Feedback may be given to the team as a whole or it may be given to individual team members. Giving feedback well is a skill. Feedback is a practical method for giving team members feedback, and when giving feedback, it should be frequent, accurate, specific, and timely:

Frequent. Frequent means occurring often or in close succession. Team leaders should give feedback often. After giving feedback, a team leader should note if the team members are responding. If the feedback is not being used by the team members, it may need to be restated in a different way.

Accurate. Accurate means careful, precise or lacking errors. Accurate feedback means giving feedback that is truthful and fact-based. Accurate feedback should be correct, balanced and appropriate; if not, team members may begin to lose respect for the team leader as every instance of feedback has an effect on the team members' trust.

Specific. Specific means clearly defined, definite or precise. Specific feedback means giving feedback that is detailed and clear-cut. Telling team members what they do right and wrong is not specific enough; the team leader must also tell team members exactly what steps are necessary to improve their performance. This is usually done by asking reflective questions to the team members so they generate suggestions for improvement. When giving specific feedback, team leaders should set concrete goals and deadlines for team members.

Timely. Timely means opportune, occurring, done or made at suitable or appropriate time. Timely feedback means giving feedback at the right time. The closer in time the feedback follows the performance, the more impact it will have on team members because the performance and the feedback are tied closely together.

GROUND RULES FOR PROVIDING FEEDBACK

The following ground rules for providing feedback may enable the team leader to give helpful, constructive feedback, without creating conflict or confrontational behaviour with team members.

Focusing on What is Observed. Team leaders should give feedback based on what they see because it is factual. What team leaders believe is based on supposition and inference; it is an interpretation of what they have seen. When team leaders give feedback based on interpretation rather than fact, the interpretation may be wrong.

Focusing on Behaviour. Team leaders should give feedback based on the behaviour of team members, not on the person or personality of a team member.

Keeping it Neutral. Team leaders should give feedback that is unbiased and does not make judgments. When a team leader is objective when giving feedback, the team members can determine for themselves the effect of their behaviour. This presents a more meaningful learning opportunity for team members.

Using it to Inform. Team leaders should give feedback that is enlightening and does not advise. When the team leader gives feedback, it leaves the team members free to draw their own conclusions. This freedom allows the team members to decide what actions are necessary to change their behaviour.

Making it Supportive. Team leaders should give feedback that is reassuring and not threatening. When the team leader gives feedback that is supportive, it does not sound like a put-down. The choice of language and tone must be carefully considered. Even the friendliest and best intentioned feedback can sound intimidating.

Keeping it Simple. Team leaders should give feedback that is uncomplicated. Team members can usually only process one or two pieces of information at any one time. If team leaders overload team members with too much feedback, there is a possibility that the information will not be received. Feedback on one or two major points is more useful than feedback on six or seven minor points.

STEPS FOR PROVIDING FEEDBACK

The purpose for providing feedback is to let team members know how they are doing and when they are not meeting expectations. Team leaders should ensure that feedback is given when team members meet and / or exceed their commitments, as well as when team members do not meet their commitments. There are five steps for providing feedback.

Planning What to Say. Team leaders need to plan what they will say during feedback using the ground rules for providing feedback. Team leaders should think ahead of time about the team member's behaviour to be discussed. Team leaders should also have suggestions for improvement; however, these ideas should only be given if the team member cannot generate suggestions for improvement themselves.

Providing Examples of Behaviours. Team leaders need to give feedback that provides examples of the behaviour that needs to change. Giving unclear or vague examples may lead to anxiety in team members because they are not sure what behaviour needs to be modified.

Allowing Time for Feedback. Once team leaders have provided examples to the team members, they should allow time for discussion. The team members may agree, disagree or provide their perspective of the situation to the team leader. The team members may need to ask for clarification of the behaviours or they may ask for suggestions to assist them in changing their behaviour.

Motivating. Once team leaders have allowed time for discussion of the feedback, team leaders should motivate the team members. The team member may be disappointed by the feedback so the team leader should encourage and stimulate them to reach their goals.

Setting a Timeline for Action and Follow-Up. Team leaders need to set a timeframe for action by the team member to check for progress on the behaviour change. Team leaders need to follow up to ensure the team members are making the corrections required.

RECEIVING FEEDBACK

In every feedback session, there must be a sender and a receiver. When receiving feedback, there are five considerations.

Seeing Each Feedback Session as a Learning Opportunity. Each time feedback is received, the feedback session should be seen as a learning opportunity because ideas are generated on how to improve performance. Whether the idea comes from the receiver or the sender, acting on suggestions usually leads to developing skills and knowledge.

Actively Listening to the Sender's Ideas. Active listening encourages the sender to present their feedback in a non-threatening environment. Active listening on the part of the receiver shows the sender that their feedback is important.

Asking for More Information if the Ideas are Not Understood. When the sender gives feedback and the ideas are not understood, the receiver should ask for more information. By asking questions for clarification, the receiver should be able to understand the sender's intent.

Being Honest About How the Feedback is Affecting One's Emotions. Receiving feedback can make the receiver feel uncomfortable. The receiver should be honest with the sender about how the feedback is affecting them. As the receiver, try not to get emotional or take the feedback personally.

Remaining Open-Minded About Future Learning Opportunities. It is important to be open-minded about future feedback. Senders may follow up on their feedback and may even provide even more feedback. The receiver should be aware of these future learning opportunities.

THIS PAGE INTENTIONALLY LEFT BLANK



**COMMON TRAINING
GOLD STAR
INSTRUCTIONAL GUIDE**



SECTION 5

EO M403.05 – PARTICIPATE IN A MENTORING RELATIONSHIP

Total Time:

60 min

PREPARATION

PRE-LESSON INSTRUCTIONS

Resources needed for the delivery of this lesson are listed in the lesson specification located in A-CR-CCP-704/PG-001, *Gold Star Qualification Standard and Plan*, Chapter 4. Specific uses for said resources are identified throughout the instructional guide within the TP for which they are required.

Review the lesson content and become familiar with the material prior to delivering the lesson.

Photocopy the scenario located at Attachment B for half the cadets in the class.

Photocopy the scenario located at Attachment C for half the cadets in the class.

PRE-LESSON ASSIGNMENT

Nil.

APPROACH

An interactive lecture was chosen for TPs 1 and 3 to review the mentoring relationship and to orient the cadets to the steps in a mentoring session.

A group discussion was chosen for TP 2 as it allows the cadets to interact with their peers and share knowledge, experiences, opinions and feeling about formal and informal mentoring.

A demonstration was chosen for TP 4 as it allows the instructor to explain and demonstrate a mentoring session.

A role-play was chosen for TP 5 as it provides the cadets an opportunity to view and then conduct a mentoring session under supervision.

INTRODUCTION

REVIEW

Nil.

OBJECTIVES

By the end of this lesson the cadet shall have participated in a mentoring relationship.

IMPORTANCE

It is important for cadets to participate in a mentoring relationship to assist in the development of their leadership abilities. The mentoring relationship provides an opportunity to expand leadership knowledge and skills of participants, enhances communication skills, resolves conflict and promotes constructive feedback, and should aid in leadership development.

Teaching Point 1**Review the mentoring relationship.**

Time: 5 min

Method: Interactive Lecture

THE MENTORING RELATIONSHIP

A mentoring relationship is an association between two people that focuses on self-development. One is the mentor; the other is the cadet being mentored. Both individuals are expected to learn from the relationship.

Recognizing the Purpose of a Mentoring Relationship

The purpose of the mentoring relationship is to share experiences between the mentor and the cadet being mentored, so the cadet being mentored is better prepared to move forward through the program with knowledge and confidence.

Identifying the Benefits of Participating in a Mentoring Relationship

The most significant benefit for the mentor is the realization that they have inspired the cadet to perform at higher levels than the cadet would have without a mentor. The basic benefit for a cadet being mentored is to show growth in skills and become a more independent and effective cadet.

Contributing to a Mentoring Match

Both the mentor and the cadet being mentored will have input with whom they are matched. The mentoring relationship is based on trust; it is necessary to ensure that a long-term and valuable connection can be made with the person chosen.

Being Open to New Things

For a mentoring relationship to be successful, both individuals must be willing to try new things. Expanding boundaries and increasing knowledge are foundations of the mentoring relationship. Being receptive to new ideas and experiences takes courage.

Being Responsive to Suggestions and Constructive Criticism

The mentor should use constructive criticism and attempt to provide feedback that will assist the cadet being mentored. The task of the cadet being mentored is to be receptive to recommendations being made.

Providing Feedback to the Mentor

It is important that the cadet being mentored provides feedback to the mentor. This feedback should be based on feelings, both positive and negative, and observations. If the cadet being mentored does not express feelings to the mentor about the relationship, then progress may be hindered.

Learning From the Mentor's Example

It is up to the mentor to set an example that the cadet being mentored would want to emulate. This example should be in all facets of the program. The cadet being mentored should learn not only from the mentor's successes but from the mentor's failures.

Participating in Mentoring Activities

The cadet being mentored must be prepared to participate in mentoring activities. These activities may include reflection, self-assessment, and discussions about successes, problems and failures. The mentor must also be prepared for each mentoring session. They need to have an agenda or plan of what will be discussed and ensure that the discussions stay on track.

Appreciating the Mentoring Relationship

An effective mentoring relationship must be respected by both people involved. Each person should have a high regard for the other in the relationship. Appreciating the other person for their effort, time and accomplishments can help ensure a long-lasting and mutually beneficial partnership.

CONFIRMATION OF TEACHING POINT 1

QUESTIONS:

- Q1. What is the basic benefit of a mentoring relationship for the cadet being mentored?
- Q2. What is the most significant benefit for the mentor to participate in a mentoring relationship?
- Q3. What are some examples of mentoring activities?

ANTICIPATED ANSWERS:

- A1. The basic benefit is that the cadet being mentored will grow in their skills and become a more independent cadet.
- A2. The most significant benefit for the mentor is the realization that they have inspired the cadet to perform at higher levels than they would have without a mentor.
- A3. Mentoring activities may include reflection, self-assessment, and discussions about successes, problems and failures.

Teaching Point 2

Discuss the difference between formal and informal mentoring.

Time: 5 min

Method: Group Discussion

BACKGROUND KNOWLEDGE



The purpose of the group discussion is to draw the following information from the group using the tips for answering / facilitating discussion and the suggested questions provided.

FORMAL MENTORING

Formal mentoring is a process where the mentor and cadet being mentored have regular meetings to discuss feedback. By the end of each meeting, expectations for the participants are agreed to. Usually, formal mentoring has specific goals such as the transfer of knowledge from the mentor to the cadet being mentored and developing the mentored cadet's leadership skills.

INFORMAL MENTORING

Informal mentoring is a practice where the mentor and the cadet being mentored discuss feedback. Informal mentoring is similar to teaching / coaching on the spot. There are no specific meetings during informal mentoring. The dialogue between the mentor and the cadet being mentored takes place as soon as possible after the activity or task.

GROUP DISCUSSION



TIPS FOR ANSWERING / FACILITATING DISCUSSION:

- Establish ground rules for discussion, eg, everyone should listen respectfully; don't interrupt; only one person speaks at a time; no one's ideas should be made fun of; you can disagree with ideas but not with the person; try to understand others as much as you hope they understand you; etc.
- Sit the group in a circle, making sure all cadets can be seen by everyone else.
- Ask questions that will provoke thought; in other words avoid questions with yes or no answers.
- Manage time by ensuring the cadets stay on topic.
- Listen and respond in a way that indicates you have heard and understood the cadet. This can be done by paraphrasing their ideas.
- Give the cadets time to respond to your questions.
- Ensure every cadet has an opportunity to participate. One option is to go around the group and have each cadet answer the question with a short answer. Cadets must also have the option to pass if they wish.
- Additional questions should be prepared ahead of time.

SUGGESTED QUESTIONS:

- Q1. Do you feel there is a difference between formal and informal mentoring? What is the difference?
- Q2. Which do you feel would be more appropriate for you? Why?
- Q3. Is formal or informal mentoring used more often within the Cadet Program? Give some examples of formal mentoring you have seen. Give some examples of informal mentoring you have seen.



Other questions and answers will develop throughout the group discussion. The group discussion should not be limited to only those suggested.



Reinforce those answers given and comments made during the group discussion, ensuring the teaching point has been covered.

CONFIRMATION OF TEACHING POINT 2

The cadets' participation in the group discussion will serve as the confirmation for this TP.

Teaching Point 3**Describe the steps of a formal mentoring session.**

Time: 10 min

Method: Interactive Lecture



When a cadet mentors another individual, the cadet contributes to the social competence and cognitive competence participant outcomes of the Cadet Program as listed in CATO 11-03, *Cadet Program Mandate*.

STEPS OF A FORMAL MENTORING SESSION

Mentoring is results-oriented. The mentor and the cadet being mentored must see results for the mentoring sessions to be considered successful.



Mentoring is based on three Ps: people, performance and positive outcomes.

A formal mentoring session has four steps:

1. **Getting acquainted.** The initial mentoring session must have an introduction where both the mentor and the cadet who is being mentored provide a few details about themselves. This step should allow both participants to establish a bond of trust.



Active listening is the most important skill of a good mentor. Active listening demands that the listener put aside any internal reactions and turn their attention to the speaker without judging what is being said.

2. **Setting goals.** During this step, goals are established. Work must be done to ensure the goals are specific, measurable, achievable, relevant, and timed. These goals should be in writing.
3. **Meeting goals and expectations.** During this step, the cadet being mentored must describe how they are going to meet the goals just set. In subsequent mentoring sessions, the cadet being mentored should be praised for achieving goals but may need to account for why the goals and expectations were not met.
4. **Concluding the mentoring session.** This conclusion should begin with the cadet being mentored giving a short explanation of new goals to be met and how the cadet plans to achieve them. The mentor should encourage the cadet being mentored and arrange the time and date for the next mentoring session.

CONFIRMATION OF TEACHING POINT 3**QUESTIONS:**

- Q1. What are the three Ps of mentoring?
- Q2. What is the most important skill for a mentor?
- Q3. What are the four steps of a formal mentoring session?

ANTICIPATED ANSWERS:

- A1. The three Ps of mentoring are people, performance and positive outcomes.
- A2. The most important skill for a mentor is active listening.
- A3. The four steps of a formal mentoring session are:
1. getting acquainted;
 2. setting goals;
 3. meeting goals and expectations; and
 4. concluding the mentoring session.

Teaching Point 4**Demonstrate and explain a mentoring session.**

Time: 10 min

Method: Demonstration



Present the following information before demonstrating a mentoring session.

Successful mentoring is based on the quality of the relationship between both participants. Trust is a basic ingredient to this relationship. The mentor must build and maintain trust by:

- keeping the mentoring relationship professional;
- keeping the conversation during the mentoring session in confidence; and
- using the ground rules for feedback during a mentoring session.

KEEPING THE MENTORING RELATIONSHIP PROFESSIONAL

Mentors must maintain a professional relationship with the cadet being mentored. The position of mentor can be rewarding but comes with inherent risks. Mentors need to remember that they are in a position of authority and must use their authority wisely. Mentors may deal with the cadets being mentored in a friendly manner; however, mentors cannot be their friends.

KEEPING THE CONVERSATION DURING THE MENTORING SESSION IN CONFIDENCE

The mentor and the cadet being mentored should keep the conversation between them in confidence. The dialogue should be kept private to avoid embarrassment by either participant.

USING THE GROUND RULES FOR FEEDBACK DURING A MENTORING SESSION

The mentor should use the ground rules for feedback during a mentoring session. It is important to provide feedback during a mentoring session correctly by:

- focusing on what is observed;
- focusing on behaviour;
- keeping it neutral;

- using it to inform;
- making it supportive; and
- keeping it simple.



This demonstration should be conducted as a role-play, where the instructor is the mentor and a cadet from the group is the cadet being mentored. Begin the demonstration by reading the scenario located at Attachment A to the cadets. Then begin introducing the remaining information in this TP while demonstrating a mentoring session.

One of the duties of a team leader is to mentor cadets. The format of a mentoring session is as follows:

1. The mentor and the cadet being mentored will sit across from each other and begin the session by introducing themselves.
2. The mentor and the cadet being mentored must set goals if goals have not been set.
3. If the goals have been set, the mentor will review the goals and expectations and ask the cadet being mentored how they are meeting those goals and expectations. The cadet being mentored is required to use self-reflection during this review stage.



This review stage should be done by asking various questions such as:

- How do you think things are going for you?
- Do you think you have areas that need improvement?
- In what areas would you like to see improvement?
- How do you think you can improve in those areas?

If the cadet being mentored has no idea on how to improve, then suggestions by the mentor may be given.

4. Before leaving the mentoring session, the cadet being mentored must be able to explain to the mentor their plan to keep old goals or set new goals. The mentor should encourage the cadet being mentored and arrange the time and date for the next mentoring session.



Planning to keep old goals or set new goals may be done by asking various questions such as:

- What are your long-term goals?
- What are you going to do to meet your long-term goals?

If the cadet being mentored has no idea on how to keep old goals or set new goals, then suggestions by the mentor may be given.

CONFIRMATION OF TEACHING POINT 4**QUESTIONS:**

- Q1. How does a mentor build trust with the cadet being mentored?
- Q2. Did the mentoring session go well? Why or why not?
- Q3. Give some examples of how the mentor used active listening skills?

ANTICIPATED ANSWERS:

- A1. The mentor builds trust by:
- keeping the mentoring relationship professional;
 - keeping the conversation during the mentoring session in confidence; and
 - using the ground rules for feedback during a mentoring session.
- A2. Answers will vary.
- A3. Answers will vary.

Teaching Point 5

Have the cadets role-play a mentoring session based on two given scenarios.

Time: 20 min

Method: Role-play



The scenarios for the role-play activity are located at Attachment B for Scenario 1 and Attachment C for Scenario 2.

ACTIVITY**OBJECTIVE**

The objective of this activity is to have the cadets role-play a mentoring session based on given scenarios.

RESOURCES

Scenarios located at Attachments B and C.

ACTIVITY LAYOUT

Nil.

ACTIVITY INSTRUCTIONS

1. Divide the cadets into pairs.
2. Distribute Attachment B to one cadet in each pair.
3. Distribute Attachment C to the other cadet in each pair.

4. Designate one cadet as the mentor and the other cadet as the cadet to be mentored in each pair.
5. Supervise while one cadet mentors another cadet by:
 - a. getting acquainted;
 - b. setting goals;
 - c. meeting goals and expectations; and
 - d. concluding the mentoring session.
6. After approximately 10 minutes have the cadets change roles.
7. Repeat Steps 4 and 5 for approximately 10 minutes.

SAFETY

Nil.

CONFIRMATION OF TEACHING POINT 5

The cadets' participation in the activity will serve as the confirmation for this TP.

END OF LESSON CONFIRMATION

The cadets' participation in the role-play will serve as the confirmation for this lesson.

CONCLUSION

HOMEWORK / READING / PRACTICE

Nil.

METHOD OF EVALUATION

Nil.

CLOSING STATEMENT

Being mentored and mentoring others is one way to enhance skills and knowledge of leadership. The mentoring relationship develops trust and trust is the foundation of leadership. The mentoring relationship provides an opportunity to expand leadership knowledge and skills, enhances communication skills, resolves conflict and promotes constructive feedback.

INSTRUCTOR NOTES / REMARKS

Cadets will have opportunities to participate in formal and informal mentoring relationships through the training year. A cadet in Gold Star is in a position to both mentor a subordinate cadet and be mentored by a more senior cadet and / or adult staff member.

REFERENCES

C0-258 ISBN 978-1-59869-450-5 Nigro, N. (2008). *The everything coaching and mentoring book*. (2nd ed.). Avon, MA: F+W Publications Company.

C0-324 Taylor, J. S. (2003). *Training new mentees: A manual for preparing youth in mentoring programs*. USA: The National Mentoring Center.

C0-405 ISBN 0-7879-6294-5 Rhodes, J. (2002). *New directions for youth development: A critical view of youth mentoring*. New York, NY: Jossey-Bass.

THIS PAGE INTENTIONALLY LEFT BLANK

SCENARIO FOR THE MENTORING DEMONSTRATION

The cadet being mentored is in the second year of training. The cadet is still having problems with wearing their uniform. The cadet being mentored is quite shy and does not like to ask for assistance. The cadet being mentored has set a goal of attending the Basic Leadership course for the summer.

THIS PAGE INTENTIONALLY LEFT BLANK

SCENARIO 1 FOR THE ROLE-PLAY ACTIVITY

The cadet being mentored is in their first year of training. They are having problems attending training nights each week. They have missed three of the last six training nights. The cadet being mentored is quite confident and when they attend training nights, their uniform and boots exceed inspection standard. The cadet being mentored has set a goal of attending the General Training course for the summer.

THIS PAGE INTENTIONALLY LEFT BLANK

SCENARIO 2 FOR THE ROLE-PLAY ACTIVITY

The cadet being mentored is in their second year of training. The cadet always talks while on parade and during classes and is disruptive to other members of the class. The cadet being mentored is sometimes defensive when correction is given to them. The cadet being mentored has set a goal of attending the Basic Fitness and Sports course for the summer.

THIS PAGE INTENTIONALLY LEFT BLANK



**COMMON TRAINING
GOLD STAR
INSTRUCTIONAL GUIDE**



SECTION 6

EO M403.06 – ACT AS A TEAM LEADER DURING A LEADERSHIP APPOINTMENT

Total Time:

30 min

PREPARATION

PRE-LESSON INSTRUCTIONS

Resources needed for the delivery of this lesson are listed in the lesson specification located in A-CR-CCP-704/PG-001, *Gold Star Qualification Standard and Plan*, Chapter 4. Specific uses for said resources are identified throughout the instructional guide within the TP for which they are required.

Review the lesson content and become familiar with the material prior to delivering the lesson.

Acquire the list of leadership appointments developed by the Training Officer.

Photocopy the Leadership Appointment Aide-Mémoire located at Attachment B for each cadet.

PRE-LESSON ASSIGNMENT

Nil.

APPROACH

An interactive lecture was chosen for this lesson to orient the cadets to the leadership appointment.

INTRODUCTION

REVIEW

Nil.

OBJECTIVES

By the end of this lesson the cadet shall be expected to act as a team leader during a leadership appointment.

IMPORTANCE

It is important for cadets to understand the concept of and steps involved in successfully completing a leadership appointment. All cadets will be assessed during a leadership appointment in Gold Star. When appointed in their given role, each cadet must know the expectations for successful completion. An effective team leader will merge together what has been learned throughout previous leadership training and practice, including problem solving and supervision.

Teaching Point 1**Describe a leadership assignment and a leadership appointment.**

Time: 5 min

Method: Interactive Lecture

LEADERSHIP ASSIGNMENT

A leadership assignment is a specific, short- or long-term practical leadership opportunity during which the team leader must apply their leadership skills. The team leader will have temporary team members either within or outside their peer group for whom they will be responsible. The team will accomplish a singular minor duty or task.



Leadership assignments in Gold Star may be the same as Silver Star. Each Gold Star cadet has already completed at least two leadership assignments during their third year of training.

LEADERSHIP APPOINTMENT

A leadership appointment is a specific long-term practical leadership opportunity that is more comprehensive in nature than a leadership assignment. The team leader must apply their leadership knowledge and skills and display the core leadership qualities of a cadet. The team leader will have an assigned, established team of cadets outside their peer group. The team will accomplish a singular major duty or task. These may be organizational appointments (eg, Platoon Warrant Officer, Platoon Commander, etc.), training appointments (eg, Star Level Non-commissioned Officer (NCO), etc.) or supplementary appointments (eg, Canteen Steward, Drill Team Commander, etc.). In generating leadership appointments, consideration must be given to the duration of the major duty or task and frequency of opportunities to exercise ongoing leadership to a specific team. The team leader is expected to meet with their team on a number of occasions over a period of time. Leadership appointments may be held by a single Gold Star cadet (eg, Drill Team Commander) or the Gold Star cadets may rotate through a position (eg, Canteen Steward). If a Gold Star cadet rotates through a leadership appointment, the appointment must be meaningful for the cadet and be of a duration that allows the cadet to meet the objectives of applying their leadership knowledge and skills and displaying the core leadership qualities of a cadet.

The team leader must supervise team members, communicate with team members to solve problems, strive to meet the needs and expectations of team members, motivate team members, and provide feedback to team members. The team leader must attempt to develop the skills and knowledge of their team members.

Direction for the leadership appointment shall be given by a superior, usually an activity leader or activity manager.



During Gold Star training, each cadet will be assessed, at least once, on a leadership assignment and once on a leadership appointment.

CONFIRMATION OF TEACHING POINT 1

QUESTIONS:

- Q1. What kind of team will the team leader have during a leadership appointment?
- Q2. How many leadership assignments will be assessed in Gold Star training?
- Q3. How many leadership appointments will be assessed in Gold Star training?

ANTICIPATED ANSWERS:

- A1. During a leadership appointment, the team leader will have an assigned, established team of cadets outside their peer group.
- A2. At least one leadership assignment will be assessed in Gold Star training.
- A3. One leadership appointment will be assessed in Gold Star training.

Teaching Point 2

Describe the leadership appointments that may be assigned at the corps.

Time: 5 min

Method: Interactive Lecture



Acquire the list of leadership appointments developed by the Training Officer before instructing this class. A list of possible Gold Star leadership assignments and appointments is located at Attachment A.

SAMPLE YEAR FOUR LEADERSHIP APPOINTMENTS

Organizational Appointments:

- Regimental Sergeant Major (RSM),
- Company Sergeant Major (CSM),
- Platoon Warrant Officer,
- Drum Major,
- Flag Party Commander,
- Training Assistant,
- Supply Assistant, and
- Administration Assistant.

Training Appointments:

- Star Level NCO,
- Drill and Ceremonial Instructor,
- Expedition Instructor,

- Fitness and Sports Instructor,
- Music Instructor, and
- Air Rifle Marksmanship Instructor.

Supplementary Appointments:

- Band Section Leader,
- Canteen Steward,
- Drill Team Commander,
- Marksmanship Team Captain,
- First Aid Team Captain,
- Biathlon Team Captain, and
- Sports Team Captain (only if there is a sufficient frequency and duration for practices, games and tournaments).

CONFIRMATION OF TEACHING POINT 2

QUESTIONS:

Q1. What leadership appointments are available at the corps?

ANTICIPATED ANSWERS:

A1. Answers will vary.

Teaching Point 3

Describe how to conduct the leadership appointment.

Time: 15 min

Method: Interactive Lecture



Each cadet has led a team through at least two leadership assignments; the steps for a leadership appointment are very similar.

When conducting the leadership appointment, the team leader should use the following steps:

1. prepare for the leadership appointment;
2. brief the team members at the onset and then throughout the leadership appointment;
3. carry out the tasks associated with the leadership appointment;
4. provide feedback to the team members throughout and at the completion of the leadership appointment;
and
5. meet with the activity manager throughout and at the completion of the leadership appointment to discuss the outcomes of the leadership appointment.

PREPARING FOR THE LEADERSHIP APPOINTMENT

Ensuring the Required Resources are Available

Make sure all the resources that will be necessary during the appointment are available. For example, if the appointment is to act as a flag party commander, the flags, poles, etc will need to be available, both for practice and performance opportunities.

Completing a Time Appreciation

Be aware of the end date of the appointment. If the appointment is comprised of stages or phases, the leader must determine how much time to allocate to each stage or phase. All members involved in the appointment must be aware of the current date and the end date of the appointment.

Making a Plan

Make a plan to be successful in the appointment by:

1. determining what stages or phases comprise the appointment;
2. determining tasks inherent within the appointment;
3. developing a process to accomplish all tasks; and
4. identifying and allocating resources.

BRIEFING TEAM MEMBERS DURING THE LEADERSHIP APPOINTMENT

Communicating the Overall Plan

Explain how the appointment will be carried out. All team members should know what is involved as the leader carries out the appointment. This may include identifying various stages and phases.

Communicating the Tasks Involved in the Leadership Appointment

Explain the tasks involved within the leadership appointment. Leadership appointments may be comprised of a series of tasks.

Assigning Tasks to Team Members as Applicable

Assign each team member the tasks that must be completed within the scope of the appointment. Every team member should be actively engaged in a meaningful activity.

Ensuring the Team Members Understand Their Tasks

Confirm the team members understand their tasks and ask the team members if they have any questions. The team leader should also ask a few questions to various team members to ensure comprehension. When team members are assigned specific tasks, it is important they understand what is expected of them.

CARRYING OUT THE TASKS ASSOCIATED WITH THE LEADERSHIP APPOINTMENT

Supervising Team Members

Throughout the leadership appointment, the team leader will have many occasions during which to supervise team members. The most important aspect of supervision is to ensure the tasks are being conducted safely. Supervision also allows the team leader to provide ongoing feedback to team members.

Ensuring the Tasks Within the Appointment are Progressing According to the Time Allotted

Do not wait until the last minute to ensure tasks are being completed. If tasks are not being completed as planned, whether too slow or too fast, the plan may need to be adjusted and feedback should be given. Careful monitoring of team members and the overall situation will ensure the team leader is leading successfully during the leadership appointment and the major duty or task will be accomplished.

Providing Feedback to the Team Members Throughout the Appointment

The team leader will provide feedback throughout the appointment. This feedback may be given to the team as a whole or it may be given to individual team members. Feedback should be provided such that it is frequent, accurate, specific, and timely. Successful supervision allows for ongoing feedback to be provided to the team. Feedback is necessary for the team members as it will allow them to develop as leaders also.

Modifying the Plan as Required

If the plan is not working, take time to modify it. If help is required from team members, ask for it. Modifying aspects of the plan partway through the appointment may benefit the outcome; however, always keep time limits and constraints in mind. If the plan is being revised, communicate the new plan to the team members and work with them to implement it.

PROVIDING FEEDBACK TO THE TEAM MEMBERS UPON CONCLUSION OF THE LEADERSHIP APPOINTMENT

It is important to give feedback to the team members upon conclusion of the leadership appointment. It is vital for the team leader to spend time focusing on how the team members worked together to achieve a common goal. When team members successfully complete a task, praise should be given. It is important to recognize dedication shown in seeing a task through to completion. Team leaders should try to recognize each team member for their contribution to the completion of a task.



It is important to know how the team members felt about their participation in the completion of the assignment.



The requirement for feedback upon the conclusion of the leadership appointment does not imply that feedback should not be provided at other opportunities over the course of the leadership appointment. The leader should select opportunities to provide feedback to the team at major milestones throughout the duration of the appointment. For example, a Platoon Warrant Officer may wish to provide feedback to the platoon on their dress and drill following each Commanding Officer's Parade.

The team leader should ask for feedback on the appointment from the team members. This can be done using general questions about the leadership appointment, such as:

- What was learned during the appointment?
- Was the goal met? What contributed to the success?
- How did everyone interact during the appointment?
- Were there behaviours that helped and / or hindered during the appointment?
- Were there any cadets who were not motivated to participate in the activity? How did this affect the morale of the remainder of the team?
- Were there leaders that emerged from within the team?

MEETING WITH THE ACTIVITY MANAGER TO DISCUSS THE OUTCOMES OF THE LEADERSHIP APPOINTMENT

Just as the team leader will provide ongoing feedback to the team members during the leadership appointment, the team leader will need periodic feedback from the activity manager to discuss and monitor progress of the major duty or task. Feedback from the activity manager should assist the team leader in improving performance. Once the leadership appointment is concluded, the team leader should meet with the activity leader for an overall debriefing. This feedback will aid the team leader during future leadership appointments.

CONFIRMATION OF TEACHING POINT 3

QUESTIONS:

- Q1. List the steps to conduct a leadership appointment.
- Q2. How does the team leader brief team members during a leadership appointment?
- Q3. After the leadership appointment is completed, why should the team leader meet with the activity manager to discuss the appointment?

ANTICIPATED ANSWERS:

- A1. The steps to conduct a leadership appointment are:
1. prepare for the leadership appointment;
 2. brief the team members at the onset and then throughout the leadership appointment;
 3. carry out the tasks associated with the leadership appointment;
 4. provide feedback to the team members throughout and at the completion of the leadership appointment; and
 5. meet with the activity manager throughout and at the completion of the leadership appointment to discuss the outcomes of the leadership appointment.
- A2. The team leader briefs team members during a leadership appointment by:
1. communicating the overall plan;
 2. communicating the tasks involved in the leadership appointment;
 3. assigning tasks to team members as applicable; and
 4. ensuring the team members understand their tasks.
- A3. After the leadership appointment is completed, the team leader should meet with the activity manager to discuss the appointment because feedback from the activity manager should give the team leader ideas to help improve performance.



Distribute the Leadership Appointment Aide-Mémoire located at Attachment B to each cadet.

END OF LESSON CONFIRMATION

QUESTIONS:

- Q1. What kind of team will the team leader have during a leadership appointment?
- Q2. What leadership appointments are available at the corps?
- Q3. List the steps to conduct a leadership appointment.

ANTICIPATED ANSWERS:

- A1. The team leader for a leadership appointment will have an assigned, established team of cadets outside their peer group.
- A2. Answers will vary.
- A3. The steps to conduct a leadership appointment are:
 - 1. prepare for the leadership appointment;
 - 2. brief the team members at the onset and then throughout the leadership appointment;
 - 3. carry out the tasks associated with the leadership appointment;
 - 4. provide feedback to the team members throughout and at the completion of the leadership appointment; and
 - 5. meet with the activity manager throughout and at the completion of the leadership appointment to discuss the outcomes of the leadership appointment.

CONCLUSION

HOMEWORK / READING / PRACTICE

Nil.

METHOD OF EVALUATION

This EO is assessed IAW A-CR-CCP-704/PG-001, *Gold Star Qualification Standard and Plan* Chapter 3, Annex B, 403 PC.

CLOSING STATEMENT

When appointed as team leader for a given major duty or task, the team leader is expected to follow a series of steps for successful conclusion of the appointment. Being able to motivate cadets, solve problems, supervise followers, give feedback and develop the skills and knowledge of team members during a leadership appointment is an expectation of all Gold Star cadets.

INSTRUCTOR NOTES / REMARKS

Acquire the list of leadership appointments developed by the Training Officer before instructing this lesson.

REFERENCES

- C0-114 ISBN 0-02-863656-2 Pell, A. R. (1999). *The complete idiot's guide to team building*. Indianapolis, IN: Alpha Books.
- C0-243 Clark, D. (2007). *After action reviews*. Retrieved February 21, 2008, from <http://www.nwlink.com/~donclark/leader/leadaar.html>
- C0-243 Clark, D. (2007). *Leadership & direction*. Retrieved February 21, 2008, from <http://www.nwlink.com/~donclark/leader/leaddir.html>
- C0-245 ISBN 1-58062-513-4 Adams, B. (2001). *The everything leadership book*. Avon, MA: Adams Media.
- C0-247 ISBN 0-14-024272-4 Rosen, R. H., & Brown, P. B. (1997). *Leading people*. New York, NY: Penguin Books.
- C0-248 ISBN 0-7894-4862-9 Heller, R. (1999). *Learning to lead*. New York, NY: DK Publishing, Inc.
- C0-253 ISBN 0-7894-8006-9 Bruce, A., & Langdon, K. (2001). *Do it now!* New York, NY: DK Publishing, Inc.
- C0-254 ISBN 0-7894-3244-7 Heller, R. (1998). *Communicate clearly*. New York, NY: DK Publishing, Inc.
- C0-255 ISBN 0-7645-5408-5 Brounstein, M. (2002). *Managing teams for dummies*. Indianapolis, IN: Wiley Publishing, Inc.
- C0-256 ISBN 0-7894-4863-7 Heller, R. (1999). *Achieving excellence*. New York, NY: DK Publishing, Inc.

THIS PAGE INTENTIONALLY LEFT BLANK

POSSIBLE YEAR FOUR LEADERSHIP APPOINTMENTS

Organizational Appointments:

- Regimental Sergeant Major (RSM),
- Company Sergeant Major (CSM),
- Platoon Warrant Officer,
- Drum Major,
- Flag Party Commander,
- Training Assistant,
- Supply Assistant, and
- Administration Assistant.

Training Appointments:

- Star Level Non-commissioned Officer (NCO),
- Drill and Ceremonial Instructor,
- Expedition Instructor,
- Fitness and Sports Instructor,
- Music Instructor, and
- Air Rifle Marksmanship Instructor.

Supplementary Appointments:

- Band Section Leader,
- Canteen Steward,
- Drill Team Commander,
- Marksmanship Team Captain,
- First Aid Team Captain,
- Biathlon Team Captain, and
- Sports Team Captain (only if there is a sufficient frequency and duration for practices, games and tournaments).

POSSIBLE YEAR FOUR LEADERSHIP ASSIGNMENTS



In Silver Star, cadets had the opportunity to lead a team during a leadership assignment that was short in duration and limited in scope. In Gold Star, these same assignments could be used to practice leadership skills. However, generally the scope of the assignment should be greater and the assignment could involve the supervision of Silver Star cadets as they undertake assignments that are more limited in scope.

Each category below could be conducted as one long-duration assignment or broken down into short-duration assignments. For example, a Silver Star assignment would be conducting a warm-up for 15 min prior to recreational sports, whereas a Gold Star assignment would be conducting a recreational sports assignment using a number of Silver Star cadets to assist in various requisite short-duration assignments as part of the overall assignment.

Recreational Marksmanship Assignment

- Set up a range for recreational marksmanship.
- Organize relays for recreational marksmanship.
- Control pellets and issue targets for recreational marksmanship.
- Conduct concurrent activities during recreational marksmanship.
- Tear down a range after recreational marksmanship.

Summer Biathlon Assignment

- Set up a range for a recreational summer biathlon activity.
- Conduct a warm-up activity prior to participating in a recreational summer biathlon activity.
- Control pellets for a recreational summer biathlon activity.
- Conduct a cool-down activity after participating in a recreational summer biathlon activity.
- Tear down a range after a recreational summer biathlon activity.

Recreational Sports Assignment

- Set up a recreational sports activity.
- Tear down a recreational sports activity.
- Organize a team for recreational sports.
- Conduct a warm-up prior to recreational sports.
- Conduct a concurrent activity during recreational sports.
- Conduct a cool-down after recreational sports.

Parade Assignment

- Set up chairs for a parade.
- Set up the dais area for a parade.

- Set up flags and parade markers for a parade.
- Tear down chairs after a parade.
- Tear down the dais area after a parade.
- Tear down flags and parade markers after a parade.

Weekly Cadet Night Duty NCO Assignment

- Set up classroom space.
- Rearrange classroom space.
- Tear down classroom space.
- Set up a canteen.
- Staff a canteen.
- Tear down a canteen.
- Set up a presentation area for a guest speaker.
- Tear down a presentation area for a guest speaker.
- Set up for an extracurricular activity.
- Conduct a concurrent activity.

Community Service Assignment

- Organize a team during a community service activity.
- Conduct concurrent activities during a community service activity.
- Complete a final garbage sweep.

Other Leadership Assignment Possibilities

- Ensure the safe loading and unloading of personnel on vehicles during transportation.
- Conduct uniform inspection of cadets.
- Collect and dispose of garbage after weekly parade.
- Collect, sort and dispose of recycling after weekly parade.
- Turn off lights and close windows after weekly parade.

FIELD TRAINING LEADERSHIP ASSIGNMENT(S)



In Silver Star, cadets had the opportunity to lead a team during a leadership assignment that was short in duration and limited in scope. In Gold Star, these same assignments could be used to practice leadership skills. However, generally the scope of the assignment should be greater and the assignment could involve the supervision of Silver Star cadets as they undertake assignments that are more limited in scope.

Each category below could be conducted as one long-duration assignment or broken down into short-duration assignments. For example, a Silver Star assignment would be to prepare a meal for a section, whereas a Gold Star assignment would be to supervise bivouac routine using a number of Silver Star cadets to assist in various requisite short-duration assignments as part of the overall assignment.

Prepare for an FTX

- Distribute personal equipment.
- Load team equipment and supplies for an FTX.

Occupy a Bivouac Site

- Create the bivouac layout plan.
- Unload equipment and supplies for an FTX.
- Construct a food hang.
- Set up the POL, first aid and fire points.
- Set up the female sleeping area.
- Set up the male sleeping area.
- Mark the components of the bivouac site.

Supervise Bivouac Site Routine

- Prepare a meal for a section.
- Clean up the site after a meal.
- Prepare the bivouac site for the night.
- Organize lights out for the female cadets.
- Organize lights out for the male cadets.

Tear Down the Bivouac Site

- Tear down the female sleeping area.
- Tear down the male sleeping area.
- Dismantle the POL, first aid and fire points.
- Dismantle the food hang and dispose of garbage.

- Load team equipment and supplies after an FTX.
- Erase signs of occupancy and complete a final garbage sweep.

After the FTX

- Unload equipment and supplies after an FTX.
- Collect personal equipment.

THIS PAGE INTENTIONALLY LEFT BLANK

LEADERSHIP APPOINTMENT AIDE-MÉMOIRE

TABLE OF CONTENTS

| | |
|---|-----|
| Leadership Assignment | B-2 |
| Leadership Appointment | B-2 |
| How to Conduct a Leadership Appointment | B-2 |
| Preparing for the Leadership Appointment | B-2 |
| Briefing Team Members During a Leadership Appointment | B-3 |
| Carrying Out the Tasks Associated With the Leadership Appointment | B-3 |
| Providing Feedback to the Team Upon Conclusion of the Leadership Appointment | B-4 |
| Meeting With the Activity Manager to Discuss the Outcomes of the Leadership Appointment | B-5 |
| 403 PC Assessment Rubric Leadership Assignment & Appointment | B-6 |

During Gold Star, each cadet will be assessed at least once on a leadership assignment and once on a leadership appointment.

LEADERSHIP ASSIGNMENT

A leadership assignment is a specific, short- or long-term practical leadership opportunity during which the team leader must apply their leadership skills. The team leader will have temporary team members either within or outside their peer group for whom they will be responsible. The team will accomplish a singular minor duty or task.

LEADERSHIP APPOINTMENT

A leadership appointment is a specific long-term practical leadership opportunity that is more comprehensive in nature than a leadership assignment. The team leader must apply their leadership knowledge and skills and display the core leadership qualities of a cadet. The team leader will have an assigned, established team of cadets outside their peer group. The team will accomplish a singular major duty or task. These may be organizational appointments (eg, Platoon Warrant Officer, Platoon Commander, etc.), training appointments (eg, Star Level Non-commissioned Officer (NCO), etc.) or supplementary appointments (eg, Canteen Steward, Drill Team Commander, etc.). In generating leadership appointments, consideration must be given to the duration of the major duty or task and frequency of opportunities to exercise ongoing leadership to a specific team. The team leader is expected to meet with their team on a number of occasions over a period of time. Leadership appointments may be held by a single Gold Star cadet (eg, Drill Team Commander) or the Gold Star cadets may rotate through a position (eg, Canteen Steward). If a Gold Star cadet rotates through a leadership appointment, the appointment must be meaningful for the cadet and be of a duration that allows the cadet to meet the objectives of applying their leadership knowledge and skills and displaying the core leadership qualities of a cadet.

The team leader must supervise team members, communicate with team members to solve problems, strive to meet the needs and expectations of team members, motivate team members, and provide feedback to team members. The team leader must attempt to develop the skills and knowledge of their team members.

Direction for the leadership appointment shall be given by a superior, usually an activity leader or activity manager.

HOW TO CONDUCT A LEADERSHIP APPOINTMENT

When conducting the leadership appointment, the team leader should use the following steps:

1. prepare for the leadership appointment;
2. brief the team members at the onset and then throughout the leadership appointment;
3. carry out the tasks associated with the leadership appointment;
4. provide feedback to the team members throughout and at the completion of the leadership appointment;
and
5. meet with the activity manager throughout and at the completion of the leadership appointment to discuss the outcomes of the leadership appointment.

PREPARING FOR THE LEADERSHIP APPOINTMENT

Ensuring the Required Resources are Available

Make sure all the resources that will be necessary during the appointment are available. For example, if the appointment is to act as a flag party commander, the flags, poles, etc will need to be available, both for practice and performance opportunities.

Completing a Time Appreciation

Be aware of the end date of the appointment. If the appointment is comprised of stages or phases, the leader must determine how much time to allocate to each stage or phase. All members involved in the appointment must be aware of the current date and the end date of the appointment.

Making a Plan

Make a plan to be successful in the appointment by:

1. determining what stages or phases comprise the appointment;
2. determining tasks inherent within the appointment;
3. developing a process to accomplish all tasks; and
4. identifying and allocating resources.

BRIEFING TEAM MEMBERS DURING THE LEADERSHIP APPOINTMENT

Communicating the Overall Plan

Explain how the appointment will be carried out. All team members should know what is involved as the leader carries out the appointment. This may include identifying various stages and phases.

Communicating the Tasks Involved in the Leadership Appointment

Explain the tasks involved within the leadership appointment. Leadership appointments may be comprised of a series of tasks.

Assigning Tasks to Team Members as Applicable

Assign each team member the tasks that must be completed within the scope of the appointment. Every team member should be actively engaged in a meaningful activity.

Ensuring the Team Members Understand Their Tasks

Confirm the team members understand their tasks and ask the team members if they have any questions. The team leader should also ask a few questions to various team members to ensure comprehension. When team members are assigned specific tasks, it is important they understand what is expected of them.

CARRYING OUT THE TASKS ASSOCIATED WITH THE LEADERSHIP APPOINTMENT

Supervising Team Members

Throughout the leadership appointment, the team leader will have many occasions during which to supervise team members. The most important aspect of supervision is to ensure the tasks are being conducted safely. Supervision also allows the team leader to provide ongoing feedback to team members.

Ensuring the Tasks Within the Appointment are Progressing According to the Time Allotted

Do not wait until the last minute to ensure tasks are being completed. If tasks are not being completed as planned, whether too slow or too fast, the plan may need to be adjusted and feedback should be given. Careful monitoring of team members and the overall situation will ensure the team leader is leading successfully during the leadership appointment and the major duty or task will be accomplished.

Providing Feedback to the Team Members Throughout the Appointment

The team leader will provide feedback throughout the appointment. This feedback may be given to the team as a whole or it may be given to individual team members. Feedback should be provided such that it is frequent, accurate, specific, and timely. Successful supervision allows for ongoing feedback to be provided to the team. Feedback is necessary for the team members as it will allow them to develop as leaders also.

Modifying the Plan as Required

If the plan is not working, take time to modify it. If help is required from team members, ask for it. Modifying aspects of the plan partway through the appointment may benefit the outcome; however, always keep time limits and constraints in mind. If the plan is being revised, communicate the new plan to the team members and work with them to implement it.

PROVIDING FEEDBACK TO THE TEAM MEMBERS UPON CONCLUSION OF THE LEADERSHIP APPOINTMENT

It is important to give feedback to the team members upon conclusion of the leadership appointment. It is vital for the team leader to spend time focusing on how the team members worked together to achieve a common goal. When team members successfully complete a task, praise should be given. It is important to recognize dedication shown in seeing a task through to completion. Team leaders should try to recognize each team member for their contribution to the completion of a task.

The team leader should ask for feedback on the appointment from the team members. This can be done using general questions about the leadership appointment, such as:

- What was learned during the appointment?
- Was the goal met? What contributed to the success?
- How did everyone interact during the appointment?
- Were there behaviours that helped and / or hindered during the appointment?
- Were there any cadets who were not motivated to participate in the activity? How did this affect the morale of the remainder of the team?
- Were there leaders that emerged from within the team?

MEETING WITH THE ACTIVITY MANAGER TO DISCUSS THE OUTCOMES OF THE LEADERSHIP APPOINTMENT

Just as the team leader will provide ongoing feedback to the team members during the leadership appointment, the team leader will need periodic feedback from the activity manager to discuss and monitor progress of the major duty or task. Feedback from the activity manager should assist the team leader in improving performance. Once the leadership appointment is concluded, the team leader should meet with the activity leader for an overall debriefing. This feedback will aid the team leader during future leadership appointments.

403 PC ASSESSMENT RUBRIC LEADERSHIP ASSIGNMENT

| | Incomplete (I) | Completed With Difficulty (D) | Completed Without Difficulty (C) | Exceeded the Standard (E) |
|---|--|---|--|--|
| Select a leadership approach. | Did not select an approach appropriate to the assignment. | Selected an approach and was challenged with balancing focus on the team members and the goal. | Selected an approach and strived to balance team members and the goal and simplicity and safety of the task. | Selected the most appropriate approach with a strong balance of team members and the goal and simplicity and safety of the task. |
| Communicate as a team leader. | Did not communicate with team members. | Communicated with team members occasionally. Team members needed clarification on many occasions. | Communicated with team members on many occasions. Team members needed few clarifications. | Communicated to the team throughout the leadership task. Team members did not need clarification. |
| Supervise team members. | Did not supervise team members. | Only supervised team members at the beginning and / or end of the leadership assignment. | Supervised throughout the leadership assignment making some corrections when necessary. | Supervised throughout the leadership assignment making corrections as necessary. |
| Solve problems. | Did not solve problems. | Attempted to solve some problems and selected inefficient problem solving methods. | Solved most problems as they arose and often selected the appropriate problem solving method. | Solved problems as they arose and selected the most appropriate problem solving method. |
| Motivate team members. | Did not motivate team members. | Only motivated periodically and without enthusiasm. | Motivated frequently and enthusiasm, with attention at times to both individuals and the team. | Motivated consistently and enthusiasm, addressing both individuals and the team. |
| Provide feedback to team members. | Did not provide feedback to team members. | Provided select feedback; was not always frequent, accurate, specific and / or timely. | Provided periodic feedback and was often frequent, accurate, specific and / or timely. | Provided consistent feedback and was regularly frequent, accurate, specific and / or timely. |
| Meet expectations of team members. | Made no effort to meet the needs and expectations of team members. | Made some efforts to meet the needs and expectations of team members but with limited results. | Made considerable efforts to meet the needs and expectations of team members with adequate results. | Made consistent efforts to meet the needs and expectations of team members with solid results. |
| Complete the leadership assignment. Perform self-assessment. | Did not complete the leadership assignment. | | Completed the leadership assignment. | |
| | Did not complete the self-assessment. | | Completed the self-assessment. | |

403 PC ASSESSMENT RUBRIC LEADERSHIP APPOINTMENT

| | Incomplete (I) | Completed With Difficulty (D) | Completed Without Difficulty (C) | Exceeded the Standard (E) |
|---|---|---|--|---|
| Select a leadership approach. | Did not select appropriate approach(es) throughout the appointment. | Selected an approach and was challenged with balancing focus on the team members and the goal throughout the appointment. | Selected approach(es) throughout the appointment and strived to balance team members and the goal and simplicity and safety of the task. | Selected the most appropriate approach(es) throughout the appointment with a strong balance of team members and the goal and simplicity and safety of the task. |
| Communicate as a team leader. | Did not communicate with team members. | Did not communicate with team members frequently enough. Team members needed clarification on many occasions. | Communicated with team members on many occasions. Team members needed few clarifications. | Communicated with team members consistently throughout the leadership appointment. Team members did not need clarification. |
| Supervise team members. | Did not supervise team members. | Did not successfully apply the principles of supervision; supervision was infrequent throughout the appointment. | Supervised throughout the leadership appointment, making some corrections when necessary. | Supervised consistently throughout the leadership appointment, making corrections as necessary. |
| Solve problems. | Did not solve problems. | Attempted to solve some problems and selected inefficient problem solving methods. | Solved most problems as they arose and often selected the appropriate problem solving method. | Solved problems as they arose and selected the most appropriate problem solving method. |
| Motivate team members. | Did not motivate team members. | Only motivated periodically and without enthusiasm. | Motivated frequently and enthusiasm, with attention at times to both individuals and the team. | Motivated consistently and enthusiasm, addressing both individuals and the team. |
| Provide feedback to team members. | Did not provide feedback to team members. | Provided select feedback; was not always frequent, accurate, specific and / or timely. | Provided periodic feedback and was often frequent, accurate, specific and / or timely. | Provided consistent feedback and was regularly frequent, accurate, specific and / or timely. |
| Meet expectations of team members. | Made no effort to meet the needs and expectations of team members. | Made some efforts throughout the appointment to meet the needs and expectations of team members but with limited results. | Made considerable efforts throughout the appointment to meet the needs and expectations of team members with adequate results. | Made consistent efforts throughout the appointment to meet the needs and expectations of team members with solid results. |
| Perform self-assessment. | Did not complete the self-assessment. | | Completed the self-assessment. | |



**COMMON TRAINING
GOLD STAR
INSTRUCTIONAL GUIDE**



SECTION 7

EO C403.01 – PARTICIPATE IN A LEADERSHIP SEMINAR

Total Time:

90 min

PREPARATION

PRE-LESSON INSTRUCTIONS

Resources needed for the delivery of this lesson are listed in the lesson specification located in A-CR-CCP-704/PG-001, *Gold Star Qualification Standard and Plan*, Chapter 4. Specific uses for said resources are identified throughout the instructional guide within the TP for which they are required.

Review the lesson content and become familiar with the material prior to delivering the lesson.

Review the information on seminars located at Attachment A.

Choose one of the four seminars. Prepare all materials for the seminar located at Attachments B–E.

PRE-LESSON ASSIGNMENT

Nil.

APPROACH

A seminar method was chosen for this lesson to stimulate active participation in a tutorial setting and to allow cadets to practice reflective thinking skills. Seminars assist cadets in developing new and imaginative interpretations of leadership topics being explored. Seminars are an interactive way to exchange information on techniques and approaches to the leadership subjects being researched and discussed.

INTRODUCTION

REVIEW

Nil.

OBJECTIVES

By the end of this lesson the cadets shall have participated in a leadership seminar.

IMPORTANCE

It is important for cadets to participate in a leadership seminar so they have an opportunity to further develop their leadership skills and knowledge. Leadership seminars allow cadets to discuss the best practices and explore leadership topics. This EO may be an introduction to the seminar format, which will be used throughout Master Cadet.

Teaching Point 1**Have the cadets participate in a leadership seminar.**

Time: 80 min

Method: Seminar



Have the cadets participate in a leadership seminar on one or more of the following topics:

- problem solving,
- time management,
- communication, and
- supervision.

ACTIVITY**OBJECTIVE**

The objective of this activity is to have the cadets participate in a leadership seminar.

RESOURCES

As per the selected topic (located at Attachments B–E).

ACTIVITY LAYOUT

Set up the classroom IAW the selected leadership seminar (located at Attachments B–E).

ACTIVITY INSTRUCTIONS

Follow the activity instructions IAW the selected leadership seminar (located at Attachments B–E).

SAFETY

Nil.

CONFIRMATION OF TEACHING POINT 1

The cadets' participation in a leadership seminar will serve as the confirmation of this TP.

END OF LESSON CONFIRMATION

The cadets' participation in a leadership seminar will serve as the confirmation of this lesson.

CONCLUSION**HOMEWORK / READING / PRACTICE**

Nil.

METHOD OF EVALUATION

Nil.

CLOSING STATEMENT

Participating in leadership seminars may assist you in further developing leadership skills and knowledge. One can never know all there is to know about leadership and seminars are an important tool to further explore each leadership topic. In addition, the seminar format used during this lesson will be used throughout Master Cadet.

INSTRUCTOR NOTES / REMARKS

This EO may be conducted as many as four times during Gold Star training.

REFERENCES

C0-022 ISBN 0-02864-207-4 Cole, Kris (2002). *The complete idiot's guide to clear communication*. Indianapolis, IN: Alpha Books.

C0-115 ISBN 0-7879-4059-3 van Linden, J. A., & Fertman, C. I. (1998). *Youth leadership*. San Francisco, CA: Jossey-Bass Inc., Publishers.

C0-425 Shurdington Scouts Resource. (1999). *NASA exercise: Survival on the moon*. Retrieved April 14, 2009, from <http://www.shurdington.org/Downloads/NASA%20Exercise.pdf>

C0-477 Mindtools: Essential skills for an excellent career. (2009). *Stepladder technique: Making better group decisions*. Retrieved April 14, 2009, from http://www.mindtools.com/pages/article/newTED_89.htm

C0-477 Mindtools: Essential skills for an excellent career. (2009). *Six thinking hats*. Retrieved April 14, 2009, from http://www.mindtools.com/pages/article/newTED_07.htm

C0-477 Mindtools: Essential skills for an excellent career. (2009). *Why do we procrastinate*. Retrieved March 30, 2009, from http://www.mindtools.com/pages/article/newHTE_96.htm

C0-477 Mindtools: Essential skills for an excellent career. (2009). *Preparing a to-do list*. Retrieved March 30, 2009, from http://www.mindtools.com/pages/article/newHTE_05.htm

C0-477 Mindtools: Essential skills for an excellent career. (2009). *Simple prioritization*. Retrieved March 30, 2009, from http://www.mindtools.com/pages/article/newHTE_92.htm

C0-479 PedagoNet: Brainteasers. (2009). *Problem solving: Do you have the answer?* Retrieved April 15, 2009, from <http://www.pedagonet.com/brain/brainers.html>

C0-480 Discovery Education. (2009). *Brain boosters*. Retrieved April 15, 2009, from <http://school.discoveryeducation.com/brainboosters/>

C0-481 Total success: A different type of training. (2009). *Time management: Manage yourself, not your time*. Retrieved March 31, 2009, from, <http://www.tsuccess.dircon.co.uk/timemanagementtips.htm>

C0-482 About.com: Small Business: Canada. (2009). *11 Time management tips*. Retrieved March 30, 2009, from, <http://sbinfocanada.about.com/cs/timemanagement/a/timemgttps.htm>

C0-483 College Board: Inspiring Minds (2009). *Time management tips for high school students*. Retrieved March 31, 2009, from, <http://www.collegeboard.com/student/plan,college-success/116.html>

C0-487 Department for Community Development, Government of Western Australia. (2008). *Supervision of children*. Retrieved April 1, 2009, from <http://www.pscwa.org.au/documents/DCDGUIOSHCFactSheetSupervisionofChildren.pdf>

SEMINAR INFORMATION

SEMINARS

Seminars are effective ways to communicate information on a particular topic to the rest of the group. Seminars are a tutorial arrangement involving an instructor and a small group. They are best used as a part of the developmental learning process. A seminar will be meaningful and realistic when it is focused on specific needs.

Seminars have many uses. They can be used to:

- pass on new information to a group;
- provide general guidance for a group working on a project;
- exchange information on techniques and approaches being explored by members of a group; and
- develop new and imaginative solutions to problems a group is encountering.

PREPARATION OF A GROUP

Prepare the group attending the activity so that they understand the importance of the seminar and are in the proper mindset. The instructor should:

1. prepare the problem, project, or topic of study in advance of the session;
2. introduce the lesson, identify the topic and its importance / relevance to the group, and describe how the seminar will proceed prior to the actual forum; and
3. assign research or study materials on a topic, prior to the seminar, if appropriate.

HOW TO CONDUCT A SEMINAR

During a seminar, employ strategies / approaches to explore new material, solve problems and exchange information such as:

- instructor presentation,
- learner presentation,
- group discussion,
- group brainstorming, or
- group work.

Follow the discussions and lead the group to draw conclusions regarding how to solve the problem or how they will use the new information.

Finally, close the discussion by highlighting the major conclusions and decisions made.

Workshops are similar and closely related to seminars. During a workshop, the group is presented with a problem or study subject and are required to produce possible solutions. A workshop can be used as an aspect of a seminar where the group concentrates on small amounts of material.

THIS PAGE INTENTIONALLY LEFT BLANK

LEADERSHIP SEMINAR PROBLEM SOLVING

Total Time:

90 min

PREPARATION

Photocopy Appendices 1, 4, 5 and 6 to Attachment B for each cadet.
Photocopy Appendices 2 and 3 to Attachment B (one per group).

The following components are conducted during this seminar:

| Number | Component | Time |
|--------|---|--------|
| 1 | Conduct an in-class activity where cadets solve the NASA moon survival scenario individually. | 10 min |
| 2 | Conduct an in-class activity where cadets solve the NASA moon survival scenario as a group. | 20 min |
| 3 | Conduct a group discussion on the NASA moon survival scenario. | 10 min |
| 4 | Explain how to use the stepladder problem-solving technique and the six thinking hats technique. | 10 min |
| 5 | Conduct an in-class activity where cadets solve a problem using the stepladder or six thinking hats techniques. | 10 min |
| 6 | Have cadets solve problems. | 15 min |
| 7 | Conduct a group discussion on the problem-solving seminar. | 5 min |

CONDUCT AN IN-CLASS ACTIVITY WHERE CADETS SOLVE THE NASA MOON SURVIVAL SCENARIO INDIVIDUALLY

ACTIVITY

Time: 10 min

OBJECTIVE

The objective of this activity is to have the cadets solve the NASA Survival on the Moon scenario individually.

RESOURCES

- NASA Survival on the Moon scenario and individual answer sheet located at Appendix 1 to Attachment B, and
- Pen / pencil.

ACTIVITY LAYOUT

Nil.

ACTIVITY INSTRUCTIONS

1. Distribute the NASA Survival on the Moon scenario and individual answer sheet to each cadet.
2. Have the cadets complete the NASA Survival on the Moon scenario.

SAFETY

Nil.

CONDUCT AN IN-CLASS ACTIVITY WHERE CADETS SOLVE THE NASA MOON SURVIVAL SCENARIO AS A GROUP

ACTIVITY

Time: 20 min

OBJECTIVE

The objective of this activity is to have cadets solve the NASA Survival on the Moon scenario as a group.

RESOURCES

- NASA Survival on the Moon scenario (distributed during previous activity),
- Completed NASA Survival on the Moon scenario and individual answer sheet from previous activity,
- NASA Survival on the Moon team answer sheet located at Appendix 2 to Attachment B, and
- Pen / pencil.

ACTIVITY LAYOUT

Nil.

ACTIVITY INSTRUCTIONS

1. Divide the cadets into groups.
2. Have one cadet read the scenario to the group.
3. Have the cadets complete the NASA Survival on the Moon scenario as a group using their previous answers as a guide.
4. Review the group's answers to the NASA Survival on the Moon scenario using Appendix 3 to Attachment B.
5. Have cadets score their answers as a group and then as individuals.

SAFETY

Nil.

CONDUCT A GROUP DISCUSSION ON THE NASA MOON SURVIVAL SCENARIO

Time: 10 min

BACKGROUND KNOWLEDGE



The purpose of the group discussion is to draw the following information from the group using the tips for answering / facilitating discussion and the suggested questions provided.

TRANSACTIONAL AND TRANSFORMATIONAL LEADERSHIP

Transactional leadership. Leaders exchange promises of rewards and benefits to team members so the team members will fulfill agreements with the leaders. This type of leadership is task-oriented. The leader sets the rules and procedures to complete a task and the team members comply with the rules and follow the procedures to accomplish the task.

Transactional Leadership:

- Values problem and solution identification.
- Makes decisions – even if everyone has not been heard – in order to move forward.
- Uses standards and principles as guides in decision making.
- Develops the self to be a better decision maker for the group.
- Gets things done.
- Recognizes the importance of the product.
- Takes charge (personal power).

Transformational leadership. Focuses on the process of being a leader by helping team members transform themselves from followers into leaders. Transformational leadership involves assisting team members to transcend their own self-interest for the good of the group, organization or society; to consider their long-term needs to develop themselves, rather than their immediate needs; and generally, to become more aware of what is really important.

Transformational Leadership:

- Values the participation and contribution of others.
- Takes all viewpoints and advice into account before making a decision.
- Considers individuals within their contexts and situations.
- Uses individuals to test decisions.
- Develops the self first to be a better contributor to the group.

- Learns from experiences to generalize to 'real life'.
- Recognizes the importance of the process.
- Shares leadership (group power).



Leadership within the cadet program has been designed to create transformational leadership. Transformational leadership enables the Cadet Program (CP) to meet its aim of developing in youth the attributes of good citizenship and leadership.

Transactional leadership focuses on the skills and tasks associated with leadership, such as public speaking, writing, delegating authority, leading meetings and making decisions. It is what people who are leaders do. Transformational leadership focuses on the process of leadership and what it means to be a leader. It is concerned with how individuals use their abilities to influence people. Think of the main difference between transactional and transformational leadership as doing leadership tasks versus being a leader.

GROUP DISCUSSION



TIPS FOR ANSWERING / FACILITATING DISCUSSION:

- Establish ground rules for discussion, eg, everyone should listen respectfully; don't interrupt; only one person speaks at a time; no one's ideas should be made fun of; you can disagree with ideas but not with the person; try to understand others as much as you hope they understand you; etc.
- Sit the group in a circle, making sure all cadets can be seen by everyone else.
- Ask questions that will provoke thought; in other words avoid questions with yes or no answers.
- Manage time by ensuring the cadets stay on topic.
- Listen and respond in a way that indicates you have heard and understood the cadet. This can be done by paraphrasing their ideas.
- Give the cadets time to respond to your questions.
- Ensure every cadet has an opportunity to participate. One option is to go around the group and have each cadet answer the question with a short answer. Cadets must also have the option to pass if they wish.
- Additional questions should be prepared ahead of time.

SUGGESTED QUESTIONS:

- Q1. Based on the two previous activities, which decisions were easier to make—individually or as a group?
- Q2. Which do you think was more effective?
- Q3. Give some examples of how decisions were made.
- Q4. Who influenced the decisions and how?
- Q5. Could better decisions have been made? How?

- Q6. How was conflict managed?
- Q7. How do you feel about the decisions?
- Q8. Were you satisfied with each decision? Why or why not?
- Q9. What would you change if you did this again?



Other questions and answers will develop throughout the group discussion. The group discussion should not be limited to only those suggested.



Reinforce those answers given and comments made during the group discussion, ensuring the teaching point has been covered.

EXPLAIN HOW TO USE THE STEPLADDER PROBLEM SOLVING TECHNIQUE AND THE SIX THINKING HATS TECHNIQUE

Time: 10 min

The Stepladder Technique

The stepladder technique is a step-by-step approach to help ensure that all members of the group are heard. The technique allows shy, quiet people to present their ideas to the group before other group members may influence them. This method allows everyone to hear many different viewpoints before reaching a final decision.

The stepladder technique steps:

1. present the problem or task;
2. form the core group of two members;
3. share ideas and discuss;
4. add the third member to the group;
5. share ideas and discuss;
6. add the fourth member to the group;
7. share ideas and discuss;
8. add additional members, one at a time, sharing ideas and discussing after each, until all members have been added; and
9. reach a final decision.

Many groups begin to lose effectiveness and the ability to make quality decisions if they have too many members. Keep the group small—four to six team members—to maximize effectiveness.

The Six Thinking Hats Technique

Six Thinking Hats is a good technique for looking at the effects of a decision from a number of different points of view. It allows necessary emotion and scepticism to be brought into what would otherwise be purely rational decisions. It opens up the opportunity for creativity within decision making. The Six Thinking Hats technique helps groups make better decisions by moving people outside their habitual ways of thinking. For example, persistently pessimistic cadets may be asked to be positive and creative.

Each Thinking Hat is a different style of thinking. These are:

White Hat. With this thinking hat, cadets must focus on the data available. They must look at the information they have and see what can be learned from it. They must look at gaps in the knowledge and either try to fill them or account for them. These cadets will analyze past trends and try to predict on the basis of what is known, what may happen.

Red Hat. With this thinking hat, cadets must look at the decision using intuition, gut reaction and emotion. They must try to think how other people may react emotionally, and try to understand the responses of others who do not know how the decision was made.

Black Hat. With this thinking hat, cadets must look at things pessimistically, cautiously and defensively. They try to see why ideas and approaches might not work. This may highlight the weak points in a plan or course of action. This allows the group to alter the approach or prepare contingency plans to counter problems that arise.

Yellow Hat. With this thinking hat, cadets must think only positively. They must keep an optimistic viewpoint that helps to see all the benefits and opportunities that arise from the decision or course of action. Yellow hat thinking helps to keep the group going when everything seems to be gloomy or difficult.

Green Hat. With this thinking hat, cadets must think creatively. They try to develop new, innovative and imaginative solutions to the problem or task. These cadets must think outside the box and not critique their own ideas before expressing them.

Blue Hat. With this thinking hat, cadets must focus on process control. This is the hat worn by people chairing the problem-solving session. When running into difficulties because ideas are running dry, they may direct cadets into a different coloured hat.

Using the Six Thinking Hats technique should improve the quality of decision-making. By "wearing" each of the thinking hats in turn, decisions are systematically explored.

CONDUCT AN IN-CLASS ACTIVITY WHERE CADETS SOLVE A PROBLEM SCENARIO USING THE STEPLADDER OR SIX THINKING HATS TECHNIQUE

ACTIVITY

Time: 10 min

OBJECTIVE

The objective of this activity is to have cadets solve a problem using the stepladder or Six Thinking Hats technique.

RESOURCES

Scenario located at Appendix 4 to Attachment B.

ACTIVITY LAYOUT

Nil.

ACTIVITY INSTRUCTIONS

1. Have the cadets select the stepladder technique or six thinking hats technique to solve the scenario.
2. Distribute the scenario to each cadet.
3. Have the cadets read the scenario.
4. Divide the cadets into groups of no more than six.
5. Have the cadets solve the scenario using the technique selected.

SAFETY

Nil.

HAVE CADETS SOLVE PROBLEMS

ACTIVITY

Time: 15 min

OBJECTIVE

The objective of this activity is to have the cadets solve problems.

RESOURCES

- Brainteasers and puzzles located at Appendix 5 to Attachment B, and
- Answer keys located at Appendix 6 to Attachment B.

ACTIVITY LAYOUT

Nil.

ACTIVITY INSTRUCTIONS



There are 10 problems to be solved. Cadets do not have to solve all the problems. Cadets should work on the problems in small groups.

1. Distribute Appendix 5 to Attachment B to each cadet.
2. Divide cadets into groups of no larger than three.
3. Have cadets solve the problems.
4. After 12 minutes, distribute answer keys located at Appendix 6 to Attachment B to each group.
5. Have the groups check their answers.

SAFETY

Nil.

CONDUCT A GROUP DISCUSSION ON THE PROBLEM-SOLVING SEMINAR

Time: 5 min



The purpose of the group discussion is to have cadets practice reflective thinking skills. Use the tips for answering / facilitating discussion and the suggested questions provided.

GROUP DISCUSSION



TIPS FOR ANSWERING / FACILITATING DISCUSSION:

- Establish ground rules for discussion, eg, everyone should listen respectfully; don't interrupt; only one person speaks at a time; no one's ideas should be made fun of; you can disagree with ideas but not with the person; try to understand others as much as you hope they understand you; etc.
- Sit the group in a circle, making sure all cadets can be seen by everyone else.
- Ask questions that will provoke thought; in other words avoid questions with yes or no answers.
- Manage time by ensuring the cadets stay on topic.
- Listen and respond in a way that indicates you have heard and understood the cadet. This can be done by paraphrasing their ideas.
- Give the cadets time to respond to your questions.
- Ensure every cadet has an opportunity to participate. One option is to go around the group and have each cadet answer the question with a short answer. Cadets must also have the option to pass if they wish.
- Additional questions should be prepared ahead of time.

SUGGESTED QUESTIONS:

- Q1. What have you learned during this seminar?
- Q2. Which activities did you enjoy during the seminar? Why?
- Q3. Will this information be useful to you?
- Q4. Where do you think you will use the information from this seminar?
- Q5. Now that you know the Stepladder and Six Thinking Hats Techniques, how have you changed your approach to solving a problem? How will this impact your decision-making?



Other questions and answers will develop throughout the group discussion. The group discussion should not be limited to only those suggested.



Reinforce those answers given and comments made during the group discussion, ensuring the teaching point has been covered.

THIS PAGE INTENTIONALLY LEFT BLANK



NASA Survival on the Moon

Scenario:

You are a member of a space crew originally scheduled to rendezvous with a mother ship on the lighted surface of the moon. However, due to mechanical difficulties, your ship was forced to land at a spot some 200 kilometres from the rendezvous point. During re-entry and landing, much of the equipment aboard was damaged and, since survival depends on reaching the mother ship, the most critical items available must be chosen for the 200-kilometre trip. The 15 items left intact and undamaged after landing are listed on the next page. Your task is to rank them in order of importance for your crew to help them reach the rendezvous point. Place the number 1 by the most important item, the number 2 by the second most important, and so on through number 15 for the least important.

NASA Survival on the Moon Individual Answer Sheet

Name _____

To be completed individually.

- _____ Box of Matches
- _____ Food Concentrate
- _____ 15 Metres of Nylon Rope
- _____ Parachute Silk
- _____ Portable Heating Unit
- _____ Two .45 Calibre Pistols
- _____ One Case of Dehydrated Milk
- _____ Two 50-Kilogram Tanks of Oxygen
- _____ Stellar Map
- _____ Self-Inflating Life Raft
- _____ Magnetic Compass
- _____ 20 Litres of Water
- _____ Signal Flares
- _____ First Aid Kit, Including Injection Needle
- _____ Solar-Powered FM Receiver-Transmitter

NASA Survival on the Moon Team Answer Sheet

TEAM NAME _____

To be completed as a group.

Team ranking NASA Ranking

_____ Box of Matches _____

_____ Food Concentrate _____

_____ 15 Metres of Nylon Rope _____

_____ Parachute Silk _____

_____ Portable Heating Unit _____

_____ Two .45 Calibre Pistols _____

_____ One Case of Dehydrated Milk _____

_____ Two 50-Kilogram Tanks of Oxygen _____

_____ Stellar Map _____

_____ Self-inflating Life Raft _____

_____ Magnetic Compass _____

_____ 20 Litres of water _____

_____ Signal Flares _____

_____ First Aid Kit, Including Injection Needle _____

_____ Solar-Powered FM Receiver-Transmitter _____

THIS PAGE INTENTIONALLY LEFT BLANK

Answers to the Survival on the Moon

| ITEM | NASA RANKING | NASA REASONING |
|--|--------------|---|
| Box of Matches | 15 | Virtually worthless—there is no oxygen on the moon to sustain combustion. |
| Food Concentrate | 4 | Efficient means of supplying energy requirements. |
| 15 Metres of Nylon Rope | 6 | Useful for scaling cliffs and for tying team members together while scaling cliffs. |
| Parachute Silk | 8 | Protection from the sun's rays. |
| Portable Heating Unit | 13 | Not needed unless on the dark side of the moon. |
| Two .45 Calibre Pistols | 11 | Possible means of self-propulsion. |
| One Case of Dehydrated Milk | 12 | Bulkier duplication of food concentrate. |
| Two 50-Kilogram Tanks of Oxygen | 1 | Most pressing survival need (weight is not a factor since gravity is one-sixth of the Earth's). |
| Stellar Map | 3 | Primary means of navigation—star patterns appear essentially identical on the moon as on Earth. |
| Self-Inflating Life Raft | 9 | Carbon dioxide bottle in the military raft may be used for propulsion. |
| Magnetic Compass | 14 | The magnetic field on the moon is not polarized, so it is worthless for navigation. |
| 20 Litres of Water | 2 | Needed for tremendous liquid loss on the light side of the moon. |
| Signal Flares | 10 | Use as distress signal when the mother ship is sighted. |
| First Aid Kit Including Injection Needle | 7 | Needles connected to vials of vitamins and medicines will fit in a special aperture in the NASA spacesuit. |
| Solar-Powered FM Receiver-Transmitter | 5 | For communications with the mother ship (FM radio requires line of sight transmission and can only be used over a short range). |

Scoring:

For each item, mark the number of points that your team score differs from the NASA ranking, then add up all the points. Disregard plus or minus differences. The lower the total, the better your score.

0–25 excellent

26–32 good

33–45 average

46–55 fair

56–70 poor—suggests use of Earth-bound logic.

71–112 very poor—you are one of the casualties of the space program!

STEPLADDER OR SIX THINKING HATS SCENARIO

Your corps has been given a large grant from the town / city of \$20 000. The corps staff want to spend the money on a tour. The entire corps can go on a fully paid tour of Washington, DC for seven days or the corps can send two cadets from each star level on a fully paid tour for one week to World War II sites in Europe. A decision must be made and the corps staff would like your input.

THIS PAGE INTENTIONALLY LEFT BLANK

PROBLEMS TO SOLVE

Problem #1

Four women, Louise, Lise, Carol and Lily, are seated at a table. They are chatting about their holidays.

They went to California, Texas, Florida and Arizona riding a lion, a tiger, a zebra, and a pony.

Question: What are the destinations and mode of transportation for each woman?

Hints:

- The woman riding the zebra did not smoke.
- Carol declared that she loved Miami.
- The woman riding the tiger had a cigarette with Lily.
- Louise said "Buy your pony a new saddle, Carol. I saw some during our trip to California?"
- The women riding the tiger mentioned that she has seen the Alamo in Texas.
- Lise was a chain smoker.

Problem #2

An army general wanted 10 soldiers to cross a river. There was no bridge and the soldiers could not swim. The general saw a row boat with two children on board. The boat could only hold two children or one soldier.

Question: How did the soldiers cross the river in the boat?

Problem #3

A crime has been committed. A life has been taken. The name, address and personal information are known to the police. However, this person shall never go to trial.

Question: Why?

Problem #4

A knight wanted to visit a princess. He had to arrive exactly at 1700 hours. If he travelled at 15 kilometres per hour, he would arrive one hour too early. If he travelled at 10 kilometres per hour, he would arrive one hour too late.

Questions:

At what time should he leave?

What distance will he travel?

At what speed will he travel?

Problem #5

A large ship is ignited on the high seas. All sailors, except the captain, leave aboard lifeboats. The captain dives and swims under the water for 90 metres. He hears an explosion. When he surfaces, he immediately hears another explosion. The captain rejoins a lifeboat and is pulled aboard by the sailors.

The captain mentions that he heard two explosions. The sailors state that they only heard one explosion. Both the captain and the sailors are telling the truth.

Question: How is this possible?

Problem #6

A girl, who was just learning to drive, went down a one-way street in the wrong direction, but did not break the law.

Question: How is this possible?

Problem #7

After school on Monday, Jody found this note in code taped to her locker.

Yg ctg jcxkpi c uwtrtkug rctva hqt Ou. Dtqyp.

At first, she couldn't figure it out. Then someone whispered in her ear, "M stands for K." Just that one clue helped Jody crack the code.

Question: What does the note say? How did you crack the code?

Problem #8

One man, one woman and some kids are out boating. There were three boats—one red, one blue, and one yellow—out on the river that morning. The boats were three different types: a yacht, a sailboat and a canoe. The people on the boats were from three different countries: France, Sweden and Italy.

Questions: What colour is each boat? What type is each boat? Who is on each boat? Which country do the people come from?

Hints:

- The woman is not in a yellow boat and is not from France.
- The red boat is not from Italy.
- The kids are in a blue boat, but they are not from Italy or Sweden.
- The man and his dog are on a yacht with an Italian flag.
- The sailboat is from France, while the canoe is red.

Problem #9

Amir tied two sacks of salt to the back of his donkey and headed for the market to sell the salt. On the way, Amir and the donkey passed a stream. The donkey jumped in to cool himself. As a result, much of the salt dissolved into the water, ruining the salt for Amir but improving matters for the donkey because his load became much lighter. Amir tried to get to the market on the following days, but the donkey always ruined the salt. Finally, Amir decided to teach the donkey a lesson. He once again set out with the donkey and the two sacks.

Question: What did Amir do differently this time so that after that day the donkey stopped taking a swim?

Problem #10

Train A and train B are crossing the country, from coast to coast, over 5 000 kilometres of railroad track. Train A is going from east to west at 80 kilometres per hour, and Train B is going from west to east at 90 kilometres per hour.

Question: Which train will be closer to the west coast when they meet?

Hint: You don't have to do any math to get the answer.

THIS PAGE INTENTIONALLY LEFT BLANK

ANSWER KEY TO PROBLEMS

Problem #1

Answer:

Louise - California - zebra

Lise - Texas - tiger

Carol - Florida - pony

Lily- Arizona - lion

Problem #2

Answer:

Start with two children crossing. One child gets out of the boat, the other child returns in the boat. The second child gets out of the boat and the soldier crosses. The first soldier gets out of the boat, and the first child gets in the boat and returns. Repeat the process until all the soldiers, the general and the children have crossed the river.

Problem #3

Answer:

No person shall go to trial because the crime was a suicide.

Problem #4

Answer:

He should leave at 1200 hours. He will travel 60 kilometres. He will travel 12 kilometres per hour.

Problem #5

Answer:

It is true because sound travels more rapidly under water than on the surface.

Problem #6

Answer:

She was walking.

Problem #7

Answer:

The message reads, "We are having a surprise party for Ms. Brown." M stands for K tells you that the alphabet has shifted two letters.

STRATEGY: Write the alphabet in a row, with a second alphabet below it, starting with a below c. When you get to x in the second row, go to the a in the top row and write y below it and z below b.

Problem #8

Answer:

Yellow - yacht - man - Italy

Red - canoe - woman - Sweden

Blue - sailboat - kids - France

Problem #9

Answer:

Amir loaded the sacks not with salt but with sand. When the donkey jumped in the stream and got the sacks wet, they became much heavier.

Problem #10

When the trains meet, they will be at exactly the same point. Therefore, they will each be the same distance from the west coast.

LEADERSHIP SEMINAR TIME MANAGEMENT

Total Time: 90 min

PREPARATION

Photocopy Appendix 1 to Attachment C.

The following components are conducted during this seminar:

| Number | Component | Time |
|--------|--|--------|
| 1 | Explain that time management is a myth. | 5 min |
| 2 | Conduct an activity where cadets brainstorm a list of time stealers. | 10 min |
| 3 | Conduct an activity where cadets reflect on and create a list of activities where they spend the most time and the least time. | 10 min |
| 4 | Explain procrastination. | 10 min |
| 5 | Conduct an activity where cadets brainstorm time-management tips. | 10 min |
| 6 | Explain time-management tips for teens. | 5 min |
| 7 | Explain preparing to-do lists. | 5 min |
| 8 | Conduct a group discussion on how technology may aid in time management. | 5 min |
| 9 | Conduct an in-class activity where cadets create a to-do list based on a scenario. | 15 min |
| 10 | Conduct a group discussion on the time-management seminar. | 5 min |

EXPLAIN THAT TIME MANAGEMENT IS A MYTH

Time: 5 min

TIME MANAGEMENT IS A MYTH

There are only 24 hours in every day. Time never changes. Time management does not refer to managing time; it refers to managing ourselves. Organizing and managing workload and free time is what is meant by time management. It means what one does with the time one has.

CONDUCT AN ACTIVITY WHERE CADETS BRAINSTORM A LIST OF TIME STEALERS

BACKGROUND KNOWLEDGE

Time stealers include:

- interruptions (telephones, visitors, etc),
- procrastination and indecisions,
- dealing with minor tasks that should have be delegated,
- acting with incomplete information,
- lack of planning,

- stress and fatigue,
- inability to say "No", and
- personal disorganization.

ACTIVITY

Time: 10 min

OBJECTIVE

The objective of this activity is to have the cadets brainstorm a list of time stealers.

RESOURCES

- Two flip charts, and
- Two markers.

ACTIVITY LAYOUT

Nil.

ACTIVITY INSTRUCTIONS

1. Divide the cadets into two groups.
2. Give each group a flip chart and marker.
3. Have each group brainstorm and record on the flip chart a list of time stealers.
4. Have one member from each group share their list with the class.

SAFETY

Nil.

CONDUCT AN ACTIVITY WHERE CADETS REFLECT ON AND CREATE A LIST OF ACTIVITIES WHERE THEY SPEND THE MOST TIME AND THE LEAST TIME

Time: 10 min

OBJECTIVE

The objective of this activity is to have the cadets reflect on and create a list of activities where they spend the most time and the least time.

RESOURCES

- Paper, and
- Pen / pencil.

ACTIVITY LAYOUT

Nil.

ACTIVITY INSTRUCTIONS

1. Distribute paper and pen / pencil to each cadet.
2. Explain to the cadets that they are to reflect and create a list of activities where they spend the most time and the least time.



Do not force cadets to share their list if they do not wish.

3. After six minutes have the cadets present their list to the class.

SAFETY

Nil.

EXPLAIN PROCRASTINATION

Time: 10 min

WHY DO CADETS PROCRASTINATE?

Procrastination is putting things off that should be focused on right now. Usually, things are put off in favour of doing something that is more enjoyable or that is easier to accomplish. Procrastinators work as many hours in a day as other cadets but procrastinators invest their time in the wrong tasks.

Sometimes this is simply because cadets do not understand the difference between urgent tasks (time-sensitive) and important tasks (significant), and they jump straight into urgent tasks that are not actually important. They may think they are doing the right thing because they are reacting quickly or they may simply be driven by the person whose demands are the loudest.

Important. Of great effect or consequence; significant.

Urgent. Demanding or requiring immediate action or attention.

Causes of Procrastination

Another common cause of procrastination is that cadets feel overwhelmed by the task. Cadets may not know where to begin, or they may doubt they have the skills or resources to complete the task. Cadets may seek comfort in doing tasks that they know they are capable of completing.

Other Causes of Procrastination

Other causes of procrastination include:

- waiting for the "right" mood or the "right" time to tackle the important tasks;
- a fear of failure or success;
- underdeveloped decision-making skills;

- poor organizational skills; and
- perfectionism (cadets think they do not have the right skills or resources to accomplish the task perfectly so they do not begin at all).



Ask cadets to name some tasks that they might procrastinate on rather than getting started.

HOW TO OVERCOME PROCRASTINATION

Whatever the reason behind procrastination, it must be acknowledged, dealt with and controlled.

1. **Recognize that you are procrastinating.** Be honest with yourself; you probably know when you are procrastinating.
2. **Work out why you are procrastinating.** Why you procrastinate can depend on both you and the task. Understanding the reason for procrastination for each situation will help you select the best approach to overcoming your reluctance to get going.
3. **Get over it.** If you are putting something off because you just do not want to do it, and you can not delegate the work, you need to find a way to motivate yourself. The following approaches may be helpful:
 - make up your own rewards;
 - ask someone to check up on you; or
 - identify unpleasant consequences of not doing the task.

If you are putting off starting a project because you find it overwhelming, you may need a different approach. Here are some tips:

- break the project into smaller, or manageable tasks;
- start with some quick small tasks, even if these are not the logical place to start. This will help you feel like you are achieving results.

CONDUCT AN ACTIVITY WHERE CADETS BRAINSTORM TIME-MANAGEMENT TIPS

ACTIVITY

Time: 10 min

OBJECTIVE

The objective of this activity is to have the cadets brainstorm time-management tips.

RESOURCES

- Flipchart, and
- Marker.

ACTIVITY LAYOUT

Nil.

ACTIVITY INSTRUCTIONS

1. Divide the cadets into groups of no more than six.
2. Have the cadets select a recorder for the brainstorming session.
3. Explain to cadets that they are to create a list of time-management tips for other cadets.
4. Have the selected cadet record the suggestions.
5. Have each group share their tips with the rest of the class.

SAFETY

Nil.

EXPLAIN TIME-MANAGEMENT TIPS FOR TEENS

Time: 5 min

If it seems like there is never enough time in the day to get everything done, use the following tips to organize and take control of the situation:

- make a to-do list;
- use spare minutes wisely;
- it's okay to say "No";
- find the right and best time for work;
- get a good night's sleep;
- communicate the schedule to others;
- create a time budget and plan accordingly;
- don't waste time agonizing; get on with it; and
- set realistic goals.

EXPLAIN HOW TO PREPARE TO-DO LISTS

Time: 5 min

A to-do list is a prioritized list of tasks that need to be completed. It lists what must be done with the important tasks at the top of the list and the least important tasks at the bottom of the list.

Keeping to-do lists ensures that all tasks that need to be accomplished are captured in one place. This is essential in order not to forget things. By prioritizing work, a plan is created. This ensures that tasks that need immediate attention are completed first.

Preparing a To-do List

Begin by writing down all of the tasks that need to be completed. If the tasks are large, break them into parts. All tasks on the list should take no more than 1–2 hours to complete.

How to Prioritize the To-do List

The next step in creating a useful to-do list is to prioritize each task on the to-do list. There are many ways to prioritize but usually priorities are based on time constraints and / or the benefit of the accomplishment of the task. For example, a priority based on time constraints could be if you have to take a sibling to a ball game at six in the evening, and the clock reads 5:30 pm, that task will move to a very high priority. An example based on a benefit of the task could be if you wish to buy a newer car, you cannot miss shifts at work. Shifts at work will have a very high priority.

Allocate priorities for each task from A (very important or very urgent) to F (unimportant or not urgent at all). If too many tasks have a high priority, go through the to-do list again and demote the less important tasks. Once this has been accomplished, rewrite the list in order of priority.

CONDUCT A GROUP DISCUSSION ON HOW TECHNOLOGY MAY AID IN TIME MANAGEMENT

Time: 5 min

GROUP DISCUSSION



TIPS FOR ANSWERING / FACILITATING DISCUSSION:

- Establish ground rules for discussion, eg, everyone should listen respectfully; don't interrupt; only one person speaks at a time; no one's ideas should be made fun of; you can disagree with ideas but not with the person; try to understand others as much as you hope they understand you; etc.
- Sit the group in a circle, making sure all cadets can be seen by everyone else.
- Ask questions that will provoke thought; in other words avoid questions with yes or no answers.
- Manage time by ensuring the cadets stay on topic.
- Listen and respond in a way that indicates you have heard and understood the cadet. This can be done by paraphrasing their ideas.
- Give the cadets time to respond to your questions.
- Ensure every cadet has an opportunity to participate. One option is to go around the group and have each cadet answer the question with a short answer. Cadets must also have the option to pass if they wish.
- Additional questions should be prepared ahead of time.

SUGGESTED QUESTIONS:

- Q1. What types of technology may help in time-management?
- Q2. How can those technologies help?
- Q3. Do you use technologies to help keep you on track and organized?
- Q4. How do they help you?



Other questions and answers will develop throughout the group discussion. The group discussion should not be limited to only those suggested.



Reinforce those answers given and comments made during the group discussion, ensuring the teaching point has been covered.

**CONDUCT AN IN-CLASS ACTIVITY WHERE CADETS
CREATE A TO-DO LIST BASED ON A SCENARIO**

ACTIVITY

Time: 15 min

OBJECTIVE

The objective of this activity is to have the cadets create a to-do list based on a scenario.

RESOURCES

- Scenario located at Appendix 1 to Attachment C,
- Paper, and
- Pen / pencil.

ACTIVITY LAYOUT

Nil.

ACTIVITY INSTRUCTIONS

1. Distribute the scenario to each cadet.
2. Have cadets create a to-do list based on the scenario.
3. Have cadets present their to-do list to the group, and explain why they prioritized their list the way they did.

SAFETY

Nil.

CONDUCT A GROUP DISCUSSION ON THE TIME-MANAGEMENT SEMINAR

Time: 5 min

BACKGROUND KNOWLEDGE



The purpose of the group discussion is to have cadets practice reflective thinking skills. Use the tips for answering / facilitating discussion and the suggested questions provided.

GROUP DISCUSSION



TIPS FOR ANSWERING / FACILITATING DISCUSSION:

- Establish ground rules for discussion, eg, everyone should listen respectfully; don't interrupt; only one person speaks at a time; no one's ideas should be made fun of; you can disagree with ideas but not with the person; try to understand others as much as you hope they understand you; etc.
- Sit the group in a circle, making sure all cadets can be seen by everyone else.
- Ask questions that will provoke thought; in other words avoid questions with yes or no answers.
- Manage time by ensuring the cadets stay on topic.
- Listen and respond in a way that indicates you have heard and understood the cadet. This can be done by paraphrasing their ideas.
- Give the cadets time to respond to your questions.
- Ensure every cadet has an opportunity to participate. One option is to go around the group and have each cadet answer the question with a short answer. Cadets must also have the option to pass if they wish.
- Additional questions should be prepared ahead of time.

SUGGESTED QUESTIONS:

- Q1. What have you learned during this seminar?
- Q2. Which activities did you enjoy during the seminar? Why?
- Q3. Will this information be useful to you?
- Q4. Where do you think you will use the information from this seminar?



Other questions and answers will develop throughout the group discussion. The group discussion should not be limited to only those suggested.



Reinforce those answers given and comments made during the group discussion, ensuring the teaching point has been covered.

THIS PAGE INTENTIONALLY LEFT BLANK

SCENARIO FOR CREATING A TO-DO LIST

It is Friday morning at 8:00 am. All tasks must be completed by 8:00 am on Monday.

The following tasks must be accomplished. Create a to-do list in priority order.

- Go to school from 9:00 am to 3:00 pm on Friday.
- Work from 6:00 pm to 9:00 pm on Saturday night.
- Pick up your sister from ballet on Sunday at 1:00 pm.
- Clean your room.
- Polish your boots.
- Take out the garbage.
- Make a lesson plan for cadets on Monday night.
- Go to a movie.
- Hang out with your friends.
- Cut the lawn.
- Do your homework which includes a 1 000 word essay, four math problems, and reading two chapters of your history text.
- Play basketball on Saturday.
- Update your resume.
- Have supper at your grandparents on Sunday.
- Study for final exams.
- Eat meals.
- Sleep at least eight hours a night.
- Work out with weights.

THIS PAGE INTENTIONALLY LEFT BLANK

LEADERSHIP SEMINAR COMMUNICATIONS

Total Time:

90 min

PREPARATION

Photocopy Appendices 1 and 3 to Attachment D for each cadet.
Photocopy Appendices 2 to Attachment D.

The following components are conducted during this seminar:

| Number | Component | Time |
|--------|--|--------|
| 1 | Have cadets participate in a communication exercise. | 15 min |
| 2 | Conduct a group discussion on the communications exercise. | 5 min |
| 3 | Demonstrate and explain how to build rapport using a role-play scenario. | 20 min |
| 4 | Explain reading body language. | 15 min |
| 5 | Conduct an activity where cadets read negative and positive body language. | 20 min |
| 6 | Conduct a group discussion on the communications seminar. | 5 min |

HAVE CADETS PARTICIPATE IN A COMMUNICATION EXERCISE

ACTIVITY

Time: 15 min

OBJECTIVE

The objective of this activity is to have the cadets give and receive instructions without non-verbal cues.

RESOURCES

- Figures located at Appendix 1 to Attachment D,
- Paper, and
- Pens / pencil.

ACTIVITY LAYOUT

Nil.

ACTIVITY INSTRUCTIONS

1. Have the cadets find a partner.
2. Have the cadets sit back-to-back.
3. Distribute paper and pen / pencil to each cadet.
4. Distribute picture A to one cadet and picture B to the other cadet.

5. Have the first cadet describe and give instructions to the other cadet to reproduce picture A. The cadet receiving instructions cannot ask for clarification; they may only ask for repetition.
6. Allow the first cadet seven minutes to complete the instructions.
7. Have the other cadet describe and give instructions to the first cadet to reproduce picture B. The cadet receiving instructions cannot ask for clarification; they may only ask for repetition.
8. Allow the second cadet seven minutes to complete the instructions.
9. Have each cadet exchange pictures.

SAFETY

Nil.

CONDUCT A GROUP DISCUSSION ON THE COMMUNICATIONS EXERCISE

Time: 5 min



The purpose of the group discussion is to have cadets practice reflective thinking skills. Use the tips for answering / facilitating discussion and the suggested questions provided.

GROUP DISCUSSION



TIPS FOR ANSWERING / FACILITATING DISCUSSION:

- Establish ground rules for discussion, eg, everyone should listen respectfully; don't interrupt; only one person speaks at a time; no one's ideas should be made fun of; you can disagree with ideas but not with the person; try to understand others as much as you hope they understand you; etc.
- Sit the group in a circle, making sure all cadets can be seen by everyone else.
- Ask questions that will provoke thought; in other words avoid questions with yes or no answers.
- Manage time by ensuring the cadets stay on topic.
- Listen and respond in a way that indicates you have heard and understood the cadet. This can be done by paraphrasing their ideas.
- Give the cadets time to respond to your questions.
- Ensure every cadet has an opportunity to participate. One option is to go around the group and have each cadet answer the question with a short answer. Cadets must also have the option to pass if they wish.
- Additional questions should be prepared ahead of time.

SUGGESTED QUESTIONS:

- Q1. How did you feel about giving instructions? Were your instructions to the point?
- Q2. How did you feel about receiving instructions? Could the instructions you were given be more clear?
- Q3. Which was more difficult, giving or receiving instruction? Why?
- Q4. Would this exercise have been easier if you could see your partner? Why or why not?



Other questions and answers will develop throughout the group discussion. The group discussion should not be limited to only those suggested.



Reinforce those answers given and comments made during the group discussion, ensuring the teaching point has been covered.

DEMONSTRATE AND EXPLAIN HOW TO BUILD RAPPORT USING A ROLE-PLAY SCENARIO

BACKGROUND KNOWLEDGE

BUILDING RAPPORT

Rapport builds naturally over time with cadets who are trusted and who are believable. The process of building rapport can be sped up by matching and mirroring the other cadet's verbal and non-verbal communications.

Matching Body Language

Matching body language can take several forms. One may match the other cadet's whole body position, the position of the upper or lower half of their body, or the angle of their head and shoulder. Matching may also be done by using the cadet's same type and rate of movement and gestures. One may match things exactly or partially.

Matching Voice

Matching may also be done using the other cadet's voice. One may match their volume, speed, pitch, rhythm, inflections and pauses. One may match their type of language and vocabulary and speech patterns.

Matching Energy

One may match the other cadet's energy level also. One may match how rapidly they breathe and whether they breathe using shallow or deep breaths.

Mirroring

Instead of matching the cadet's body movements, one may mirror them. When the cadet crosses their right leg over their left, one may cross their left leg over their right.

The idea of building rapport through matching and mirroring is not to copy blindly every movement a cadet makes or each body position they sit in. Building rapport is something that is done "with" a cadet, not "to" a cadet.

ACTIVITY

Time: 20 min



When conducting the role-play, take the part of a mentor. Ensure when acting as the mentor during the role-play to use matching and mirroring techniques.

OBJECTIVE

The objective of this activity is to have the cadets see communications that build rapport using a role-play scenario.

RESOURCES

- Role-play scenario located at Appendix 2 to Attachment D,
- Paper,
- Pen/ pencil.

ACTIVITY LAYOUT

Nil.

ACTIVITY INSTRUCTIONS

1. Distribute paper and a pen / pencil to each cadet.
2. Ask cadets to volunteer to take part in the role-play.
3. Select one cadet to take part in the role-play.
4. Distribute the role-play scenario to the selected cadet.
5. Ask all other cadets to write down their observations about the role-play scenario.
6. Conduct the role-play scenario with the selected cadet.
7. After eight minutes, conclude the role-play scenario.
8. Have the rest of the cadets share their observations about the scenario. Ensure the cadets give examples for their observations.
9. Describe the matching and mirroring techniques that were used during the role-play scenario.

SAFETY

Nil.

EXPLAIN READING BODY LANGUAGE

Time: 15 min

Body language reveals a cadet's true thoughts. It may forewarn problems, such as lack of understanding, disagreement or conflict. It may signal support, agreement or encouragement. It may show how comfortable a cadet is with what is being said or how committed they really are to their own words.

Reading Other's Body Language

Most people understand body language intuitively and quickly, and the conclusions that are reached go straight into the subconscious. However, it pays to look out for certain positive and negative signals. If other's body language is read correctly, one should know whether one's communications are succeeding or missing their mark.

| The Signal | What it may say |
|---|--|
| Nodding the head. | This cadet is listening to me. This cadet agrees with me. |
| Scratching the neck or rubbing eyes and looking at the ceiling (female) or the floor (man). | This cadet may not be telling the truth. |
| Clenched hands. | This cadet is frustrated. |
| Hand on cheek. | This cadet has some doubts. |
| Hand on cheek with thumb under chin. | This cadet is interested but has some doubts. |
| Picking off imaginary lint. | This cadet disagrees with or disproves of what has been said but is not willing to say so. |
| Crossed arms and legs. | This cadet is tuning out or filtering what is being said. |

One must be careful of a cadet's unspoken messages. Crossed arms may say "I feel threatened by what you are saying and I am closed to hearing it", but it may also say "I'm cold". A tapping foot may mean "I would like to be on my way", but it may also reflect a lot of nervous energy or a need to go to the washroom.

Look Out for Negative Signals

A cadet's body language may serve as an early warning signal that something is amiss in the communication process. Negative signals include:

- feet pointing away from the speaker;
- tapping feet;
- rapidly nodding the head;
- covering the nose;
- rubbing or scratching the neck or nose;
- looking skyward;
- avoiding or limiting eye contact;
- covering the mouth;
- body orienting away from the speaker;
- tense posture;
- covering or rubbing of the ears;
- "dancing" around;
- forming a fist, clenching the hands;
- rapidly exhaling breath;
- fidgeting (eg, tapping a pencil);
- drumming the fingers on the table; and
- buttoning the coat or jacket.

Boredom may look like:

- doodling;
- drumming the fingers;
- crossed legs with the foot swinging or kicking;
- head held in hands;
- a blank stare;
- taking deep breaths;
- tapping the floor with the foot; and
- clicking a pen in and out.

Frustration may look like:

- short breaths;
- "tssk" sounds;
- hands tightly clenched;
- fist-like gestures;
- wringing hands;
- pointing index fingers;
- running hands through the hair;
- rubbing the back of the neck; and
- kicking the ground at an imaginary object.

Look Out for Positive Signals

Just as body language may alert one to looming problems, it may also herald success. Positive signals include:

- nodding thoughtfully;
- relaxed posture;
- body oriented toward the speaker;
- open hands;
- feet pointed towards the speaker;
- stroking of the chin;
- open body position;
- eye contact, particularly when the pupils are dilated (enlarged);
- handling the documents or materials one is presenting; and
- thoughtful "um-hums".

Cooperation may look like:

- open hands;
- sitting on the edge of the chair;
- unbuttoning the coat or jacket;
- tilted head;
- leaning toward the speaker; and
- moving closer to the speaker.

Evaluation may look like:

- hand-to-face gestures;
- tilted head;
- stroking the chin or chin in the palm of the hand;
- taking their glasses off to clean them;
- sucking on a pen or glasses' arm; and
- peering over their glasses.



Distribute Appendix 3 to Attachment D to each cadet.

CONDUCT AN ACTIVITY WHERE CADETS READ NEGATIVE AND POSITIVE BODY LANGUAGE

Time: 20 min

OBJECTIVE

The objective of this activity is to have the cadets read negative and positive body language.

RESOURCES

Nil.

ACTIVITY LAYOUT

Nil.

ACTIVITY INSTRUCTIONS

1. Have cadets select a partner.
2. Select one set of partners to go first.
3. Have one cadet act as the sender while the other cadet acts as the receiver of the information.
4. Have the receiver select one body language signal to display throughout the sender's presentation.
5. Have the sender tell the receiver about everything they have done during the previous week.
6. Have the receiver display the body language selected throughout the sender's presentation.
7. Have the sender talk for approximately two minutes.
8. Have the sender guess what body language was being displayed.
9. Have the rest of the class guess what body language was being displayed.
10. Have the receiver confirm or deny the guesses. If the guesses were not correct, have the receiver explain what body language was being displayed.
11. Repeat Steps 5–10 until each set of partners has been both the sender and the receiver.

SAFETY

Nil.

CONDUCT A GROUP DISCUSSION ON THE COMMUNICATIONS SEMINAR

Time: 5 min



The purpose of the group discussion is to have cadets practice reflective thinking skills. Use the tips for answering / facilitating discussion and the suggested questions provided.

GROUP DISCUSSION



TIPS FOR ANSWERING / FACILITATING DISCUSSION:

- Establish ground rules for discussion, eg, everyone should listen respectfully; don't interrupt; only one person speaks at a time; no one's ideas should be made fun of; you can disagree with ideas but not with the person; try to understand others as much as you hope they understand you; etc.
- Sit the group in a circle, making sure all cadets can be seen by everyone else.
- Ask questions that will provoke thought; in other words avoid questions with yes or no answers.
- Manage time by ensuring the cadets stay on topic.
- Listen and respond in a way that indicates you have heard and understood the cadet. This can be done by paraphrasing their ideas.
- Give the cadets time to respond to your questions.
- Ensure every cadet has an opportunity to participate. One option is to go around the group and have each cadet answer the question with a short answer. Cadets must also have the option to pass if they wish.
- Additional questions should be prepared ahead of time.

SUGGESTED QUESTIONS:

- Q1. What have you learned during this seminar?
- Q2. Which activities did you enjoy during the seminar? Why?
- Q3. Will this information be useful to you?
- Q4. Where do you think you will use the information from this seminar?



Other questions and answers will develop throughout the group discussion. The group discussion should not be limited to only those suggested.



Reinforce those answers given and comments made during the group discussion, ensuring the teaching point has been covered.

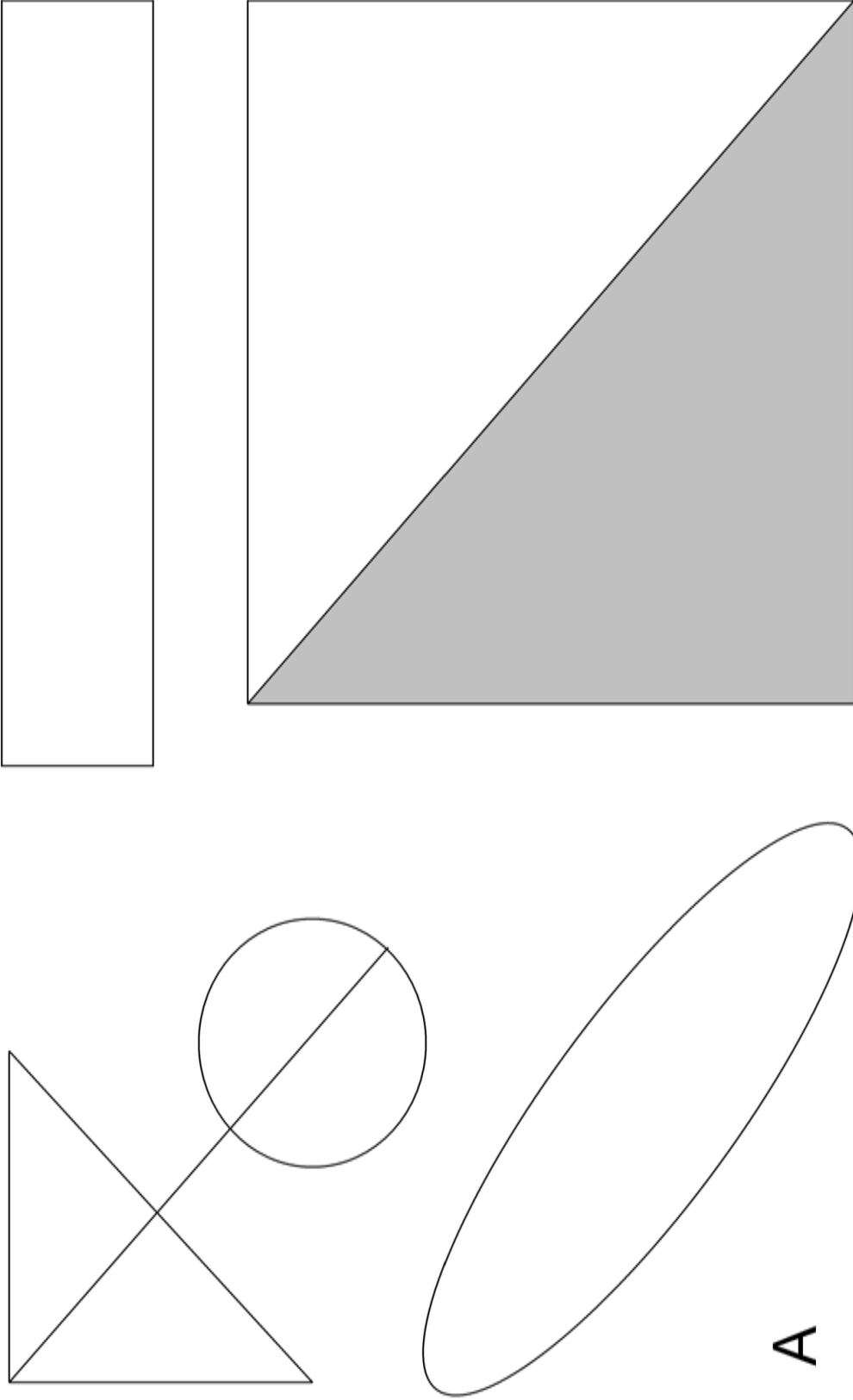

A

Figure D1-1 Picture A

Note. Created by Director Cadets 3, 2009, Ottawa, ON: Department of National Defence

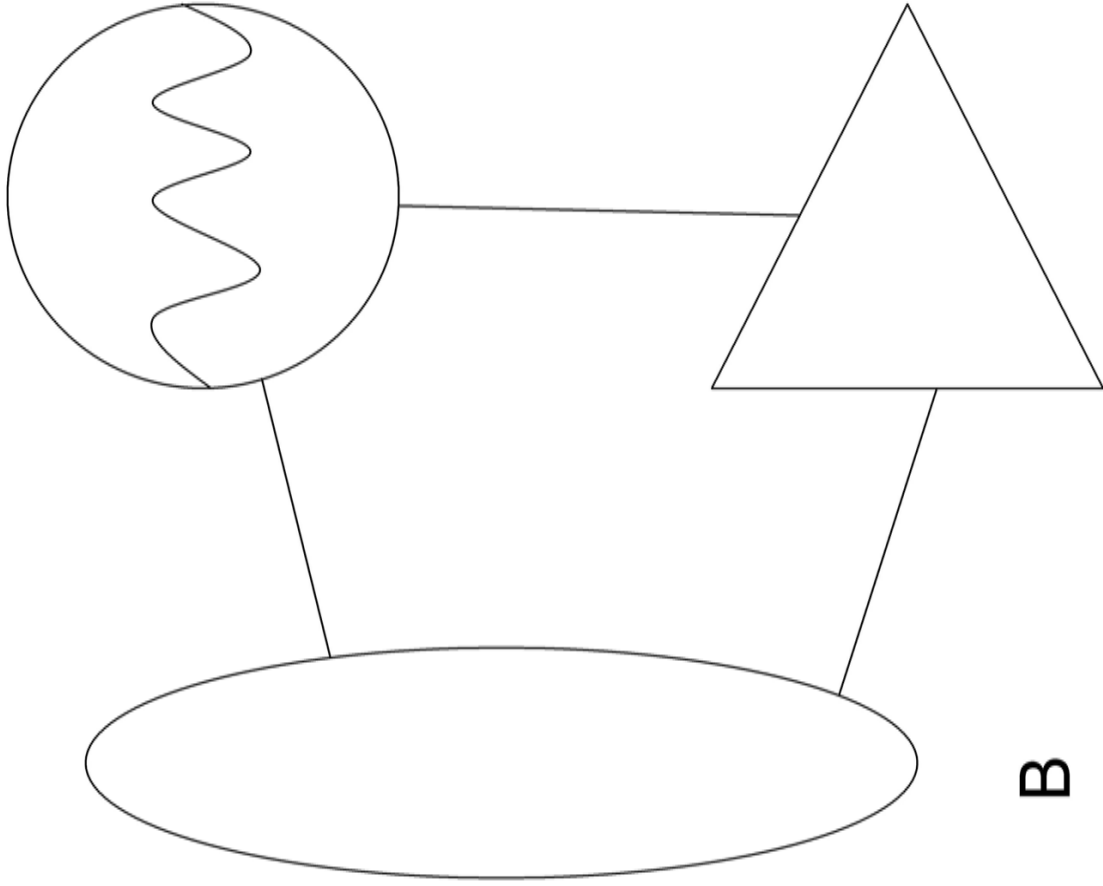

B

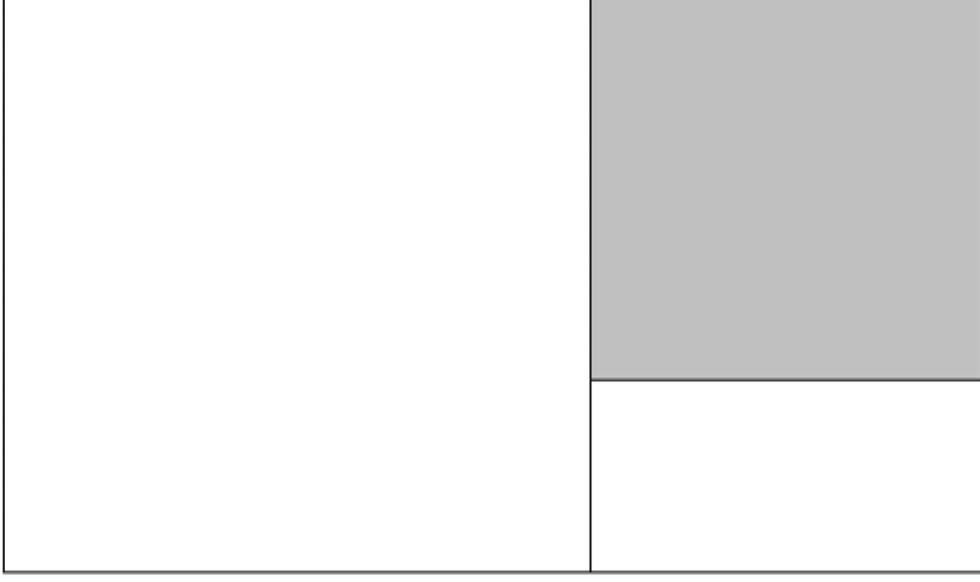

Figure D1-2 Picture B

Note. Created by Director Cadets 3, 2009, Ottawa, ON: Department of National Defence

SCENARIO FOR ROLE-PLAY

You are a second year cadet who is often timid and shy. You are often late to parade nights and you do not take care of your uniform very well. You attended the General Training (GT) course last summer and this summer you wish to attend the three-week Basic Musician Course.

THIS PAGE INTENTIONALLY LEFT BLANK

READING BODY LANGUAGE

Body language reveals a cadet's true thoughts. It may forewarn problems, such as lack of understanding, disagreement or budding conflict. It may signal support, agreement or encouragement. It may show how comfortable a cadet is with what is being said or how committed they really are to their own words.

Reading Other's Body Language

Most people understand body language intuitively and quickly, and the conclusions that are reached go straight into the subconscious. However, it pays to look out for certain positive and negative signals. If other's body language is read correctly, one should know whether one's communications are succeeding or missing their mark.

| The Signal | What it may say |
|---|--|
| Nodding the head. | This cadet is listening to me. This cadet agrees with me. |
| Scratching the neck or rubbing eyes and looking at the ceiling (female) or the floor (man). | This cadet may not be telling the truth. |
| Clenched hands. | This cadet is frustrated. |
| Hand on cheek. | This cadet has some doubts. |
| Hand on cheek with thumb under chin. | This cadet is interested but has some doubts. |
| Picking off imaginary lint. | This cadet disagrees with or disproves of what has been said but is not willing to say so. |
| Crossed arms and legs. | This cadet is tuning out or filtering what is being said. |

One must be careful of a cadet's unspoken messages. Crossed arms may say "I feel threatened by what you are saying and I am closed to hearing it", but it may also say "I'm cold". A tapping foot may mean "I would like to be on my way", but it may also reflect a lot of nervous energy or a need to go to the washroom.

Look Out for Negative Signals

A cadet's body language may serve as an early warning signal that something is amiss in the communication process. Negative signals include:

- feet pointing away from the speaker;
- tapping feet;
- rapidly nodding the head;
- covering the nose;
- rubbing or scratching the neck or nose;
- looking skyward;
- avoiding or limiting eye contact;
- covering the mouth;
- body orienting away from the speaker;
- tense posture;
- covering or rubbing of the ears;
- "dancing" around;
- forming a fist, clenching the hands;
- rapidly exhaling breath;
- fidgeting (eg, tapping a pencil);
- drumming the fingers on the table; and
- buttoning the coat or jacket.

Boredom may look like:

- doodling;
- drumming the fingers;
- crossed legs with the foot swinging or kicking;
- head held in hands;
- a blank stare;
- taking deep breaths;
- tapping the floor with the foot; and
- clicking a pen in and out.

Frustration may look like:

- short breaths;
- "tssk" sounds;
- hands tightly clenched;
- fist-like gestures;
- wringing hands;
- pointing index fingers;
- running hands through the hair;
- rubbing the back of the neck; and
- kicking the ground at an imaginary object.

Look Out for Positive Signals

Just as body language may alert one to looming problems, it may also herald success. Positive signals include:

- nodding thoughtfully;
- relaxed posture;
- body oriented toward the speaker;
- open hands;
- feet pointed towards the speaker;
- stroking of the chin;
- open body position;
- eye contact, particularly when the pupils are dilated (enlarged);
- handling the documents or materials one is presenting; and
- thoughtful "um-hums".

Cooperation may look like:

- open hands;
- sitting on the edge of the chair;
- unbuttoning the coat or jacket;
- tilted head;
- leaning toward the speaker; and
- moving closer to the speaker.

Evaluation may look like:

- hand-to-face gestures;
- tilted head;
- stroking the chin or chin in the palm of the hand;
- taking their glasses off to clean them;
- sucking on a pen or glasses' arm; and
- peering over their glasses.

LEADERSHIP SEMINAR SUPERVISION

Total Time: 90 min

PREPARATION

Photocopy Appendices 1 and 2 to Attachment E for each cadet.

The following components are conducted during this seminar:

| Number | Component | Time |
|--------|---|--------|
| 1 | Describe supervision systems. | 10 min |
| 2 | Explain how to supervise effectively. | 15 min |
| 3 | Conduct a group discussion on supervision. | 25 min |
| 4 | Conduct an activity where cadets create a supervision plan based on a scenario. | 25 min |
| 5 | Conduct a group discussion on the supervision seminar. | 5 min |

DESCRIBE SUPERVISION SYSTEMS

Time: 10 min

In general, the system of supervision will vary according to:

- the type of activity,
- the location of the activity,
- the age and skill of cadets, and
- the age and skill of the team leader / supervisor.

An assessment of the situation will determine the most appropriate supervision system to ensure the safety of cadets. The following systems may be used to cater to various situations.

Direct and Constant Supervision

Some activities require direct and constant supervision by a team leader to ensure all cadets remain safe. To determine whether direct and constant supervision is required, an assessment must be made on the level or risk involved in the activity and the skills and development of the cadets participating in the activity.

Intermittent Supervision

Intermittent supervision is appropriate for the supervision of more mature, responsible cadets participating in low-risk activities. Intermittent supervision must be well planned. The expectations for the cadets must be clearly stated and the cadets must be checked regularly.

Area Supervision

Area supervision requires a team leader to take responsibility for a particular area such as a basketball court or dining area. Area supervision allows cadets to move freely between areas and is easy to manage and plan.

Group Supervision

Group supervision relates to the supervision of a group of cadets regardless of the area they are in. Group supervision is more useful on excursions to venues where it is more difficult to supervise a large group of cadets or allow cadets to be grouped according to interest or skill level.

Floater Supervision

Floater supervision refers to a system where a team leader moves among all areas supporting and encouraging cadets and staff. The floater keeps track of the big picture and does not monitor a specific area or activity.

EXPLAIN HOW TO SUPERVISE EFFECTIVELY

Time: 15 min

Being totally aware of what is happening around and beyond a specific activity requires the development of specific supervision skills. These skills include:

- scanning;
- positioning;
- listening; and
- being "with it".

Scanning

Scanning involves regularly glancing around the whole area to see what is happening. By continually scanning the area, the team leader is able to quickly intervene in a situation where cadets could be at risk or intervene in a dispute.

Positioning

The physical position that the team leader takes will determine how well the team leader is able to supervise the cadets in their vicinity. Always position the body to be able to observe the maximum area possible. If the team leader is responsible for a high-risk activity, they must never leave the activity.

Listening

As well as positioning and scanning the area, the team leader will need to listen carefully to what is happening. As the team leader listens to cadets, they will learn the sounds that indicate that all is well or sounds that indicate something is not right.

Being "With It"

Being "with it" is the key to any supervision system. It is the desire and ability to be aware of:

- what has happened in the past;
- what is happening in the present; and
- what is likely to happen in the future.

Being "with it" requires the team leader to know the cadets in their care and monitor what they are doing. This includes all cadets' range of skills, interests, and their ability to interact with others. Being "with it" may enable the team leader to be aware of the positive behaviour displayed by cadets. The team leader may notice the leadership, perseverance, cooperation, and kindness of cadets.



Distribute Appendix 1 to Attachment E to each cadet.

CONDUCT A GROUP DISCUSSION ON SUPERVISION

Time: 25 min



The purpose of the group discussion is to have cadets practice reflective thinking skills. Use the tips for answering / facilitating discussion and the suggested questions provided.

GROUP DISCUSSION



TIPS FOR ANSWERING / FACILITATING DISCUSSION:

- Establish ground rules for discussion, eg, everyone should listen respectfully; don't interrupt; only one person speaks at a time; no one's ideas should be made fun of; you can disagree with ideas but not with the person; try to understand others as much as you hope they understand you; etc.
- Sit the group in a circle, making sure all cadets can be seen by everyone else.
- Ask questions that will provoke thought; in other words avoid questions with yes or no answers.
- Manage time by ensuring the cadets stay on topic.
- Listen and respond in a way that indicates you have heard and understood the cadet. This can be done by paraphrasing their ideas.
- Give the cadets time to respond to your questions.
- Ensure every cadet has an opportunity to participate. One option is to go around the group and have each cadet answer the question with a short answer. Cadets must also have the option to pass if they wish.
- Additional questions should be prepared ahead of time.

SUGGESTED QUESTIONS:

- Q1. Name some locations around the corps where the cadets will need to be supervised.
- Q2. How do you supervise these areas?
- Q3. Is supervision of cadets different in the classroom than in the rest of the building? Why or why not?
- Q4. Is supervision of cadets different in the canteen than in the rest of the building? Why or why not?

- Q5. Is supervision of cadets different on the range than in the rest of the building? Why or why not?
- Q6. How will you supervise the areas in the rest of the building (eg, washrooms, stairs, hallways)?
- Q7. Is supervision of cadets different when cadets are participating in an outdoor activity (eg, sailing, expedition, or launching rockets)?
- Q8. Give some examples of how and why the supervision is different?
- Q9. How does supervision lower the risks of those activities?
- Q10. Can supervision duties be delegated to others? Why or why not?



Other questions and answers will develop throughout the group discussion. The group discussion should not be limited to only those suggested.



Reinforce those answers given and comments made during the group discussion, ensuring the teaching point has been covered.

CONDUCT AN ACTIVITY WHERE CADETS CREATE A SUPERVISION PLAN BASED ON A SCENARIO

Time: 25 min

OBJECTIVE

The objective of this activity is to have the cadets create a supervision plan based on a scenario.

RESOURCES

- Scenario located at Appendix 2 to Attachment E,
- Paper, and
- Pen / pencil.

ACTIVITY LAYOUT

Nil.

ACTIVITY INSTRUCTIONS

1. Have the cadets find a partner.
2. Distribute the scenario to each pair of cadets.
3. Allow the cadets 15 minutes to create their supervision plan.
4. Have each pair present their supervision plan to the other cadets.
5. Allow one minute for questions and answers.

SAFETY

Nil.

CONDUCT A GROUP DISCUSSION ON THE SUPERVISION SEMINAR

Time: 5 min



The purpose of the group discussion is to have cadets practice reflective thinking skills. Use the tips for answering / facilitating discussion and the suggested questions provided.

GROUP DISCUSSION



TIPS FOR ANSWERING / FACILITATING DISCUSSION:

- Establish ground rules for discussion, eg, everyone should listen respectfully; don't interrupt; only one person speaks at a time; no one's ideas should be made fun of; you can disagree with ideas but not with the person; try to understand others as much as you hope they understand you; etc.
- Sit the group in a circle, making sure all cadets can be seen by everyone else.
- Ask questions that will provoke thought; in other words avoid questions with yes or no answers.
- Manage time by ensuring the cadets stay on topic.
- Listen and respond in a way that indicates you have heard and understood the cadet. This can be done by paraphrasing their ideas.
- Give the cadets time to respond to your questions.
- Ensure every cadet has an opportunity to participate. One option is to go around the group and have each cadet answer the question with a short answer. Cadets must also have the option to pass if they wish.
- Additional questions should be prepared ahead of time.

SUGGESTED QUESTIONS:

- Q1. What have you learned during this seminar?
- Q2. Which activities did you enjoy during the seminar? Why?
- Q3. Will this information be useful to you?
- Q4. Where do you think you will use the information from this seminar?



Other questions and answers will develop throughout the group discussion. The group discussion should not be limited to only those suggested.



Reinforce those answers given and comments made during the group discussion, ensuring the teaching point has been covered.

SUPERVISION SYSTEMS

In general, the system of supervision will vary according to:

- the type of activity,
- the location of the activity,
- the age and skill of cadets, and
- the age and skill of the team leader / supervisor.

An assessment of the situation will determine the most appropriate supervision system to ensure the safety of cadets. The following systems may be used to cater to various situations.

Direct and Constant Supervision

Some activities require direct and constant supervision by a team leader to ensure all cadets remain safe. To determine whether direct and constant supervision is required, an assessment must be made on the level of risk involved in the activity and the skills and development of the cadets participating in the activity.

Intermittent Supervision

Intermittent supervision is appropriate for the supervision of more mature, responsible cadets participating in low-risk activities. Intermittent supervision must be well planned. The expectations for the cadets must be clearly stated and the cadets must be checked regularly.

Area Supervision

Area supervision requires a team leader to take responsibility for a particular area such as a basketball court or dining area. Area supervision allows cadets to move freely between areas and is easy to manage and plan.

Group Supervision

Group supervision relates to the supervision of a group of cadets regardless of the area they are in. Group supervision is more useful on excursions to venues where it is more difficult to supervise a large group of cadets or allow cadets to be grouped according to interest or skill level.

Floater Supervision

Floater supervision refers to a system where a team leader moves among all areas supporting and encouraging cadets and staff. The floater keeps track of the big picture and does not monitor a specific area or activity.

HOW TO SUPERVISE EFFECTIVELY

Being totally aware of what is happening around and beyond a specific activity requires the development of specific supervision skills. These skills include:

- scanning;
- positioning;
- listening; and
- being "with it".

Scanning

Scanning involves regularly glancing around the whole area to see what is happening. By continually scanning the area, the team leader is able to quickly intervene in a situation where cadets could be at risk or intervene in a dispute.

Positioning

The physical position that the team leader takes will determine how well the team leader is able to supervise the cadets in their vicinity. Always position the body to be able to observe the maximum area possible. If the team leader is responsible for a high-risk activity, they must never leave the activity.

Listening

As well as positioning and scanning the area, the team leader will need to listen carefully to what is happening. As the team leader listens to cadets, they will learn the sounds that indicate that all is well or sounds that indicate something is not right.

Being "With It"

Being "with it" is the key to any supervision system. It is the desire and ability to be aware of:

- what has happened in the past;
- what is happening in the present; and
- what is likely to happen in the future.

Being "with it" requires the team leader to know the cadets in their care and monitor what they are doing. This includes all cadets' range of skills, interests, and their ability to interact with others. Being "with it" may enable the team leader to be aware of the positive behaviour displayed by cadets. The team leader may notice the leadership, perseverance, cooperation, and kindness of cadets.

SCENARIO FOR SUPERVISION PLAN

Your corps is going on a weekend citizenship tour. The corps will travel by bus approximately 150 kilometres. The bus will depart Saturday morning at 8:00 am. The first stop for the corps will be a museum. Lunch will occur at 12:00 pm on site at the museum. The bus will depart the museum and travel to a restaurant for supper at 4:30 pm. The bus will depart the fast food restaurant after one hour to drive to the armoury. The corps will spend the night sleeping in the armoury. On Sunday morning, breakfast will be brought to the armoury at 08:30 am. The bus will depart the armoury at 10:00 am to drive to a mall. Cadets will have lunch in the mall at the food court. The bus will depart the mall at 2:30 pm to return home.

The corps will take 15 Green Star cadets, 10 Red Star cadets, 7 Silver Star cadets, 4 Gold Star cadets, and 2 Master Cadet cadets. There will be 6 adult supervisors: 4 officers and 2 Civilian Instructors.

Create a supervision plan for the weekend activity using Silver Star, Gold Star and Master Cadet cadets. Adult supervisors may also be used.

THIS PAGE INTENTIONALLY LEFT BLANK



ROYAL CANADIAN ARMY CADETS
GOLD STAR
INSTRUCTIONAL GUIDE



SECTION 8

EO C403.02 – CONDUCT AN EVENING ACTIVITY DURING A FIELD TRAINING EXERCISE (FTX)

Total Time: 30 min

PREPARATION

PRE-LESSON INSTRUCTIONS

Resources needed for the delivery of this lesson are listed in the lesson specification located in A-CR-CCP-704/PG-001, *Gold Star Qualification Standard and Plan*, Chapter 4. Specific uses for said resources are identified throughout the instructional guide within the TP for which they are required.

Review the lesson content and become familiar with the material prior to delivering the lesson.

Photocopy Attachment A for every three cadets.

PRE-LESSON ASSIGNMENT

Nil.

APPROACH

A group discussion was chosen for TP 1 as it allows the cadets to interact with their peers and share their knowledge and opinions about selecting evening activities to conduct during an FTX. Sharing in the discussion encourages the cadets to examine their own thoughts and feelings and may prompt them to re-examine their previously held ideas. Participating in a group discussion improves the cadets' listening skills and team development.

An interactive lecture was chosen for TP 2 to orient the cadets to the format of an evening activity.

An in-class activity was chosen for TP 3 as it is an interactive way to provoke thought and stimulate interest among the cadets about conducting an evening activity during an FTX.

INTRODUCTION

REVIEW

Nil.

OBJECTIVES

By the end of this lesson the cadet shall be expected to conduct an evening activity during an FTX.

IMPORTANCE

It is important for cadets to know how to conduct evening activities. While completing an FTX, opportunities will arise for all cadets to complete activities after training hours. Knowing the stages of an evening activity, as well as what to do within each stage will help ensure that activities being conducted are fun, challenging and safe.

Teaching Point 1

Discuss considerations for selecting evening activities.

Time: 5 min

Method: Group Discussion

BACKGROUND KNOWLEDGE



The point of the group discussion is to draw the following information from the group using the tips for answering / facilitating discussion and the suggested questions provided.



All activities conducted during cadet training shall consider **safety** first and foremost. If an activity is considered to be unsafe or is becoming unsafe while it is being conducted, it shall be stopped immediately.



Activities that involve tackling, pushing, fighting, combat, verbal obscenities, etc shall not be conducted during any cadet training.

THE GOAL

In order to select an evening activity, the goal must be determined. In other words, why is the evening activity being conducted? Some possible goals are to:

- have fun;
- fill time;
- develop team-building skills;
- increase self-confidence; and
- participate in physical activity.

THE PARTICIPANTS

All participants should be able to participate in the activity. When members of the team do not know each other well, activities that are easy to understand should be selected. As participants begin to develop self-confidence and trust, more complicated activities may be conducted.



It is possible that some cadets will be unwilling to play. These cadets should not be forced to play. The leader(s) should somehow involve these cadets in the activity (eg, timekeeper, scorekeeper and referee). Once the activity is underway, it is possible that these cadets will want to join in.

The age of the participants should also be considered. What may be fun for Green Star cadets may not be fun for Silver Star cadets. It is also important to ensure that the activity selected can be accomplished based on the size of the team. Some activities may require less or more participants than available.

When activities require the participants to be grouped, consider the options. Different activities will require different groupings so it is important to determine if the participants can be grouped accordingly.

The following are examples of possible groups:

- star level / age,
- gender,
- experience,
- birthday months,
- height, etc.

RESOURCES

Ensure that the resources required to complete the activity are available. Having all resources available increases the chance of the activity being successful. At times, resources can be adapted.

TIME AVAILABLE

Some activities take longer to complete than others—know how much time is available. Select an activity that can be accomplished in the time allotted. Negative feelings and dynamics may develop when an activity has to be stopped or rushed.

SPACE AVAILABLE

Know how much space is available when selecting the activity. Some activities require an abundance of space, while others require a small area. When a selected activity requires more space than is available, it will most likely be unsafe / unsuccessful.

At times, it may not be possible to see the area where the activity will be completed. If the activity selected has specific restrictions, it is good practice to select a backup activity just in case.

WEATHER

The time of year and forecast are important considerations. When inclement weather is expected, make a plan to accommodate the needs of the participants (eg, rain gear, tarps, lanterns, extra clothing).

When activities are being conducted in cold weather, have a warm area available for participants that may become cold before, during or after the activity. Ensure all participants have warm clothing and always consider the possibility of frostbite.

There may be a time when the activity selected cannot be completed in certain weather conditions—always have a backup plan.

GROUP DISCUSSION



TIPS FOR ANSWERING / FACILITATING DISCUSSION:

- Establish ground rules for discussion, eg, everyone should listen respectfully; don't interrupt; only one person speaks at a time; no one's ideas should be made fun of; you can disagree with ideas but not with the person; try to understand others as much as you hope they understand you; etc.
- Sit the group in a circle, making sure all cadets can be seen by everyone else.
- Ask questions that will provoke thought; in other words avoid questions with yes or no answers.
- Manage time by ensuring the cadets stay on topic.
- Listen and respond in a way that indicates you have heard and understood the cadet. This can be done by paraphrasing their ideas.
- Give the cadets time to respond to your questions.
- Ensure every cadet has an opportunity to participate. One option is to go around the group and have each cadet answer the question with a short answer. Cadets must also have the option to pass if they wish.
- Additional questions should be prepared ahead of time.

SUGGESTED QUESTIONS:

- Q1. When selecting an evening activity to conduct during an FTX, what considerations must be made?
- Q2. Why are evening activities conducted during an FTX?
- Q3. How does selecting an activity for Gold Star cadets differ from selecting an activity with all star levels?
- Q4. Why is it important to know how much space is available when selecting an activity?
- Q5. If inclement weather is expected, what should you do?



Other questions and answers will develop throughout the group discussion. The group discussion should not be limited to only those suggested.



Reinforce those answers given and comments made during the group discussion, ensuring the teaching point has been covered.

CONFIRMATION OF TEACHING POINT 1

The cadets' participation in the group discussion will serve as the confirmation of this TP.

Teaching Point 2

Discuss the format of an evening activity.

Time: 5 min

Method: Interactive Lecture



The cadets, as a group, will be responsible to conduct an evening activity during an FTX. Stress the importance of following the prescribed format, especially when leading the activity as a group.



In the planning stage, tasks will be assigned so that the cadets have different responsibilities within the specified format. Each Gold Star cadet must be given a responsibility(s) throughout the activity.

It is good practice to try out the activity before conducting it. By completing the activity, the group can decide what tasks need to be assigned and predict if any aspect of the activity may need to be restructured.



Evening activities are usually followed by a night snack, which may include hot drinks and food. The evening activity can be planned so that the night snack is ready for the cadets immediately following its completion. This is good practice in cold weather conditions.

FORMAT FOR AN EVENING ACTIVITY

Set-Up

Always have the area set up, including placement of resources prior to the arrival of the participants. Ask the following questions before participants arrive:

- Are all of the required resources in place?
- Does everyone involved in conducting the activity have a clear understanding of their responsibilities?
- Is space sufficient?
- Can the weather be relied on? If not, is the back-up plan ready and achievable?

Introduction

An introduction should include the following:

- getting the group's attention;
- explaining the activity, specifically the rules;
- assigning teams and tasks as necessary;
- setting time limits;

- relaying any safety concerns; and
- motivating all participants.



Being enthusiastic during the introduction will help motivate the participants to complete the activity.

Conduct of the Activity

The following are responsibilities of the leader when conducting the activity:

- informing the participants when it is time to start the activity;
- supervising all participants;
- ensuring the goal(s) is achieved;
- stopping the activity if required; and
- ending the activity within the time limits.



Even the best and most fun activity may get boring if played for too long. Every activity has a high point and once this point has been reached, it is important to know when to move on. It is better to leave the group wanting to complete the activity again, rather than dreading it.



It is good practice to try fun ways of ending an activity, rather than simply yelling "STOP." Some examples of ways to end an activity could include:

- "Find someone who has a birthday in the same month",
- "Run to the north side of the field", and
- "Skip to the muster area".

Debriefing

As soon as the activity has been completed, a debriefing with all participants is required. The debriefing should consist of the following:

- reviewing the goal;
- providing feedback; and
- re-motivating the participants.



Questions used during the debriefing will vary, depending on the type of activity that was conducted. An effective debriefing will encourage cadets to construct their own interpretation of learning that occurred during the activity.

The following are examples of questions that can be used during a debriefing:

- Were there leaders who emerged within the group?
- Were there any individuals who did not interact well with others during the activity? How can the leader lessen the likelihood?
- Was it difficult to cooperate within the group? Why or why not?
- How many different ways were used to communicate? Which ways were most effective? Were there any barriers to communication during the activity?
- Did the team composition make it more difficult to complete the activity? Why or why not?
- What (if any) factors affected the morale of the group during the activity?

Tear Down

Once the activity has been completed, it is the leader's responsibility to ensure everything gets torn down and cleaned up. It is good practice to complete a quick sweep of areas that were used to ensure garbage has been cleaned up and nothing has been left behind.

CONFIRMATION OF TEACHING POINT 2

QUESTIONS:

- Q1. What are the five stages in the format of an evening activity?
- Q2. What responsibilities does a leader have when conducting an evening activity?
- Q3. What are some questions that can be used during a debriefing?

ANTICIPATED ANSWERS:

- A1. The five stages are:
1. set-up;
 2. introduction;
 3. conduct of the activity;
 4. debriefing; and
 5. tear down.
- A2. The following are responsibilities of the leader when conducting the activity:
- informing the participants when it is time to start the activity;
 - supervising all participants;
 - ensuring the goal(s) is achieved;

- stopping the activity if required; and
- ending the activity within the time limits.

A3. The following are examples of questions that can be used during a debriefing:

- Were there leaders who emerged within the group?
- Were there any individuals who did not interact well with others during the activity? How can the leader lessen the likelihood?
- Was it difficult to cooperate within the group? Why or why not?
- How many different ways were used to communicate? Which ways were most effective? Were there any barriers to communication during the activity?
- Did the team composition make it more difficult to complete the activity? Why or why not?
- What (if any) factors affected the morale of the group during the activity?

Teaching Point 3

Have the cadets, as one group, prepare an evening activity to be conducted during an FTX.

Time: 15 min

Method: In-Class Activity

ACTIVITY

OBJECTIVE

The objective of this activity is to have the cadets, as one a group, prepare an evening activity to be conducted during an upcoming FTX.

RESOURCES

- Evening Activities located at Attachment A,
- Paper, and
- Pens / pencils.

ACTIVITY LAYOUT

Place chairs / desks in a circle or U-shape so that all cadets can see each other.

ACTIVITY INSTRUCTIONS

1. Explain to the cadets that they have 15 minutes to:
 - a. select one activity to conduct with the Green, Red and Silver Star cadets during an upcoming FTX;



Cadets may alter the activity chosen from Attachment A or choose an activity that has not been included. Samples may be used / altered as desired.

- b. identify resources that will be required to conduct the activity; and
- c. assign tasks to team members.



Each cadet shall be assigned a responsibility(s) when conducting the evening activity during an FTX.

2. Have the cadets, as a group, prepare an evening activity to be conducted during an FTX.



Walk around and provide assistance when required / requested.

After this lesson has been completed, ensure the corps training officer or officer in charge of the FTX is aware of the resource requirements for the activity selected.

There is no more time allocated to prepare the evening activity.

SAFETY

Nil.

CONFIRMATION OF TEACHING POINT 3

The cadets' participation in the activity will serve as the confirmation of this TP.

END OF LESSON CONFIRMATION

The cadets' participation in preparing an evening activity to be conducted during an FTX will serve as the confirmation of this lesson.

CONCLUSION

HOMEWORK / READING / PRACTICE

Where extra time is required, the work shall be completed as homework.

METHOD OF EVALUATION

Nil.

CLOSING STATEMENT

When asked to conduct an activity, the first step is to plan. Knowing how to select and prepare an activity will help ensure success when conducting it. Throughout corps FTXs, there will be many opportunities to conduct evening activities.

INSTRUCTOR NOTES / REMARKS

Evening activities shall be conducted by the Gold Star cadets (as one group), during an FTX.

REFERENCES

C0-114 ISBN 0-02-863656-2 Pell, A. R. (1999). *The complete idiot's guide to team building*. Indianapolis, IN: Alpha Books.

C0-245 ISBN 1-58062-513-4 Adams, B. (2001). *The everything leadership book*. Avon, MA: Adams Media.

C0-254 ISBN 0-7894-3244-7 Heller, R. (1998). *Communicate clearly*. New York, NY: DK Publishing, Inc.

C2-100 ISBN 0-7872-0107-3 Project Adventure, Inc. (1995). *Youth leadership in action: A guide to cooperative games and group activities written by and for youth leaders*. Dubuque, IO: Kendall / Hunt Publishing Company.

C2-151 ISBN 0-7360-4709-3 Gilbertson, K., Bates, T., McLaughlin, T., & Ewert, A. (2006). *Outdoor education: Methods and strategies*. Windsor, ON: Human Kinetics.

EVENING ACTIVITIES

NATURE SCAVENGER HUNT

Evening Activity

REQUIRED RESOURCES

- Nature Scavenger Hunt worksheet (one per team),
- Pens / pencils (two per team),
- Bag to collect items (one per team),
- Compass (one per team), and
- Flashlight (one per team and for each safety person).

PREPARATION

- Determine boundaries for the activity.
- Create a Nature Scavenger Hunt worksheet that lists the items to find (see sample below).

INSTRUCTIONS

1. Divide the cadets into teams of four.
2. Explain that the objective of the activity is to retrieve as many scavenger hunt items as possible in the allotted time. Items cannot be used twice (eg, a pop can cannot also be used as a piece of litter). Each item shall be ticked off on the worksheet as it is located.
3. Describe the boundaries for the activity.
4. Distribute a Nature Scavenger Hunt worksheet, pens / pencils, a compass and a flashlight to each team.
5. Allow 40 minutes for the cadets to complete the activity.
6. Once time is up, collect all worksheets and tally the number of items collected by each team. The team with the most items is the winner.

SAFETY CONSIDERATIONS

- All cadets must be aware of the boundaries for the activity.
- Have personnel scattered in the area and along the boundaries with flashlights to ensure cadets stay within the set boundaries.
- Provide the cadets and staff with a safety bearing.

NATURE SCAVENGER HUNT



| | |
|--|---|
| <input type="checkbox"/> A shiny rock. | <input type="checkbox"/> A smooth rock. |
| <input type="checkbox"/> Something prickly. | <input type="checkbox"/> A leaf with worm / insect holes. |
| <input type="checkbox"/> A branch in the shape of a Y. | <input type="checkbox"/> A feather. |
| <input type="checkbox"/> A three-leaf clover. | <input type="checkbox"/> A pop can. |
| <input type="checkbox"/> Something interesting. | <input type="checkbox"/> A plant growing on a non-living thing. |
| <input type="checkbox"/> Something that smells nice. | <input type="checkbox"/> Something soft. |
| <input type="checkbox"/> Something red. | <input type="checkbox"/> A yellow leaf. |
| <input type="checkbox"/> A flower. | <input type="checkbox"/> A pine cone. |
| <input type="checkbox"/> A rock with a minimum of three colours. | <input type="checkbox"/> A berry. |
| <input type="checkbox"/> A piece of rope. | <input type="checkbox"/> Something sticky. |
| <input type="checkbox"/> A shell. | <input type="checkbox"/> A piece of bark. |
| <input type="checkbox"/> Something blue. | <input type="checkbox"/> Something furry. |
| <input type="checkbox"/> Something that looks happy. | <input type="checkbox"/> Something that looks sad. |
| <input type="checkbox"/> A piece of litter. | <input type="checkbox"/> A red leaf. |
| <input type="checkbox"/> A penny. | <input type="checkbox"/> A sticky note. |
| <input type="checkbox"/> A pen. | <input type="checkbox"/> A highlighter. |

FLAGS

Evening Activity

REQUIRED RESOURCES

- Flags (two different colours),
- Rope (approximately 10 m),
- Flashlights (six), and
- A whistle.

PREPARATION

- Select a large area with some obstacles (eg, trees, fences, small hills, large rocks, small bushes). Mark the middle of the area.
- Pick a centrally located area to be the lounge area and clearly mark it with rope (approximately 5 m wide and 5 m long).

INSTRUCTIONS

1. Brief the cadets on the following rules for the activity:
 - a. The objective of the activity is to locate the other team's flag, take it and carry it back to the other side without being tagged.
 - b. Each team has a territory—half of the area.
 - c. When a member of the opposite team enters your team's territory, you can tag them. You cannot tag a member of the opposite team if you are in their territory. Once tagged, the person must go directly to the lounge, where they will remain until saved by a member of their team. Saving can only occur in the lounge area by being tagged by a member of the same team.
 - d. Items can be placed in the lounge that would attract cadets to stay there, if desired by the teams.
 - e. Cadets who tackle / grab will be removed from participating in the activity.
 - f. Flags cannot be hidden or buried.
 - g. Winning can only occur when the flag is brought to the opposing team's side. If tagged when carrying the flag, the flag must be brought back to the appropriate side and repositioned and the participant must go to the lounge area.
 - h. If three blasts of the whistle are heard at any point, all cadets shall meet in the middle of the area.
2. Divide the cadets into two teams and assign sides of the area to each team (eg, Team 1—north side, Team 2—south side).
3. Allow approximately 10 minutes for the teams to go to their areas, position their flag, discuss strategy and set up the lounge area (if desired). The teams may choose to select a captain.
4. Begin the activity. Allow 40 minutes to participate in the activity.
5. If a flag is located and brought to the other side early on, try the activity again.

SAFETY CONSIDERATIONS

- Have personnel scattered in the area and along the boundaries with flashlights to ensure cadets stay within the set boundaries.
- Ensure tagging is occurring, not tackling / grabbing.

STRATEGO

Evening Activity

REQUIRED RESOURCES

- Pylons / markers (10),
- Measuring tape,
- Pool noodles (one per five cadets),
- Foam balls (two per five cadets),
- Two different coloured pinnies (one pinnie per cadet), and
- Dual-mantle lanterns (four).

PREPARATION

- Select an open area approximately 20 m long and 10 m wide (size may be altered, depending on cadet corps size).
- Set up the area with pylons / markers as per Figure A-1.
- Position lanterns approximately 5 m behind the boundaries for light and safety.

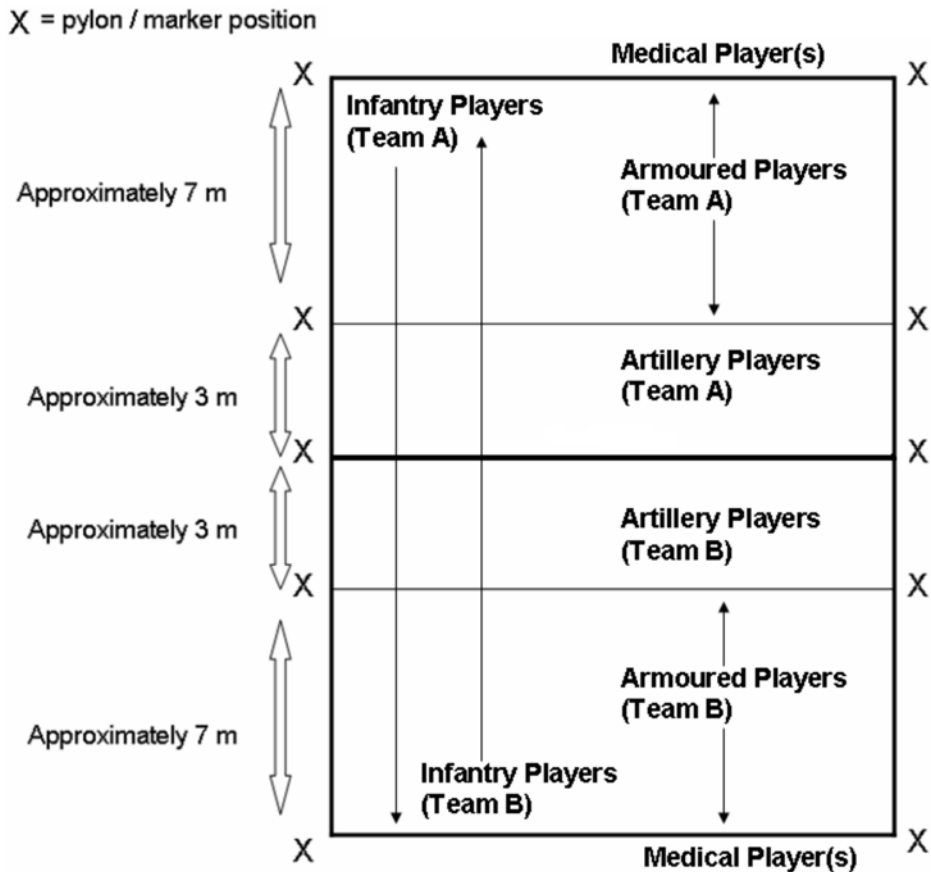

Figure A-1 Stratego Playing Field

Note. Created by Director Cadets 3, 2009, Ottawa, ON: Department of National Defence.

INSTRUCTIONS

1. Brief the cadets on the following rules for the activity:
 - a. The objective of the game is to tag out all of the members of the opposite team.
 - b. There are four arms of the Canadian Army on each team—infantry, armoured, artillery and medical.
 - c. Infantry players will tag players from the opposite team. Once a player from the opposite team is tagged by an infantry player, they must lie down on the ground and await the arrival of the medic.
 - d. Artillery players will have foam balls. Once a player from the opposite team is hit with a foam ball, they must lie down on the ground and await the arrival of the medic. Foam balls shall never be aimed toward a player's face. If a player throws a ball extremely hard at another member when they are in close proximity (less than 2 m), they will be removed from the activity.
 - e. Armoured players will have pool noodles. Once a player from the opposite team is hit with a pool noodle, they must lie down on the ground and await the arrival of the medic. Pool noodles shall never be aimed higher than the chest of the other player.

- f. The medical player(s) will manoeuvre around the playing field, saving other players. In order to save a player, the medical player(s) must reach the player and escort them to the back of the field. Both players must be touching (eg, holding hands, medical player's hand on the other player's arm). Once both players have reached the back of the field, the player who was saved may resume the game. Medical players can be tagged when saving another player.
 - g. Each arm has an area of the playing field, as illustrated in Figure A-1. Infantry players can manoeuvre anywhere on the field (throughout both team's sides). Artillery players must remain between the centre line and the pylon positioned behind them, on their own side. Armoured players must remain behind the first pylon, behind the centre line on their own side. The medical player(s) may manoeuvre anywhere on the field (throughout both team's sides).
 - h. Only armoured players can use the pool noodles. When an armoured player is tagged / hit, they must drop the pool noodle. No other player can use the pool noodle. If the armoured player is saved, he / she may use the pool noodle again.
 - i. Foam balls can only be used by artillery players. Other players may pass foam balls to artillery players, but only artillery players can throw them.
 - j. Only infantry players can tag other players.
 - k. Only the medical player(s) can save other players.
2. Divide the cadets into two equal groups. Have each group don their coloured pinney.
 3. Each group will assign infantry, armoured, artillery and a medical player(s). Based on 30 players or two teams with 15 players, the following would suffice:
 - a. infantry players—seven,
 - b. artillery players—three,
 - c. armoured players—four, and
 - d. medical player—one.
 4. Distribute equipment to the players.
 5. Have everyone take their positions on the playing field.
 6. Position personnel along the playing field to watch for safety and fair play.
 7. Begin the activity.
 8. Judge time accordingly. The activity may be played multiple times, within the set time limit.

SAFETY CONSIDERATIONS

- Ensure tagging is occurring, not tackling / grabbing.
- Foam balls shall never be aimed toward a player's face. If a player throws a ball extremely hard at another member when they are in close proximity (less than 2 m), they will be removed from the activity.
- Players shall never aim for another cadet above the chest when using a pool noodle.
- This activity should occur early in the evening.

LANTERNS

Evening Activity

REQUIRED RESOURCES

- Topographical map of the area (one per team),
- Compass or Global Positioning System (GPS) receiver (one per team),
- Flashlights (10),
- Index card (one per team),
- Pen / pencil (one per team),
- Glow Sticks (one per each wolf),
- Whistle (one per team), and
- A stopwatch.

PREPARATION

- Select a large area with some obstacles (eg, trees, fences, small hills, large rocks, small bushes).
- Set up a course with multiple points (minimum of 10). Assign a numerical value to each point. A sample point allocation is illustrated in Figure A-2.
- Mark all points on each topographical map, as well as the point value for each.
- Clearly define and mark the start and finish points.
- Position an assistant instructor at each checkpoint, with a flashlight.
- Position wolves (assistant instructors) in the area, each with a Glow Stick visible somewhere on their body (based on 10 points, four wolves would suffice).

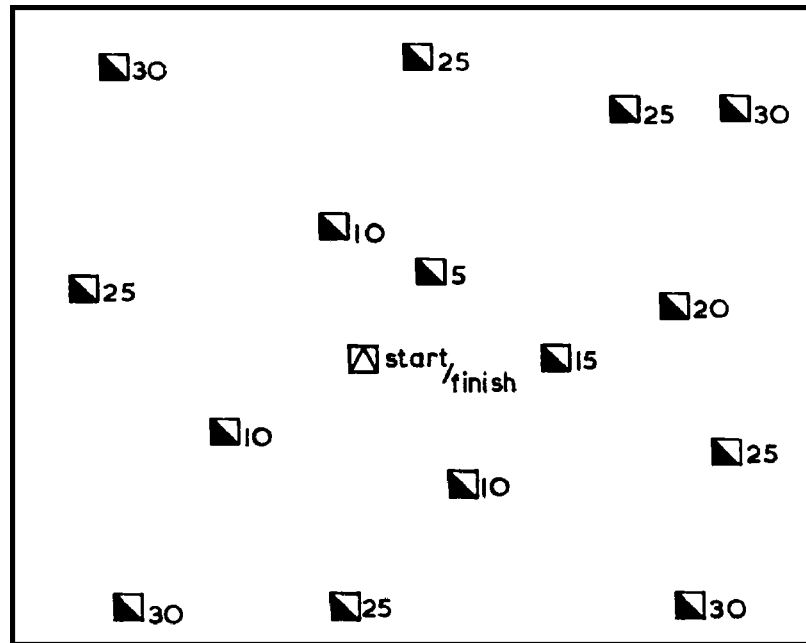

Figure A-2 Sample Score Layout

Note. From *Orienteering: An Aid to Training* (p. 22), by M.J. Summers, 1968, London, England: Hillside Printing & Publishing Co. Copyright 1968 by Captain M. J. Summers.

INSTRUCTIONS

1. Divide the cadets into teams of no more than four. Have each team decide on a team name.
2. Brief the cadets on the following rules for the activity:
 - a. Each team will be given a topographical map indicating each possible checkpoint (along with the checkpoint's numerical value), a compass or GPS receiver, an index card and a pen / pencil.
 - b. The objective of the activity is to reach as many checkpoints as possible, in the fastest time. The order in which the checkpoints are reached does not matter.
 - c. There will be wolves in the area. Each wolf has a Glow Stick on them as a way to make them somewhat visible in the dark. Wolves can tag players at anytime, unless the players are within 2 m of a point. When any team member is tagged, the team is penalized 2 points off their final score. Wolves cannot linger around checkpoints, nor can they instantly double tag members of a team. The wolf must initial the team's index card, to indicate that they have been tagged.
 - d. There will be assistant instructors at each point, randomly flashing their flashlight to help teams get to the checkpoint. Once a team has reached the checkpoint, the assistant instructor must initial the team's index card, to indicate that they have been reached the checkpoint.
 - e. Each team will have a whistle. Whistles shall be blown three times in case of emergency.
 - f. There will be 60 minutes allotted to complete the activity.
3. Issue each team the required equipment. Have each team set up their index card as illustrated in Figure A-3.
4. Start the teams at two-minute intervals and record the start times.

5. Allow approximately 60 minutes to complete the activity.
6. Once all teams have crossed the finish line, tally up the scores.

| CHECKPOINTS | WOLVES |
|--------------------|---------------|
| | |

Figure A-3 Sample Index Card Layout

Note. Created by Director Cadets 3, 2009, Ottawa, ON: Department of National Defence.

SAFETY CONSIDERATIONS

- All cadets must be aware of the boundaries for the activity.
- Have personnel scattered in the area and along the boundaries with flashlights to ensure cadets stay within the set boundaries.
- Provide the cadets and staff with a safety bearing.
- Whistles shall be blown three times in case of emergency or as an indication for all cadets to meet at the muster area.

NIGHT PUZZLE NAVIGATION

Evening Activity

REQUIRED RESOURCES

- Topographical map of the area (one per team),
- Compass (one per team),
- Individual puzzle pieces (one per team, per checkpoint),
- A predetermined navigation route,
- Whistle (one per team), and
- Flashlights (one per team).

PREPARATION

- Develop a puzzle and position pieces at each checkpoint. Each checkpoint will contain multiple identical pieces, since each team will have to take one piece with them along the route. See Figure A-4 for a sample puzzle.
- Clearly define and mark the start and finish points.
- Mark the route on the topographical maps.

INSTRUCTIONS

1. Divide the cadets into groups of four to six.
2. Issue each group a map, a compass, a whistle and a flashlight. Whistles shall be blown three times in case of emergency.
3. Start the teams at two-minute intervals and record the start times.
4. Have the teams collect one piece of the puzzle from each checkpoint.
5. Once across the finish line, have the teams solve the puzzle.

SAFETY CONSIDERATIONS

- If possible, have personnel positioned at each checkpoint to give each team the puzzle piece, answer questions and to prevent teams from following each other or sharing answers.
- Provide the cadets and staff with a safety bearing.

VARIATION

Instead of a puzzle, there could be riddle pieces located at each checkpoint. See Figure A-5 for a sample riddle (the answer to the riddle is a puzzle piece).

SAMPLE NAVIGATION PUZZLE

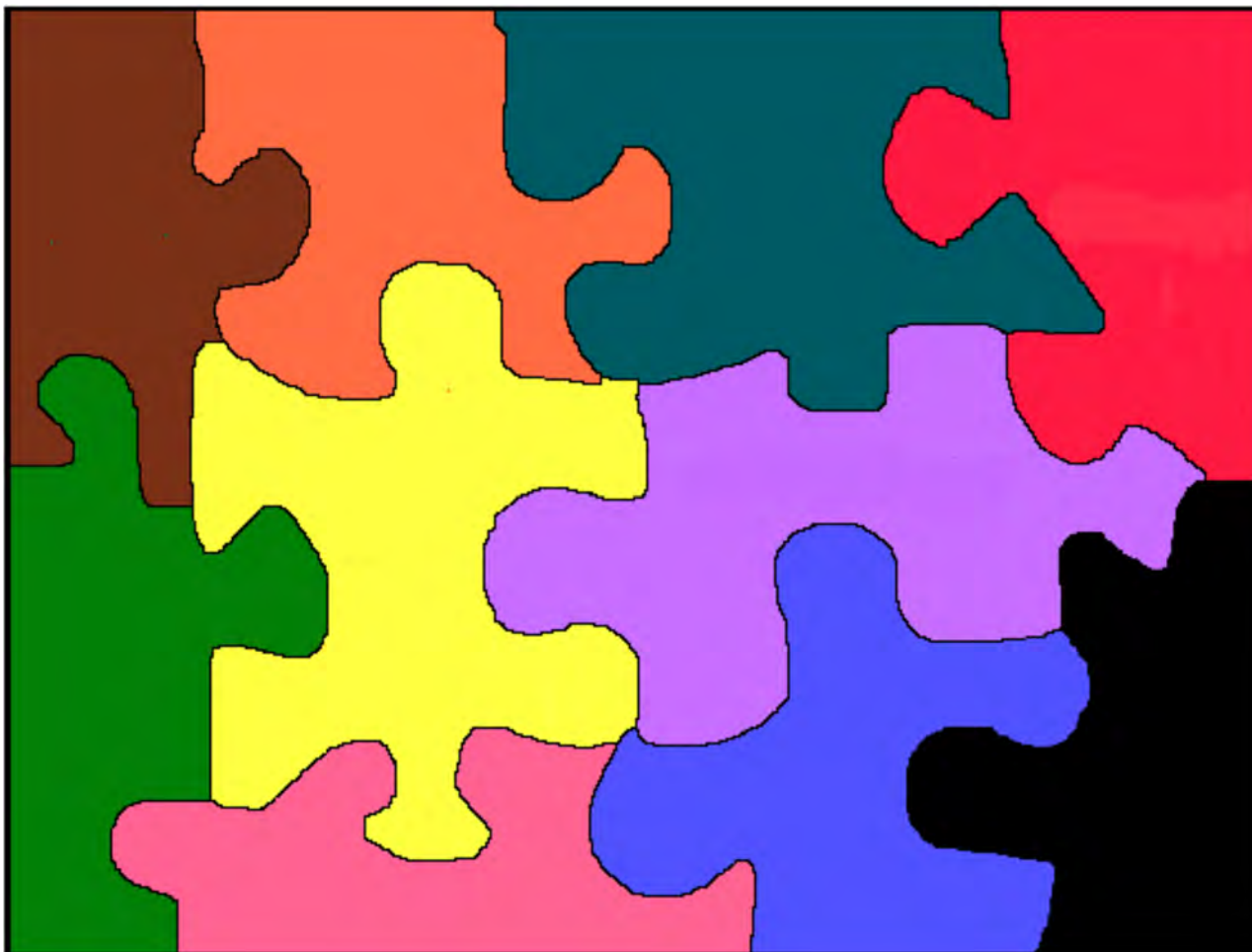

Figure A-4 Sample Puzzle

Note. Created by Director Cadets 3, 2007, Ottawa, ON: Department of National Defence.

SAMPLE NAVIGATION RIDDLE

| |
|---|
| 1. I come in different shapes and sizes. |
| 2. Parts of me are curved |
| 3. others are straight. |
| 4. You can put me anywhere you like |
| 5. but there's only |
| 6. one right place for me. |
| 7. What am I? |

Figure A-5 Sample Riddle

Note. Created by D Cdts 3, 2007, Ottawa, ON: Department of National Defence.

WHOOO?

Evening Activity

REQUIRED RESOURCES

- Pieces of paper (12 per owl),
- Pen / pencil (five), and
- Whistle (one).

PREPARATION

- Select a large, preferably wooded, area with some obstacles (eg, trees, fences, small hills, large rocks, small bushes).
- Determine boundaries for the activity.

INSTRUCTIONS

1. Brief the cadets on the following rules for the activity:
 - a. Cadets will be designated as owls and wolves.
 - b. Owls will hide in the area, trying to blend into the surroundings. Each owl will have 12 pieces of paper, indicating a number or initials specific to that person.
 - c. The wolves will search out the owls. When a wolf finds an owl, the owl will give the wolf a piece of paper.
 - d. The owl has the option to make sounds (eg, animal sounds, clapping) occasionally in order to help the wolves.
 - e. When a wolf makes contact with an owl, the owl will soundlessly hand over a piece a paper.
 - f. When a wolf has collected a predetermined number of pieces of paper or time has elapsed, they will return to the muster area.
2. Appoint the owls. Generally, there should be one owl for every five wolves. Distribute 12 pieces of paper to each and have them place a specific number or their initials on each piece.
3. Determine the number of pieces of paper a participant requires before heading back to the muster area, as well as a time limit for the activity.
4. Allow approximately five minutes for the owls to hide.
5. Begin the activity.

SAFETY CONSIDERATIONS

Have personnel scattered in the area and along the boundaries with flashlights to ensure cadets stay within the set boundaries.

REFERENCE

ISBN 0-8403-5682-X Rohnke, K. (1984). *Silver bullets: A guide to initiative problems, adventure games and trust activities*. (p. 75). Dubuque, IA: Kendall/Hunt Publishing Company.



**COMMON TRAINING
ALL TRAINING LEVELS
INSTRUCTIONAL GUIDE**



PERSONAL FITNESS AND HEALTHY LIVING

SECTION 1

PO X04 – TRACK PARTICIPATION IN PHYSICAL ACTIVITIES

Total Time:

For the following EOs, refer to the lesson specifications located in A-CR-CCP-701/PG-001, *Royal Canadian Army Cadets Green Star Qualification Standard and Plan*:

- CX04.01 – Participate in the Cadet Fitness Assessment and Identify Strategies for Improving Personal Physical Fitness,
- CX04.03 – Participate in a Cooking Class,
- CX04.04 – Attend a Personal Fitness and Healthy Living Presentation, and
- CX04.05 – Attend a Local Amateur Sporting Event.

For the following EOs, refer to the instructional guides located in A-CR-CCP-701/PF-001, *Royal Canadian Army Cadets Green Star Instructional Guides*:

- MX04.01 – Participate in 60 Minutes of Moderate- to Vigorous-Intensity Physical Activity (MVPA) and Track Participation in Physical Activities,
- MX04.02 – Identify Strategies to Improve Participation in Physical Activities and Participate in the Cadet Fitness Assessment,
- MX04.03 – Participate in the Cadet Fitness Assessment and Identify Strategies for Improving Personal Physical Fitness, and
- CX04.02 – Participate in Activities that Reinforce the Three Components of Physical Fitness.

THIS PAGE INTENTIONALLY LEFT BLANK



**COMMON TRAINING
ALL TRAINING LEVELS
INSTRUCTIONAL GUIDE
PHYSICAL ACTIVITIES**



SECTION 1

PO X05 – PARTICIPATE IN PHYSICAL ACTIVITIES

Total Time:

For the following EOs, refer to the instructional guides located in A-CR-CCP-701/PF-001, *Royal Canadian Army Cadets Green Star Instructional Guides*:

- MX05.01 – Participate in Physical Activities,
- CX05.01 – Participate in Physical Activities, and
- CX05.02 – Participate in a Tournament.

THIS PAGE INTENTIONALLY LEFT BLANK



**COMMON TRAINING
GOLD STAR
INSTRUCTIONAL GUIDE**



SECTION 1

EO M406.01 – PARTICIPATE IN A RECREATIONAL MARKSMANSHIP ACTIVITY

Total Time:

90 min

PREPARATION

PRE-LESSON INSTRUCTIONS

Resources needed for the delivery of this lesson are listed in the lesson specification located in A-CR-CCP-704/PG-001, *Gold Star Qualification Standard and Plan*, Chapter 4. Specific uses for said resources are identified throughout the instructional guide within the TP for which they are required.

Review the lesson content, unit range standing orders, and become familiar with the material prior to delivering the lesson.

Photocopy the targets located at Attachments B–J as required.

Construct a range IAW A-CR-CCP-177/PT-001, *Canadian Cadet Movement: Cadet Marksmanship Program Reference Manual*.

PRE-LESSON ASSIGNMENT

Nil.

APPROACH

A practical activity was chosen for this lesson as it is an interactive way to allow the cadet to experience recreational marksmanship in a safe and controlled environment. This activity contributes to the development of marksmanship skills and knowledge in a fun and challenging setting.

INTRODUCTION

REVIEW

The review for this lesson will be from EO M106.02 (Carry Out Safety Precautions on the Cadet Air Rifle).

QUESTIONS:

- Q1. Why do we follow safety regulations?
- Q2. How would you verify the safety catch is ON?
- Q3. What are the four “ACTS” of firearm safety?

ANTICIPATED ANSWERS:

- A1. We follow safety regulations to prevent accidents with the cadet air rifle.
- A2. When the safety is ON, no red can be seen.
- A3. The mnemonic “ACTS” stands for:
- Assume every firearm is loaded.
 - Control the muzzle direction at all times.
 - Trigger finger must be kept off the trigger and out of the trigger guard.
 - See that the firearm is unloaded (prove it safe).

OBJECTIVES

By the end of this lesson the cadet shall have participated in a recreational marksmanship activity.

IMPORTANCE

It is important for cadets to participate in a recreational marksmanship activity because it allows them to experience marksmanship in a fun, dynamic and safe setting.

Teaching Point 1**Supervise the cadet's participation in a recreational marksmanship activity.**

Time: 80 min

Method: Practical Activity



A range briefing is conducted to pass on vital information and answer any questions the cadets may have prior to participating in a marksmanship activity. The range briefing is required to ensure the safe execution of a marksmanship activity.

CONDUCT A RANGE BRIEFING

1. Explain pertinent sections of the local range standing orders.
2. Review general rules observed on all ranges, to include:
 - a. proving that rifles are safe prior to being picked up, handed to or received from another person;
 - b. never pointing rifles at people;
 - c. inserting safety rods into the barrels of rifles when not in use on the range;
 - d. never horseplaying on a range;
 - e. always pointing rifles down range; and
 - f. following the Range Safety Officer's (RSO) directions and orders at all times.



Review range commands with an explanation and demonstration for each command.
All loading / firing is to be simulated.

3. Review commands used on an air rifle range (as illustrated in Figure 1).

| COMMAND | ACTION TO BE TAKEN |
|---|---|
| Cover off your firing point | Stand up, move behind the firing point and await further commands. |
| Place your equipment down and stand back | Lay the equipment down on the mat and stand back when finished. |
| Adopt the prone position | Adopt the prone position, pick up the rifle, ready the equipment and put on hearing and eye protection. |
| Type of firing (GRIT) | GRIT is the acronym for: 1. Group (relay), 2. Range (distance), 3. Indication (number of rounds), and 4. Type (grouping, scored). |
| Relay, load | 1. Pick up and hold the rifle with the dominant hand. 2. Ensure the safety catch is in the “ON” position. 3. Pump the rifle, observing a three-second pause. 4. Load a pellet (flat end forward). 5. Close the bolt. |
| Relay, fire | 1. Place the safety catch in the “OFF” position. 2. Aim the rifle at the target. 3. Squeeze the trigger. 4. Open the bolt. 5. Repeat the following sequence for each shot: (a) Pump the rifle, observing a three-second pause. (b) Load a pellet (flat end forward). (c) Close the bolt. (d) Aim the rifle at the target. (e) Squeeze the trigger. (f) Open the bolt. 6. Place the safety in the “ON” position. 7. Partially open the pump lever. 8. Lay down the rifle. |

Figure 1 Air Rifle Range Commands

Note. Created by Director Cadets 3, 2006, Ottawa, ON: Department of National Defence.

4. Describe the layout of the air rifle range.
5. Review hand-washing procedures on completion of firing. This is important because each time a person handles pellets, a small trace of lead is left on their hands. To decrease the risk of lead poisoning, it is important that all persons wash their hands thoroughly after handling pellets.

ACTIVITY

OBJECTIVE

The objective of this activity is to have the cadets participate in a recreational marksmanship activity.

RESOURCES

- Cadet air rifle (one per firing lane),
- Cadet air rifle sling (one per cadet),
- Air rifle pellets (as per activity chosen),
- Target frames (one per firing lane),
- Targets (as per activity chosen),
- Shooting mats (one per firing lane),
- Safety glasses / goggles (10 pairs),
- Stopwatch, and
- Pen / pencil.



Additional resources required for specific marksmanship activities may be found in the Attachments.

ACTIVITY LAYOUT

Nil.

ACTIVITY INSTRUCTIONS

1. Brief cadets on the safety rules or any other guidelines pertaining to the activity.
2. Divide the cadets into relays according to the number of firing lanes.
3. Conduct a recreational marksmanship activity, choosing from the following categories:
 - a. classification (located at Attachment A),
 - b. fun activities (located at Attachments B–E),
 - c. timed activities (located at Attachments F–H), or
 - d. competitive team / individual activities (located at Attachments I–J).



If EO C306.03 (Fire the Cadet Air Rifle From the Standing Position) has been taught prior to this marksmanship activity, this EO may be conducted in the standing position.

SAFETY

Range activities will be conducted IAW A-CR-CCP-177/PT-001, *Canadian Cadet Movement: Cadet Marksmanship Program Reference Manual*.

CONFIRMATION OF TEACHING POINT 1

The cadets' participation in the activity will serve as the confirmation of this TP.

END OF LESSON CONFIRMATION

The cadets' participation in the recreational marksmanship activity will serve as the confirmation of this lesson.

CONCLUSION

HOMEWORK / READING / PRACTICE

Nil.

METHOD OF EVALUATION

Nil.

CLOSING STATEMENT

Marksmanship is a fun and exciting activity that requires personal discipline and teamwork skills. This activity has also developed into highly competitive levels at the provincial, regional, and national levels.

INSTRUCTOR NOTES / REMARKS

Hand-washing stations must be available for cleanup after the activity is completed.

Cadets may fire in the standing position if they have received the training associated with EO C306.03 (Fire the Cadet Air Rifle From the Standing Position).

Corps choosing to instruct EO C406.01 (Assist the Range Safety Officer) should allow cadets to fill these roles during air rifle marksmanship activities.

This activity provides opportunities for cadets to complete a leadership assignment as outlined in PO 403 (Act as a Team Leader).

REFERENCES

A0-027 A-CR-CCP-177/PT-001 Director Cadets 3. (2005). *Canadian cadet movement: Cadet marksmanship program reference manual*. Ottawa, ON: Department of National Defence.

A0-041 CATO 14-41 Director Cadets 4. (2007). *Marksmanship, rifles and ammunition*. Ottawa ON: Department of National Defence.

CLASSIFICATION ACTIVITY

CLASSIFICATION ACTIVITY

Objective: To provide cadets the opportunity to obtain marksmanship classifications.

Scoring: The standard for the classification levels are:

1. Marksman: Two five-round groupings within a circle of 3 cm in diameter.
2. First Class Marksman: Two five-round groupings within a circle of 2.5 cm in diameter.
3. Expert Marksman: Two five-round groupings within a circle of 2 cm in diameter.
4. Distinguished Marksman: Two five-round groupings within a circle of 1.5 cm in diameter.

Equipment Required:

Mandatory:

- CCT200GRTD Canadian Cadet Movement Air Rifle Grouping Target (one per cadet), and
- Air Rifle Grouping Template from *Canadian Cadet Movement: Cadet Marksmanship Program Reference Manual* (p. B1-1).

Optional aids to firing are limited to the following:

- Cadet air rifle sling,
- Marksmanship jacket,
- Shooting glove, and
- Hat.

Activity Instructions:

1. Distribute an Air Rifle Grouping Target to each cadet.
2. Have the cadets write their name and date on the target and attach it to the target frame.
3. Give the cadets five pellets to fire into the centre of the target.
4. Have the cadets fire, in relays, following the commands given by the RSO.
5. Give the cadets 15 minutes to complete firing.
6. Have the cadets retrieve their targets.
7. Score the targets using the Air Rifle Grouping Template.
8. Record the scores and allow the cadets to keep their targets.

The following are prohibited:

- Alterations made to the rifles,
- A pellet-loading clip,
- Supports used as a rest for the rifle or the forearm,

- A spotting scope,
- Use of sights not provided with the cadet air rifle, and
- Coaching.

FUN ACTIVITIES

PYRAMID

Objective: To fire pellets into each point on the pyramid.

Scoring: One point is awarded for each point on the pyramid that is hit by a pellet.

Equipment Required:

Mandatory: Pyramid Target (one per cadet).

Optional aids to firing are limited to the following:

- Cadet air rifle sling,
- Marksmanship jacket,
- Shooting glove, and
- Hat.

Activity Instructions:

1. Distribute one Pyramid Target to each cadet.
2. Have the cadets write their name and date on the target and attach it to the target frame.
3. Give the cadets three pellets to fire, one pellet into each corner of the pyramid.
4. Have the cadets fire, in relays, following the commands given by the RSO.
5. Give the cadets three minutes to complete firing.
6. Score the targets awarding one point for each corner hit on the pyramid.
7. Allow the cadets to review and keep their targets.

The following are prohibited:

- Alterations made to the rifles,
- A pellet-loading clip,
- Supports used as a rest for the rifle or the forearm,
- A spotting scope, and
- Use of sights not provided with the cadet air rifle.

PYRAMID TARGET

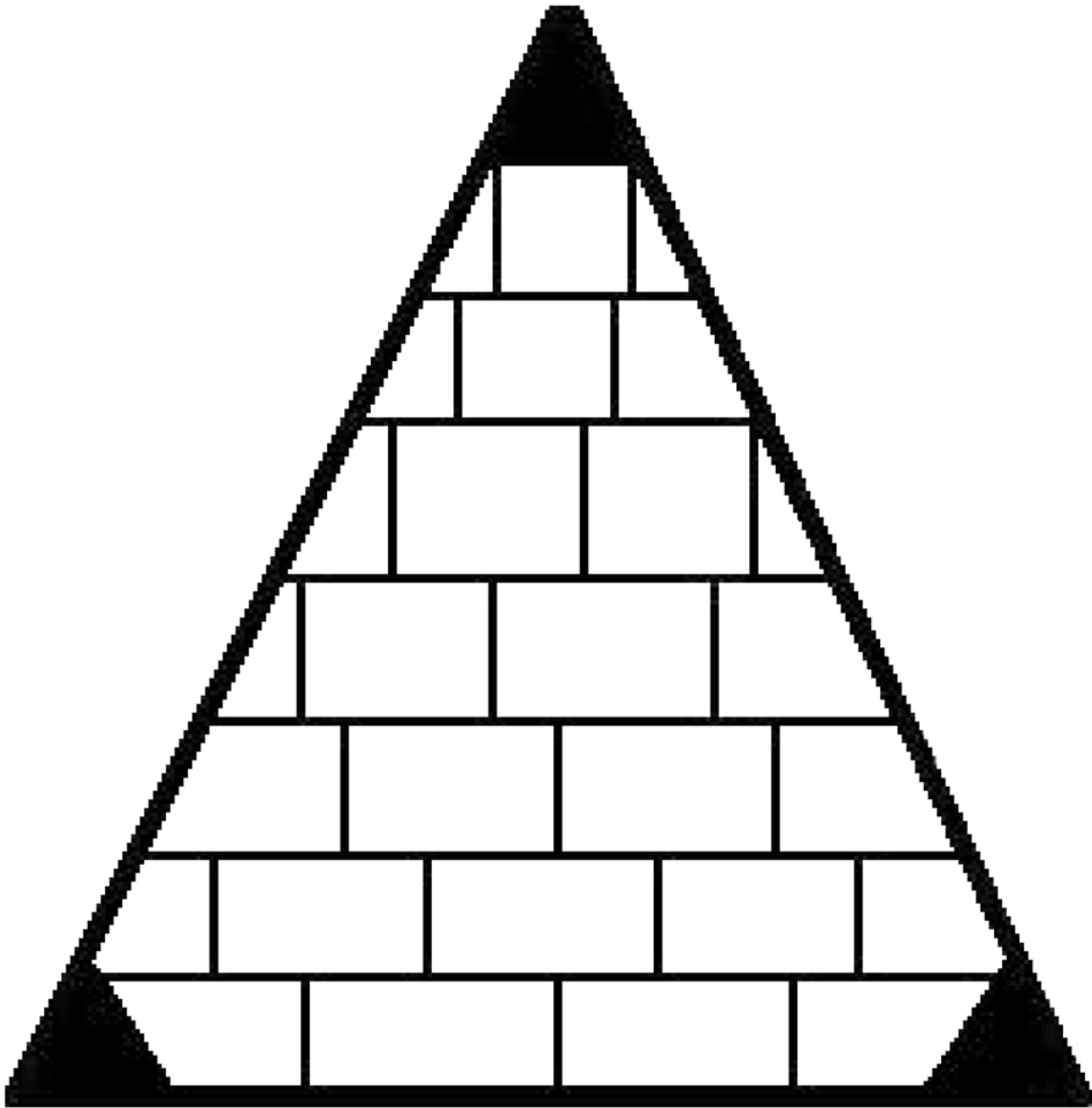

Figure B-1 Pyramid Target

Note. Created by Director Cadets 3, 2007, Ottawa, ON: Department of National Defence.

Name: _____ Date: _____

FUN ACTIVITIES

SHOOTING STAR

Objective: To fire a pellet into each point on the star.

Scoring: One point is awarded for each point on the star that is hit by a pellet.

Equipment Required:

Mandatory: Star Target (one per cadet).

Optional aids to firing are limited to the following:

- Cadet air rifle sling,
- Marksmanship jacket,
- Shooting glove, and
- Hat.

Activity Instructions:

1. Distribute one Star Target to each cadet.
2. Have the cadets write their name and date on the target and attach it to the target frame.
3. Give the cadets five pellets to fire, one pellet into each point on the star.
4. Have the cadets fire, in relays, following the commands given by the RSO.
5. Give the cadets five minutes to complete firing.
6. Score the targets awarding one point for a pellet hit within each point on the star.
7. Allow the cadets to review and keep their targets.

The following are prohibited:

- Alterations made to the rifles,
- A pellet-loading clip,
- Supports used as a rest for the rifle or the forearm,
- A spotting scope, and
- Use of sights not provided with the cadet air rifle.

STAR TARGET



Figure C-1 Star Target

Note. Created by Director Cadets 3, 2007, Ottawa, ON: Department of National Defence.

Name: _____ Date: _____

FUN ACTIVITIES

BEACH BALL

Objective: To fire 10 pellets into the black circle on the beach ball.

Scoring: One point is awarded for each successful hit in the black circle.

Equipment Required:

Mandatory: Beach Ball Target (one per cadet).

Optional aids to firing are limited to the following:

- Cadet air rifle sling,
- Marksmanship jacket,
- Shooting glove, and
- Hat.

Activity Instructions

1. Distribute one Beach Ball Target to each cadet.
2. Have the cadets write their name and date on the target and attach it to the target frame.
3. Give the cadets 10 pellets to fire into the black circle of the beach ball.
4. Have the cadets fire, in relays, following the commands given by the RSO.
5. Give the cadets 10 minutes to complete firing.
6. Score the targets awarding one point for each pellet hit within the black circle.
7. Allow the cadets to review and keep their targets.

The following are prohibited:

- Alterations made to the rifles,
- A pellet-loading clip,
- Supports used as a rest for the rifle or the forearm,
- A spotting scope, and
- Use of sights not provided with the cadet air rifle.

BEACH BALL TARGET



Figure D-1 Beach Ball Target

Note. Created by Director Cadets 3, 2006, Ottawa, ON: Department of National Defence.

Name: _____ Date: _____

FUN ACTIVITIES

BALLOONS

Objective: To fire pellets into balloons on the target.

Scoring: One point is awarded for each balloon hit by a pellet.

Equipment Required:

Mandatory: Balloon Target (one per cadet).

Optional aids to firing are limited to the following:

- Cadet air rifle sling,
- Marksmanship jacket,
- Shooting glove, and
- Hat.

Activity Instructions:

1. Distribute one Balloon Target to each cadet.
2. Have the cadets write their name and date on the target and attach it to the target frame.
3. Give the cadets five pellets to fire, one pellet into each balloon.
4. Have the cadets fire, in relays, following the commands given by the RSO.
5. Give the cadets five minutes to complete firing.
6. Score the targets awarding one point for each balloon hit.
7. Allow the cadets to review and keep their targets.

The following are prohibited:

- Alterations made to the rifles,
- A pellet-loading clip,
- Supports used as a rest for the rifle or the forearm,
- A spotting scope, and
- Use of sights not provided with the cadet air rifle.

Note: Actual balloons may be used in place of the paper targets.

BALLOON TARGET

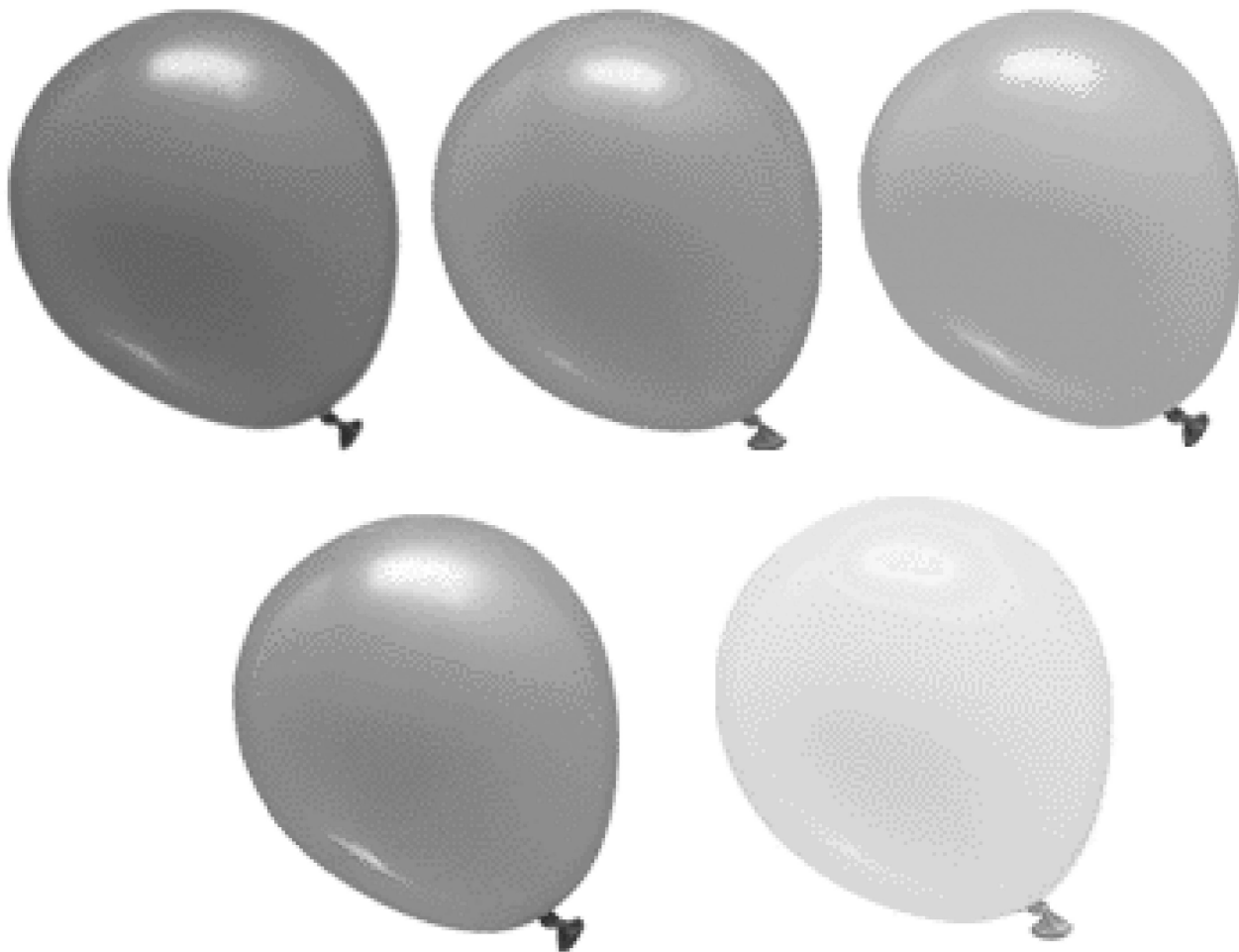

Figure E-1 Balloon Target

Note. Created by Director Cadets 3, 2007, Ottawa, ON: Department of National Defence.

Name: _____ Date: _____

TIMED ACTIVITIES

CHASE THE DOTS

Objective: To fire pellets into the dots on the target in a clockwise direction, within a time limit.

Scoring: One point is awarded for each black dot that is hit by a pellet within the time allotted.

Equipment Required:

Mandatory: Chase the Dots Target (one per cadet).

Optional aids to firing are limited to the following:

- Cadet air rifle sling,
- Marksmanship jacket,
- Shooting glove, and
- Hat.

Activity Instructions:

1. Distribute one Chase the Dots Target to each cadet.
2. Have the cadets write their name and date on the target and attach it to the target frame.
3. Give the cadets eight pellets to fire, one pellet into each black dot, in a clockwise direction.
4. Have the cadets fire, in relays, following the commands given by the RSO.
5. Give the cadets eight minutes to complete firing.
6. Score the targets awarding one point for each black dot hit.
7. Allow the cadets to review and keep their targets.

The following are prohibited:

- Alterations made to the rifles,
- A pellet-loading clip,
- Supports used as a rest for the rifle or the forearm,
- A spotting scope,
- Use of sights not provided with the cadet air rifle, and
- Coaching.

Note: To make this activity more challenging, shorten the time allowance.

CHASE THE DOTS TARGET

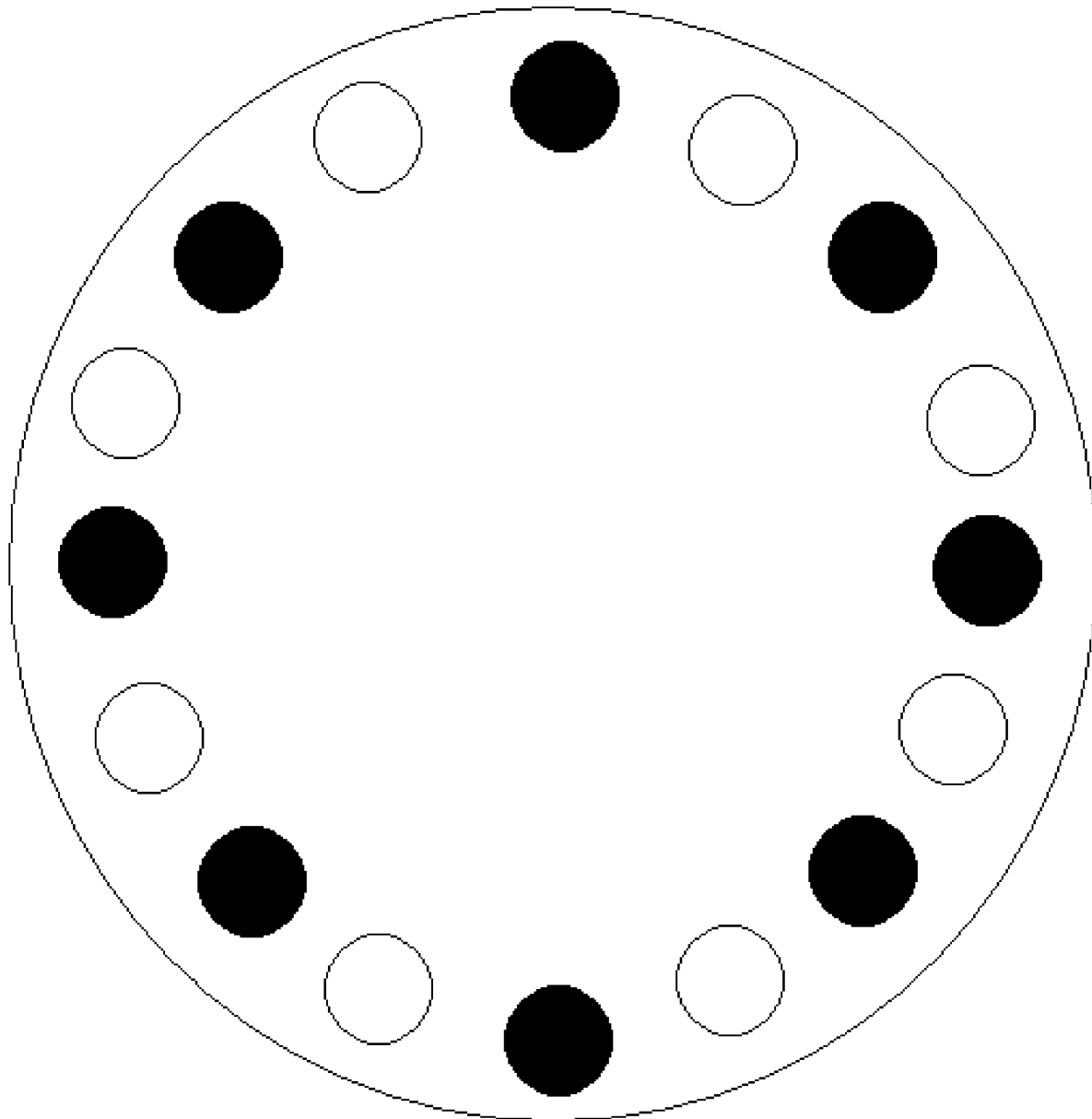

Figure F-1 Chase the Dots Target

Note. Created by Director Cadets 3, 2007, Ottawa, ON: Department of National Defence.

Name: _____ Date: _____

TIMED ACTIVITIES

SPEED GRID

Objective: To fire pellets into the circles on the target, within a time limit.

Scoring: One point is awarded for each circle that is hit by a pellet within the time allotted.

Equipment Required:

Mandatory:

- Cadet air rifle five-pellet clip (three per firing lane), and
- Speed Grid Target (one per cadet).

Optional aids to firing are limited to the following:

- Cadet air rifle sling,
- Marksmanship jacket,
- Shooting glove, and
- Hat.

Activity Instructions:

1. Distribute one Speed Grid Target to each cadet.
2. Have the cadets write their name and date on the target and attach it to the target frame.
3. Give the cadets 15 pellets, pre-loaded into three five-pellet clips.
4. Have the cadets fire one pellet into each circle on the target.
5. Have the cadets fire, in relays, following the commands given by the RSO.
6. Give the cadets 15 minutes to complete firing.
7. Score the targets awarding one point for each circle hit.
8. Allow the cadets to review and keep their targets.

The following are prohibited:

- Alterations made to the rifles,
- Supports used as a rest for the rifle or the forearm,
- A spotting scope,
- Use of sights not provided with the cadet air rifle, and
- Coaching.

Note: To make this activity more challenging, shorten the time allowance.

SPEED GRID TARGET

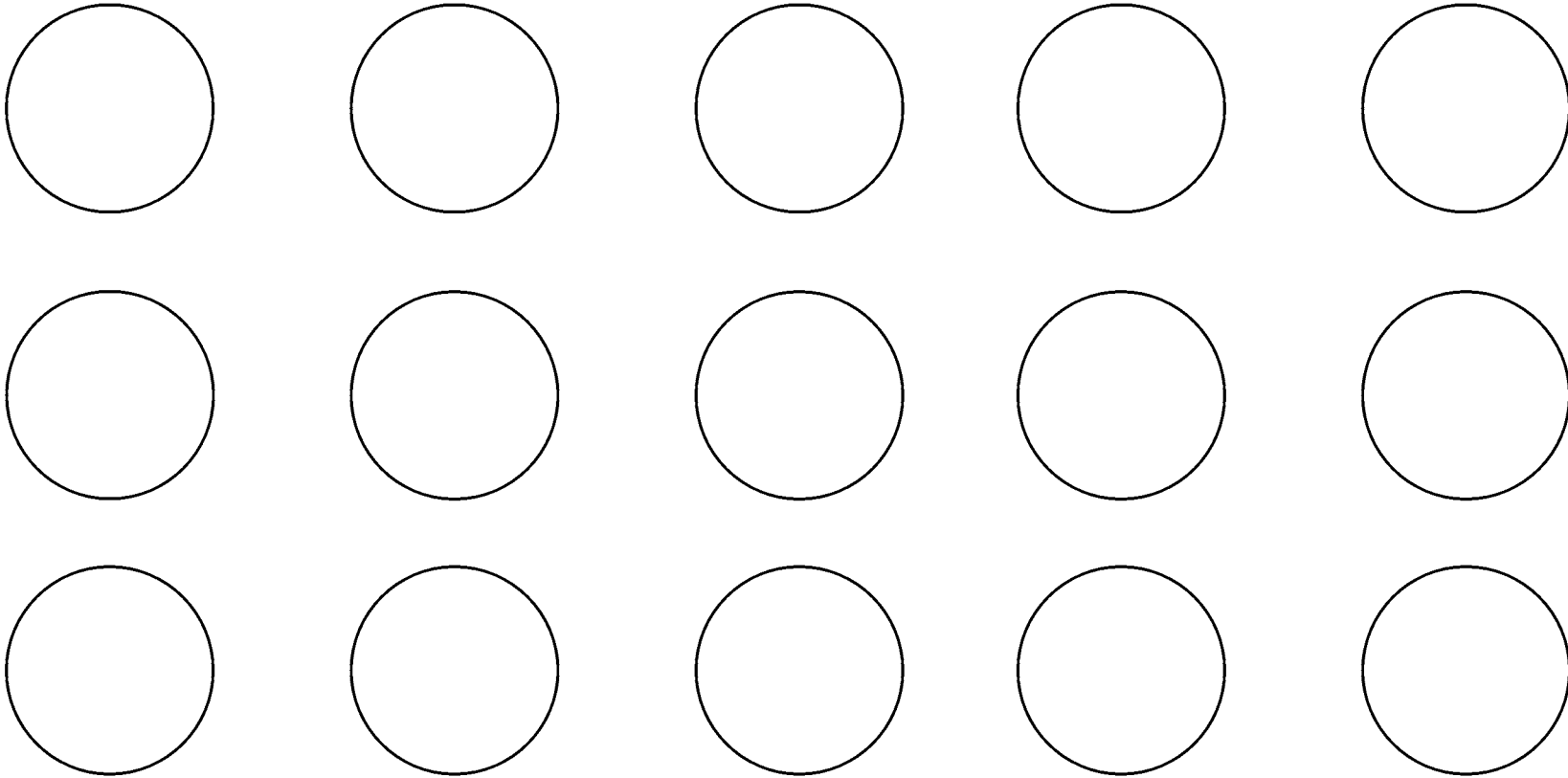

Figure G-1 Speed Grid Target

Note. Created by Director Cadets 3, 2007, Ottawa, ON: Department of National Defence.

Name: _____ Date: _____

TIMED ACTIVITIES

BEAT THE CLOCK

Objective: To fire pellets into the designated hours (numbers) within a time limit.

Scoring: One point is awarded for each correct hour (number) hit by a pellet within the time allotted.

Equipment Required:

Mandatory: Beat the Clock Target (one per cadet).

Optional aids to firing are limited to the following:

- Cadet air rifle sling,
- Marksmanship jacket,
- Shooting glove, and
- Hat.

Activity Instructions:

1. Distribute one Beat the Clock Target to each cadet.
2. Have the cadets write their name and date on the target and attach it to the target frame.
3. Have the cadets fire, in relays, following the commands given by the RSO.
4. Have the RSO using the clock, call out one number every 20 second for a total of six numbers.
5. Give the cadets six pellets to fire, one pellet at each hour (number) as it is called.
6. Score the targets awarding one point for each correct number hit on the target.
7. Allow the cadets to review and keep their targets.

The following are prohibited:

- Alterations made to the rifles,
- Supports used as a rest for the rifle or the forearm,
- A spotting scope,
- Use of sights not provided with the cadet air rifle, and
- Coaching.

Note: To make this activity more challenging, shorten the time allowance.

BEAT THE CLOCK TARGET

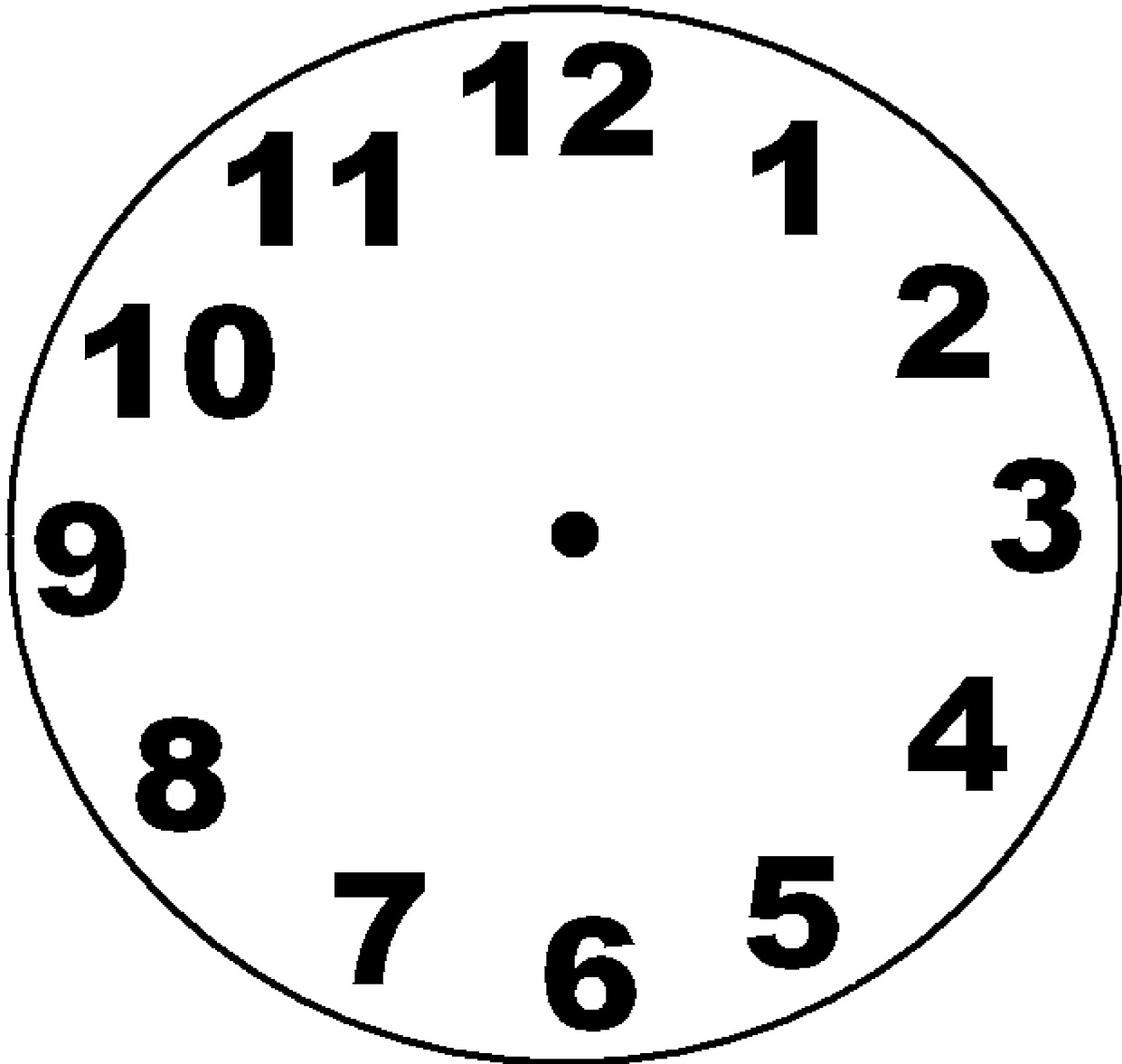

Figure H-1 Clock Target

Note. Created by Director Cadets 3, 2007, Ottawa, ON: Department of National Defence.

Name: _____ Date: _____

COMPETITIVE ACTIVITIES

CORPS MARKSMANSHIP COMPETITION

Objective: To provide cadets the opportunity to compete within the corps.

Scoring: Targets will be scored IAW A-CR-CCP-177/PT-001, *Canadian Cadet Movement: Cadet Marksmanship Program Reference Manual*, to include:

- Each target has a highest possible score of 100 points (10 diagrams worth 10 points each).
- All shot holes are scored using the highest value of the scoring ring that it is broken.
- Shots outside the scoring rings are given a value of zero.
- If more than the one pellet is fired on a target, the shots with the highest value will be discarded until one shot remains on the target. Also, a two-point penalty will be applied to each excess shot.
- If more than one shot is fired at a scoring diagram, only the prescribed number of shots may be fired at the remaining diagrams (eg, if two shots were fired at the first diagram, one diagram on the target would remain blank [free of shots]). If this occurs more than twice, a two-point penalty will be applied to each excess shot.
- This activity may be conducted as individuals or teams of four.

Equipment Required:

Mandatory: CCT2001AR853 CCM Competition Targets (two per cadet).

Optional aids to firing are limited to the following:

- Cadet air rifle sling,
- Marksmanship jacket,
- Shooting glove, and
- Hat.

Activity Instructions:

1. Distribute two CCT2001AR853 CCM Competition Targets to each cadet.
2. Have the cadets write their name and date on each target and attach them to the target frame.
3. Give the cadets 20 scoring pellets to fire, one pellet at each scoring diagram (additional zeroing pellets are permitted).
4. Have the cadets fire, in relays, following the commands given by the RSO.
5. Give the cadets 30 minutes to complete firing.
6. Have the RSO collect the targets, score as described above and record the results.
7. Allow the cadets to review and keep their targets.

The following are prohibited:

- Crossfiring,
- Alterations made to the rifles,

- Supports used as a rest for the rifle or the forearm,
- A spotting scope, and
- Use of sights not provided with the cadet air rifle.

COMPETITIVE ACTIVITIES

LUNAR LAUNCH

Objective: To provide cadets the opportunity to compete within the corps.

Scoring: The average distance from the earth to the moon is 384 400 km. All targets from marksmanship activities conducted during marksmanship training will be added together to calculate a distance from Earth and achieve a position on the space shuttle crew. The four scoring levels / positions must meet the following standards:

- | | | | |
|----|---------------------|----------------------|---------------------------------------|
| 1. | Mission Commander: | A score of 100 plus: | 384 400 km from earth, lunar landing! |
| 2. | Mission Specialist: | A score of 75 to 99: | 288 300 km from earth. |
| 3. | Chief Engineer: | A score of 50 to 74: | 192 200 km from earth. |
| 4. | Science Officer: | A score of 25 to 49: | 96 100 km from earth, lunar launch! |

Equipment Required:

Mandatory: Scores for all targets used in marksmanship activities during the training year.

Activity Instructions:

1. Add the scores from the targets used by each cadet during the training year.
2. Use the scoring method described above to assign the cadets levels / positions on the space shuttle crew.

Notes:

1. A record must be kept of each cadet's scores from all marksmanship activities.
2. This activity may be conducted over multiple training years.
3. The certificate found at Attachment J may be awarded to cadets who achieve levels / positions in this activity.

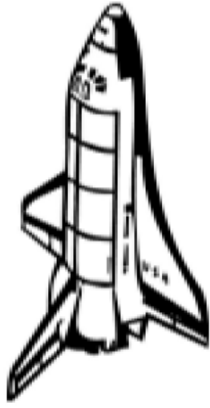

This is to certify that

has achieved the position of

in the



Lunar Launch Marksmanship Activity

Date

Range Safety Officer



**COMMON TRAINING
GOLD STAR
INSTRUCTIONAL GUIDE**



SECTION 2

EO C406.01 – ASSIST THE RANGE SAFETY OFFICER (RSO)

Total Time:

30 min

PREPARATION

PRE-LESSON INSTRUCTIONS

Resources needed for the delivery of this lesson are listed in the lesson specification located in A-CR-CCP-704/PG-001, *Gold Star Qualification Standard and Plan*, Chapter 4. Specific uses for said resources are identified throughout the instructional guide within the TP for which they are required.

Review the lesson content and become familiar with the material prior to delivering the lesson.

PRE-LESSON ASSIGNMENT

Photocopy, distribute and have each cadet read the Ways to Assist the RSO handout located at Attachment A a minimum of one week prior to delivering the lesson.

APPROACH

A group discussion was chosen for this lesson as it allows the cadets to interact with their peers and share their knowledge, experiences, opinions, and feelings about assisting the RSO. Sharing in the discussion encourages the cadet to examine their own thoughts and feelings and may prompt them to re-examine their previously held ideas. Participating in a group discussion improves the cadet's listening skills and team development.

INTRODUCTION

REVIEW

Nil.

OBJECTIVES

By the end of this lesson the cadet shall be expected to assist the RSO on an air rifle range.

IMPORTANCE

It is important for cadets to have knowledge of how to assist the Range Safety Officer (RSO) on the range. In order to assist the RSO, cadets must know how to set up and dismantle an air rifle range, control pellets, perform the duties of a range sentry, and score targets.

Teaching Point 1**Discuss ways to assist the RSO.**

Time: 25 min

Method: Group Discussion

BACKGROUND KNOWLEDGE



The point of the group discussion is to draw the following information from the group using the tips for answering / facilitating discussion and the suggested questions provided.

SETTING UP AN AIR RIFLE RANGE

Once the required air rifle range equipment has been collected and the cadet air rifles have been inspected, the equipment can be set up. The specific details of an air rifle range layout may vary depending on the type of air rifle range; however, the dimensions and location of the equipment will remain the same. The air rifle range will be set up by:

1. **Posting warning signals.** A sentry should be posted at access points if they cannot be permanently blocked (eg, a door to a gymnasium that does not have a lock).
2. **Setting up equipment at the backstop.** At one end of the room, the target frames will be set up in front of a wall. Care should be taken to avoid using a wall with windows or other items (eg, light switch, fire alarm, smoke detector) that would be damaged by a stray pellet. If this is unavoidable, a plywood covering should be placed over those items. The front of the target frame must be perpendicular to the floor and aligned with the front of other target frames along a target line. Additional lighting may be required for the target during some competition activities to satisfy competition rules. Lighting will not interfere with the cadets' view of the target frame.
3. **Indicating firing lanes.** Target frames will be centred in a lane at least 1.25 m wide and extend away from the target line toward the firing point a distance of 10 m. 10 m from the target line, another line will be marked on the floor. This is the firing line and no person will move forward of it without permission from the RSO.
4. **Placing equipment at the firing point.** Behind the firing line is the firing box, an area at least 1.25 m wide by 2.5 m deep. A firing box will be allocated for each firer. A shooting mat will be placed within the firing box aligned with the firing line (during standing position firing no mat is required). Safety glasses / goggles will be placed on every shooting mat. An area behind the firing box will be allocated for range staff.
5. **Placing equipment behind the firing point.** The area behind the firing point contains the table(s) required to set up a pellet distribution point, scoring area or other workspace as required for the specific air rifle marksmanship activity being conducted. The first aid point with stretcher is located in this area and must be clearly identified. The handwashing facility may be located on the range behind the firing point or in a washroom within the building.
6. **Placing the cadet air rifle at the firing point.** A cadet air rifle with cadet air rifle safety rod will be the last item placed on the air rifle range. When removing the cadet air rifle from the case, control the muzzle by carrying the cadet air rifle in a vertical position with a cadet air rifle safety rod inserted into the barrel. Once the cadet air rifle is placed on the firing point, the cadet air rifle safety rod may be removed.

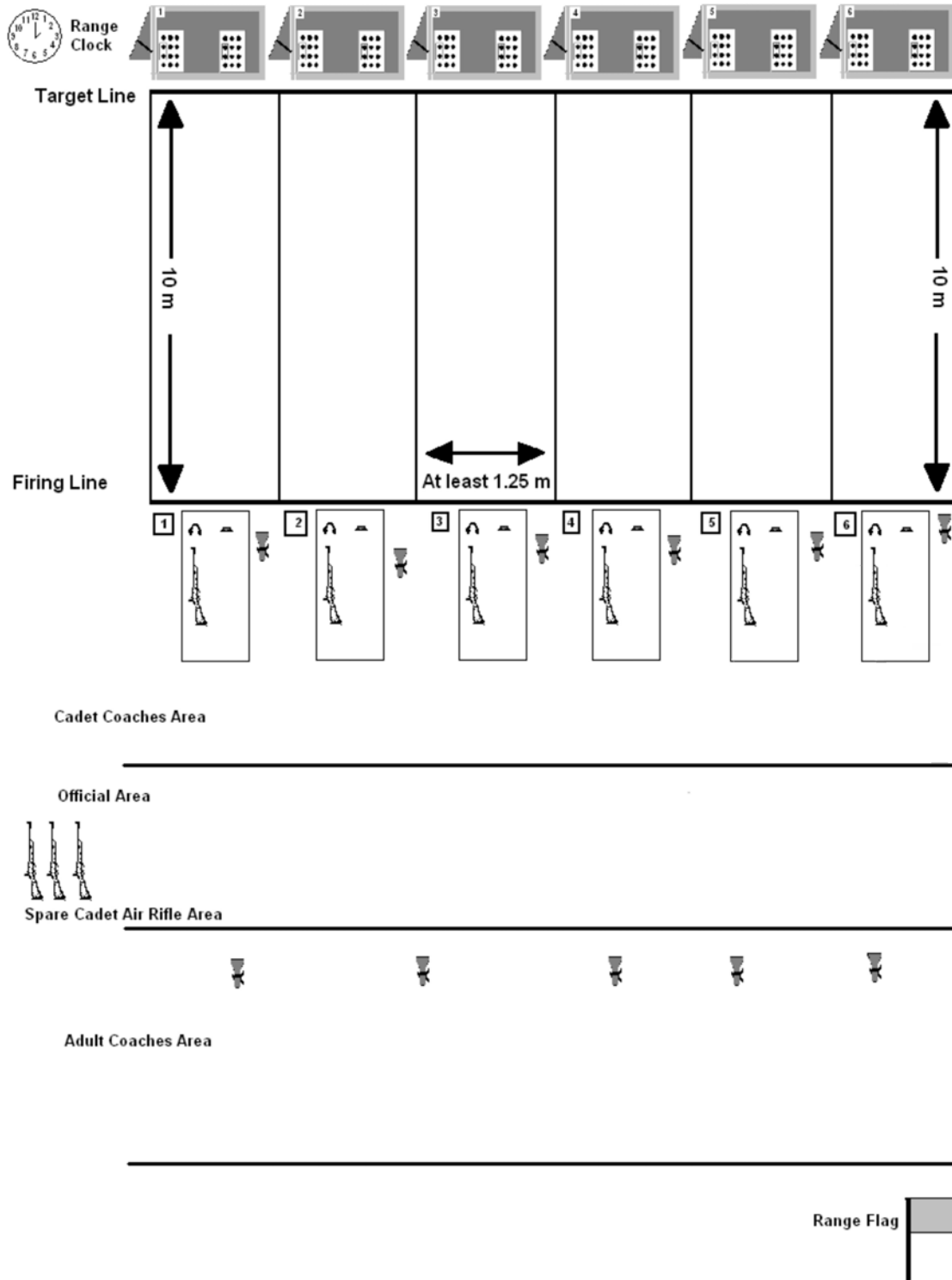

Figure 1 Cadet Air Rifle Range

Note. Created by D Cds 3, 2007, Ottawa, ON: Department of National Defence.

DISMANTLING AN AIR RIFLE RANGE

Once the air rifle marksmanship activity has been completed, the air rifle range can be dismantled. The air rifle range will be dismantled by:

1. **Storing the cadet air rifle.** After an air rifle marksmanship activity, the cadet air rifle is the first piece of range equipment secured. A cadet air rifle safety rod is inserted into the barrel before the cadet air rifle is moved from the firing point. Cadet air rifles are securely stored at the unit according to current policy guidelines.



For detailed storage requirements for the cadet air rifle refer to NDSI 65, *Storage and Transportation of Rifles for Canadian Rangers, Cadets and Junior Canadian Rangers*.

2. **Storing the equipment behind the firing point.** Equipment used behind the firing point is stored next. Equipment must be cleaned (if required) and stored to prevent damage. If the first aid kit has been used, it may require refilling.
3. **Storing the equipment at the firing point.** Equipment used at the firing point is stored next. Equipment must be cleaned (if required) and stored to prevent damage. Care should be taken to minimize scratching of safety glasses / goggles. Shooting mats are folded or rolled properly to minimize rips or tears. Spotting scopes are stored in their cases (if applicable).
4. **Cleaning the backstop area.** Once the firing point equipment has been secured, the target frames are thoroughly emptied of spent pellets. The target holder is cleaned of any material (eg, targets, thumbtacks, staples) and the target frame is folded and stored.
5. **Cleaning the firing lanes.** Since lead dust in the air is a minor hazard to safety, a method of sweeping / mopping that reduces the amount of dust produced should be used. One set of cleaning gear is used after air rifle marksmanship activities to limit cross-contamination of other areas of the building.
6. **Removing the warning signals.** Once all other air rifle marksmanship equipment has been secured, the range warning signals are removed. This will indicate that the room in which the temporary indoor range was set up is now cleaned and ready for general use.

PELLET CONTROLLER

During an air rifle marksmanship activity, cadets may be appointed to assist the RSO by acting as a pellet controller. The duties of a pellet controller include:

- **Maintain possession of pellets at all times.** Pellets are placed in the possession of the pellet controller. They ensure the pellets are secured at all times by means of direct supervision.
- **Distribute pellets.** Depending on the specific type of air rifle marksmanship activity being conducted, the pellet controller counts pellets into containers that will be placed on the firing point upon the RSO's command.
- **Dispose of pellets.** Once the air rifle marksmanship activity is concluded, the pellet controller ensures that the area around the target frame is swept. The spent pellets are collected into a container for disposal by the RSO.



Since pellets are made of lead, a hazardous material, they must be disposed IAW local standing orders.

- **Record the number of pellets used during the activity.** As the activity proceeds, the pellet controller tracks the number of pellets being used during each relay. Once the activity is complete, the total number of pellets used can be calculated. Any additional pellets given by the RSO / range assistants to cadets during the activity (eg, misfires, deformed pellets) are added to the total. This information is used by the RSO to track the quantity of pellets available at the unit.



The need to record the number of pellets used at a corps / squadron / CSTC may or may not be regionally directed. In the case where no requirement exists, it is still an effective tool for the RSO and a practical leadership opportunity for the cadets acting as pellet controllers.

- **Record the number of pellets used for each rifle.** The Cadet Air Rifle Usage Log shows the RSO when one thousand pellets have been fired by each cadet air rifle. When one thousand pellets have been fired the cadet air rifle requires cleaning. The pellet controller records the total number of pellets used in each cadet air rifle during the air rifle activity.



The Cadet Air Rifle Usage Log was developed as a practical leadership opportunity for cadets to be given added responsibility while they act as a pellet controller.

RANGE SENTRY

A range sentry is responsible, during the course of firing, to restrict entry on to the range and for changing warning signals when instructed to do so by the RSO. They must be able to constantly communicate with the RSO to report any safety concerns.

Restrict Access to the Range During Firing

On most indoor temporary ranges, access points exist and must be secured during the course of firing. By posting a range sentry outside an access point, the RSO can be assured no one can access the range and be struck by pellets. On outdoor ranges, roads leading to the range may need to be blocked and a range sentry posted to control vehicle access. In a situation where the range sentry is unable to directly attract the attention of the RSO, a means of communication such as a hand-held radio may be required.

Control Range Warning Signals

Range sentries are responsible for controlling the range warning signals. At the commencement of an air rifle marksmanship activity, a green flag / light / signal shall be posted to alert people that the range is in use but no live firing is currently in progress. The location of warning signals vary based on the local specifications of the air rifle range being used. Typically, warning signals are posted at the backstop, firing point and on access roads leading to the range.

For indoor ranges, warning signals are posted at entranceways to the room in which the range is set up. On the command of the RSO, the range sentry changes the green warning signal to red. The red signal alerts people that the range is in use and live firing is in progress. The red warning signal is posted from before the course of fire begins until the RSO has cleared the last cadet air rifle of the relay. At this time, on the command of the RSO,

the range sentry changes the warning signal back to green. At the conclusion of the air rifle marksmanship activity, all warning signals are removed to indicate that the range is no longer in use.

Notify the RSO of Safety Concerns Inside / Outside the Range Area

During the conduct of an air rifle marksmanship activity, the range sentry is responsible for bringing safety concerns both on and off the range area to the attention of the RSO. These concerns may include wildlife entering the range or visitors requesting access to the range.

FIRING POINT ASSISTANT

A firing point assistant is appointed by the RSO; usually to a specific number of firing points (eg, firing points 1–4). Their main responsibility is to ensure that the firers are carrying out the RSO's commands safely and correctly.

Supervise Firers Responding to Range Commands

As the RSO gives commands, the firing point assistant observes the firers to ensure they respond correctly. Each cadet should know exactly what to do when given a command on the range. When a cadet does not perform the given command, the firing point assistant will move to the cadet's firing point to ensure they are capable of firing on the range and assist where necessary. If safety is a concern, the RSO should be notified as soon as possible.

Assist Firers as Necessary

Some cadets may require assistance throughout the firing practice (eg, pumping the cadet air rifle, tightening their sling). The firing point assistant will look for opportunities where assistance is required, and help out the cadets as necessary.

Correct Errors

When errors are made, the firing point assistant will correct them immediately. To correct an error, the assistant will explain what was done wrong, demonstrate how to perform it correctly (if able to do so) and observe the cadet perform.

Notify the RSO of Safety Concerns

Any safety concerns observed on the range shall be brought to the attention of the RSO immediately.

TARGET SCORER

The target scorer is responsible for scoring targets once they have been fired. Once a target has been scored, the score is recorded directly on the target. In some cases, an RSO may require the scores to be recorded on a spreadsheet or separate piece of paper.



The process for scoring targets is detailed in EO C406.02 (Score Air Rifle Marksmanship Targets).

There are two official targets used for air rifle marksmanship activities: the CCM Air Rifle Grouping Target (CCT2000GRTD) and the CCM Competition Target (CCT2001AR853). There are various targets used in fun and timed air rifle marksmanship activities. These other targets are reproduced locally and can be found attached to the activity's applicable instructional guide.

GROUP DISCUSSION



TIPS FOR ANSWERING / FACILITATING DISCUSSION:

- Establish ground rules for discussion, eg, everyone should listen respectfully; don't interrupt; only one person speaks at a time; no one's ideas should be made fun of; you can disagree with ideas but not with the person; try to understand others as much as you hope they understand you; etc.
- Sit the group in a circle, making sure all cadets can be seen by everyone else.
- Ask questions that will provoke thought; in other words avoid questions with yes or no answers.
- Manage time by ensuring the cadets stay on topic.
- Listen and respond in a way that indicates you have heard and understood the cadet. This can be done by paraphrasing their ideas.
- Give the cadets time to respond to your questions.
- Ensure every cadet has an opportunity to participate. One option is to go around the group and have each cadet answer the question with a short answer. Cadets must also have the option to pass if they wish.
- Additional questions should be prepared ahead of time.

SUGGESTED QUESTIONS:

- Q1. What are some of the ways to assist an RSO?
- Q2. What are the dimensions of a firing lane?
- Q3. What will be the last piece of equipment placed on the air rifle range?
- Q4. What method of cleaning should be used to clean the firing lanes on an indoor temporary air rifle range?
- Q5. What are the five duties of a pellet controller?
- Q6. How must pellets be disposed?
- Q7. What is one benefit of tracking how many pellets were fired during an air rifle activity?
- Q8. What are the responsibilities of a range sentry?
- Q9. Why is it important to restrict access points to the air rifle range?
- Q10. What does a red warning signal indicate?
- Q11. What are the duties of a firing point assistant?
- Q12. What are some occasions on the range in which the firing point assistant can assist the firers?
- Q13. When a cadet is making an error, how should it be corrected?
- Q14. Once a target is scored, where is the value recorded?
- Q15. What are the two official targets used for air rifle marksmanship activities?



Other questions and answers will develop throughout the group discussion. The group discussion should not be limited to only those suggested.



Reinforce those answers given and comments made during the group discussion, ensuring the teaching point has been covered.

CONFIRMATION OF TEACHING POINT 1

The cadets' participation in the group discussion will serve as the confirmation of this TP.

END OF LESSON CONFIRMATION

The cadets' participation in the group discussion will serve as the confirmation of this lesson.

CONCLUSION

HOMEWORK / READING / PRACTICE

Nil.

METHOD OF EVALUATION

Nil.

CLOSING STATEMENT

There will be many opportunities to assist the RSO when completing marksmanship activities. Knowing how to set up and dismantle an air rifle range, enforce safety, control pellets, assist on the firing point and score targets are critical duties that have to be completed whenever completing air rifle marksmanship activities. The ways to assist an RSO produce a variety of leadership opportunities.

INSTRUCTOR NOTES / REMARKS

Cadets will assist the RSO during marksmanship activities, specifically EO M406.01 (Participate in a Recreational Marksmanship Activity) and EO C106.01 (Participate in a Recreational Marksmanship Activity).

REFERENCES

A0-027 A-CR-CCP-177/PT-001 Director Cadets 3. (2005). *Cadet marksmanship program: Reference manual*. Ottawa, ON: Department of National Defence.

A0-041 CATO 14-41 Director Cadets 4. (2009). *Authorized rifle training*. Ottawa, ON: Department of National Defence.

WAYS TO ASSIST THE RSO

SET UP AN AIR RIFLE RANGE

Once the required air rifle range equipment has been collected and the cadet air rifles have been inspected, the equipment can be set up. The specific details of an air rifle range layout may vary depending on the type of air rifle range; however, the dimensions and location of the equipment will remain the same. The air rifle range will be set up by:

1. **Posting warning signals.** A sentry should be posted at access points if they cannot be permanently blocked (eg, a door to a gymnasium that does not have a lock).
2. **Setting up equipment at the backstop.** At one end of the room, the target frames will be set up in front of a wall. Care should be taken to avoid using a wall with windows or other items (eg, light switch, fire alarm, smoke detector) that would be damaged by a stray pellet. If this is unavoidable, a plywood covering should be placed over those items. The front of the target frame must be perpendicular to the floor and aligned with the front of other target frames along a target line. Additional lighting may be required for the target during some competition activities to satisfy competition rules. Lighting will not interfere with the cadets' view of the target frame.
3. **Indicating firing lanes.** Target frames will be centred in a lane at least 1.25 m wide and extend away from the target line toward the firing point a distance of 10 m. 10 m from the target line, another line will be marked on the floor. This is the firing line and no person will move forward of it without permission from the RSO.
4. **Placing equipment at the firing point.** Behind the firing line is the firing box, an area at least 1.25 m wide by 2.5 m deep. A firing box will be allocated for each firer. A shooting mat will be placed within the firing box aligned with the firing line (during standing position firing no mat is required). Safety glasses / goggles will be placed on every shooting mat. An area behind the firing box will be allocated for range staff.
5. **Placing equipment behind the firing point.** The area behind the firing point contains the table(s) required to set up a pellet distribution point, scoring area or other workspace as required for the specific air rifle marksmanship activity being conducted. The first aid point with stretcher is located in this area and must be clearly identified. The handwashing facility may be located on the range behind the firing point or in a washroom within the building.
6. **Placing the cadet air rifle at the firing point.** A cadet air rifle with cadet air rifle safety rod will be the last item placed on the air rifle range. When removing the cadet air rifle from the case, control the muzzle by carrying the cadet air rifle in a vertical position with a cadet air rifle safety rod inserted into the barrel. Once the cadet air rifle is placed on the firing point, the cadet air rifle safety rod may be removed.

DISMANTLE AN AIR RIFLE RANGE

Once the air rifle marksmanship activity has been completed, the air rifle range can be dismantled. The air rifle range will be dismantled by:

1. **Storing the cadet air rifle.** After an air rifle marksmanship activity, the cadet air rifle is the first piece of range equipment secured. A cadet air rifle safety rod is inserted into the barrel before the cadet air rifle is moved from the firing point. Cadet air rifles are securely stored at the unit according to current policy guidelines.
2. **Storing the equipment behind the firing point.** Equipment used behind the firing point is stored next. Equipment must be cleaned (if required) and stored to prevent damage. If the first aid kit has been used, it may require refilling.

3. **Storing the equipment at the firing point.** Equipment used at the firing point is stored next. Equipment must be cleaned (if required) and stored to prevent damage. Care should be taken to minimize scratching of safety glasses / goggles. Shooting mats are folded or rolled properly to minimize rips or tears. Spotting scopes are stored in their cases (if applicable).
4. **Cleaning the backstop area.** Once the firing point equipment has been secured, the target frames are thoroughly emptied of spent pellets. The target holder is cleaned of any material (eg, targets, thumbtacks, staples) and the target frame is folded and stored.
5. **Cleaning the firing lanes.** Since lead dust in the air is a minor hazard to safety, a method of sweeping / mopping that reduces the amount of dust produced should be used. One set of cleaning gear is used after air rifle marksmanship activities to limit cross-contamination of other areas of the building.
6. **Removing the warning signals.** Once all other air rifle marksmanship equipment has been secured, the range warning signals are removed. This will indicate that the room in which the temporary indoor range was set up is now cleaned and ready for general use.

PELLET CONTROLLER

During an air rifle marksmanship activity, cadets may be appointed to assist the RSO by acting as a pellet controller. The duties of a pellet controller include:

- **Maintain possession of pellets at all times.** Pellets are placed in the possession of the pellet controller. They ensure the pellets are secured at all times by means of direct supervision.
- **Distribute pellets.** Depending on the specific type of air rifle marksmanship activity being conducted, the pellet controller counts pellets into containers that will be placed on the firing point upon the RSO's command.
- **Dispose of pellets.** Once the air rifle marksmanship activity is concluded, the pellet controller ensures that the area around the target frame is swept. The spent pellets are collected into a container for disposal by the RSO.
- **Record the number of pellets used during the activity.** As the activity proceeds, the pellet controller tracks the number of pellets being used during each relay. Once the activity is complete, the total number of pellets used can be calculated. Any additional pellets given by the RSO / range assistants to cadets during the activity (eg, misfires, deformed pellets) are added to the total. This information is used by the RSO to track the quantity of pellets available at the unit.
- **Record the number of pellets used for each rifle.** The Cadet Air Rifle Usage Log shows the RSO when one thousand pellets have been fired by each cadet air rifle. When one thousand pellets have been fired the cadet air rifle requires cleaning. The pellet controller records the total number of pellets used in each cadet air rifle during the air rifle activity.

RANGE SENTRY

A range sentry is responsible, during the course of firing, to restrict entry on to the range and for changing warning signals when instructed to do so by the RSO. They must be able to constantly communicate with the RSO to report any safety concerns.

Restrict Access to the Range During Firing

On most indoor temporary ranges, access points exist and must be secured during the course of firing. By posting a range sentry outside an access point, the RSO can be assured no one can access the range and be struck by pellets. On outdoor ranges, roads leading to the range may need to be blocked and a range sentry

posted to control vehicle access. In a situation where the range sentry is unable to directly attract the attention of the RSO, a means of communication such as a hand-held radio may be required.

Control Range Warning Signals

Range sentries are responsible for controlling the range warning signals. At the commencement of an air rifle marksmanship activity, a green flag / light / signal shall be posted to alert people that the range is in use but no live firing is currently in progress. The location of warning signals vary based on the local specifications of the air rifle range being used. Typically, warning signals are posted at the backstop, firing point and on access roads leading to the range.

For indoor ranges, warning signals are posted at entranceways to the room in which the range is set up. On the command of the RSO, the range sentry changes the green warning signal to red. The red signal alerts people that the range is in use and live firing is in progress. The red warning signal is posted from before the course of fire begins until the RSO has cleared the last cadet air rifle of the relay. At this time, on the command of the RSO, the range sentry changes the warning signal back to green. At the conclusion of the air rifle marksmanship activity, all warning signals are removed to indicate that the range is no longer in use.

Notify the RSO of Safety Concerns Inside / Outside the Range Area

During the conduct of an air rifle marksmanship activity, the range sentry is responsible for bringing safety concerns both on and off the range area to the attention of the RSO. These concerns may include wildlife entering the range or visitors requesting access to the range.

FIRING POINT ASSISTANT

A firing point assistant is appointed by the RSO; usually to a specific number of firing points (eg, firing points 1–4). Their main responsibility is to ensure that the firers are carrying out the RSO's commands safely and correctly.

Supervise Firers Responding to Range Commands

As the RSO gives commands, the firing point assistant observes the firers to ensure they respond correctly. Each cadet should know exactly what to do when given a command on the range. When a cadet does not perform the given command, the firing point assistant will move to the cadets firing point to ensure they are capable of firing on the range and assist where necessary. If safety is a concern, notify the RSO as soon as possible.

Assist Firers as Necessary

Some cadets may require assistance throughout the firing practice (eg, pumping the cadet air rifle, tightening their sling). The firing point assistant will look for opportunities where assistance is required, and help out the cadets as necessary.

Correct Errors

When errors are made, the firing point assistant will correct them immediately. To correct an error, explain what was done wrong, demonstrate how to perform it correctly (if able to do so) and observe the cadet perform.

Notify the RSO of Safety Concerns

Any safety concerns observed on the range shall be brought to the attention of the RSO immediately.

TARGET SCORER

The target scorer is responsible for scoring targets once they have been fired. Once a target has been scored, the score is recorded directly on the target. In some cases, an RSO may require the scores to be recorded on a spreadsheet or separate piece of paper.

There are two official targets used for air rifle marksmanship activities: the CCM Air Rifle Grouping Target (CCT2000GRTD) and the CCM Competition Target (CCT2001AR853). There are various targets used in fun and timed air rifle marksmanship activities. These other targets are reproduced locally and can be found attached to the activity's applicable instructional guide.



**COMMON TRAINING
GOLD STAR
INSTRUCTIONAL GUIDE**



SECTION 3

EO C406.02 – SCORE AIR RIFLE MARKSMANSHIP TARGETS

Total Time: 30 min

PREPARATION

PRE-LESSON INSTRUCTIONS

Resources needed for the delivery of this lesson are listed in the lesson specification located in A-CR-CCP-704/PG-001, *Gold Star Qualification Standard and Plan*, Chapter 4. Specific uses for said resources are identified throughout the instructional guide within the TP for which they are required.

Review the lesson content and become familiar with the material prior to delivering the lesson.

Photocopy the Sample Grouping Target handout located at Attachment A for each cadet.

Photocopy the Sample Competition Target handout located at Attachment C for each cadet.

Prepare slides of the Air Rifle Grouping Template and Scoring Template found at Attachments B and D for each cadet.

PRE-LESSON ASSIGNMENT

Nil.

APPROACH

An interactive lecture was chosen for TP 1 to orient the cadets to the targets used during air rifle marksmanship activities and to generate interest.

A demonstration and performance was chosen for TPs 2 and 3 as it allows the instructor to explain and demonstrate scoring grouping and competition targets while providing an opportunity for the cadets to practice under supervision.

INTRODUCTION

REVIEW

Nil.

OBJECTIVES

By the end of this lesson the cadet shall be expected to score the CCM Air Rifle Grouping Target and the CCM Competition Target.

IMPORTANCE

It is important for cadets to score air rifle marksmanship targets as it provides a skill that will be used when they assist a Range Safety Officer (RSO). Being able to determine the score on a target will allow the cadet to monitor their progress as they improve in applying the principles of marksmanship.

Teaching Point 1**Describe air rifle marksmanship targets.**

Time: 5 min

Method: Interactive Lecture

AIR RIFLE MARKSMANSHIP TARGETS

There are two official targets used for air rifle marksmanship activities: the CCM Air Rifle Grouping Target (CCT2000GRTD) and the CCM Competition Target (CCT2001AR853). There are various targets used in fun and timed air rifle marksmanship activities. These other targets are reproduced locally and can be found attached to the activity's applicable instructional guide.

CCM Air Rifle Grouping Target

The CCM Air Rifle Grouping Target is used during classification air rifle marksmanship activities. The target consists of two diagrams. Each diagram is a shaded black circle that is 3 cm in diameter. The diagram itself is provided on the target to give the marksman an aiming mark and thus any grouping fired at each diagram does not necessarily need to be contained on the black portion of the target.

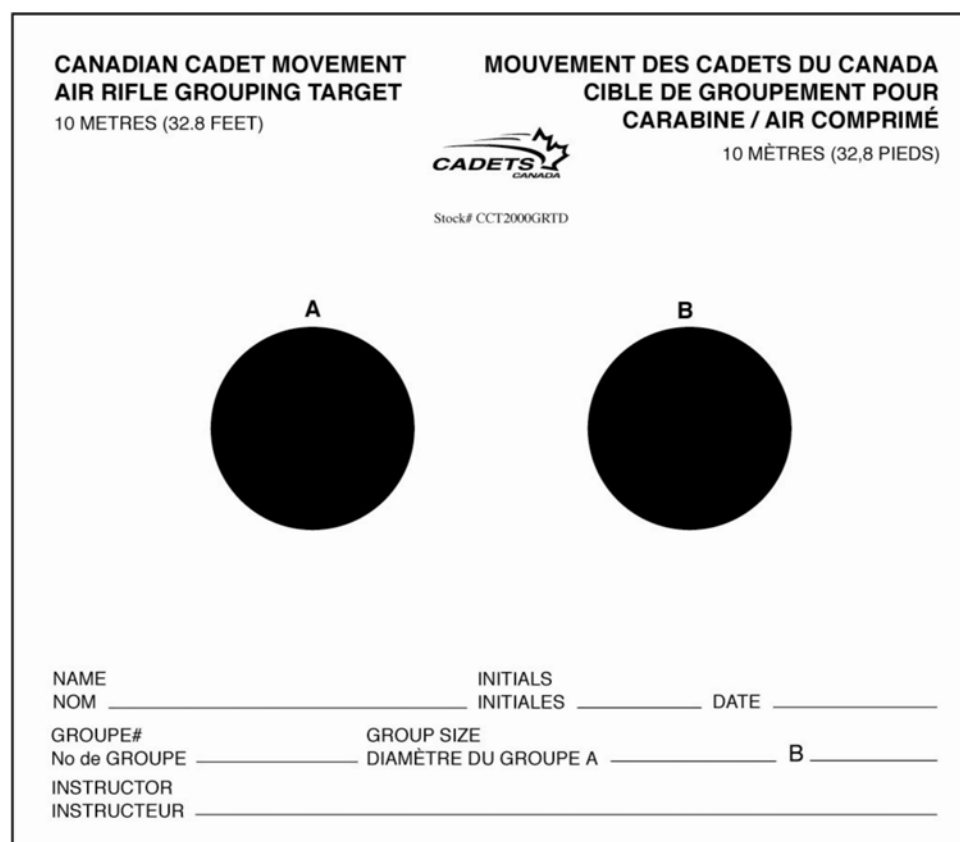

Figure 1 The CCM Air Rifle Grouping Target (CCT2000GRTD)

Note. Created by Director Cadets 4, 2000, Ottawa, ON: Department of National Defence.

CCM Competition Target

The CCM Competition Target, also called an application target, is the official target used in the CCM Marksmanship Championship Series. This target is used only with the cadet air rifle at a distance of 10 m (32.8 ft). The target contains 10 scoring diagrams and two sighting diagrams. Each scoring diagram consists of a 4.5-mm circle (the inner 3 cm of the scoring diagram is shaded black as an aiming mark) broken into

10 concentric scoring rings, scored from ten (the bull's eye) to one (the outer most ring). As there are 10 scoring diagrams, the highest possible score (HPS) is 100. The sighting diagrams, identical to the scoring diagrams and labelled A and B, are used by the firer to confirm zeroing the cadet air rifle during the competition relay.

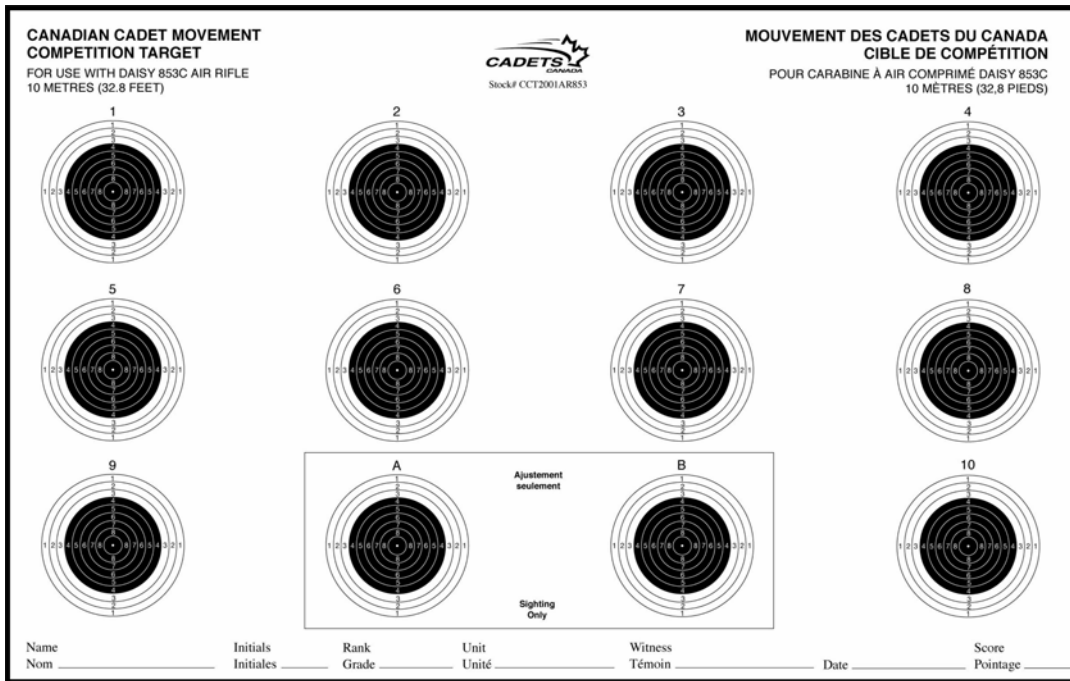



Figure 2 The CCM Competition Target (CCT2001AR853)

Note. Created by Director Cadets 4, 2001, Ottawa, ON: Department of National Defence.

Non-Standard Targets

Non-standard targets are used during fun and timed air rifle marksmanship activities. Non-standard targets are designed to give cadets a break from firing on the two official targets and allow for the development of activities that provide a different style marksmanship experience. Some examples of non-standard targets include the turkey shoot target, beat the clock targets, balloon targets and chase the dot targets. Other non-standard targets may be developed for use during fun and timed air rifle marksmanship activities by the activity leader as required.



Examples of non-standard targets used during fun and timed air rifle marksmanship activities can be found as attachments to EO M406.01 (Participate in a Recreational Marksmanship Activity). These targets are reproduced locally.

CONFIRMATION OF TEACHING POINT 1

QUESTIONS:

- Q1. How many scoring diagrams are there on the CCM Competition Target?
- Q2. What is the HPS on the CCM Competition Target?
- Q3. What are some types of targets used during fun and timed air rifle marksmanship activities?

ANTICIPATED ANSWERS:

- A1. There are 10 scoring diagrams on the CCM Competition Target.
- A2. The HPS on the CCM Competition Target is 100.
- A3. Some targets used during timed air rifle marksmanship targets are beat the clock, speed grid and chase the dots.

Teaching Point 2**Explain, demonstrate and have the cadets score the CCM Air Rifle Grouping Target.**

Time: 10 min

Method: Demonstration and Performance



For this TP it is recommended that the instructor explain and demonstrate each step required to complete the skill then monitor the cadets as they imitate each step.

Note: Assistant instructors may be employed to monitor the cadets' performance.



Provide each cadet with the Sample Grouping Target handouts located at Attachment A and an Air Rifle Grouping Template located at Attachment B.

Air Rifle Grouping Template. The Air Rifle Grouping Template is a series of grouping circles engraved or printed on transparent material. It is used to confirm the diameter of a grouping fired during familiarization or classification firing. The Air Rifle Grouping Template consists of a series of grouping circle outlines, with diameters from 1–6 cm inclusive. It is very important to correctly and consistently measure grouping targets with the grouping template.

SCORING THE CCM AIR RIFLE GROUPING TARGET

Score the CCM Air Rifle Grouping Target using the following procedure:

1. **Determine there are five shots in the grouping.** Before scoring any grouping, the number of shots on the target is determined. If a cadet has not hit the target at least five times for each grouping the score will not count. It is difficult at times to determine when several pellet holes overlap. Observe the outline of the hole for the distinct outline of an arc of a clean pellet hole. This indicates the number of pellets that may have caused the larger hole. The skill level of cadets is also a good indication of how many shots are in a grouping. If a cadet is shooting a larger grouping size, the possibility for two pellets fired exactly through one hole is slim.



Each diagram on the Sample Grouping Target handout contains five shots.

2. **Align the Air Rifle Grouping Template over the five-shot grouping so that all shots are within a scoring ring.** Once the grouping has been confirmed as being made up of five shots, the Air Rifle Grouping Template is placed over the target. The Air Rifle Grouping Template should be aligned so that all the shots fit easily within a grouping circle without touching.



A grouping size of 4 cm will be large enough to serve as a starting point for each diagram on the Sample Grouping Target handout.

3. **Determine if the grouping will fit within the next smallest ring without touching the scoring ring.** Choose the next smallest grouping circle and determine if the group fits within it. The entire group must fit within the grouping circle without touching the inside edge.
4. **Repeat as required until the grouping will not fit within the next smallest scoring ring without touching the scoring ring.**



The correct grouping size for each diagram from the Sample Grouping Target handout is:

- Target 1, Diagram A—3.5 cm,
- Target 1, Diagram B—2.7 cm,
- Target 2, Diagram A—1.8 cm, and
- Target 2, Diagram B—2.5 cm.

5. **Record the grouping size on the target.** The grouping size recorded on the target is the corresponding grouping circle diameter.
6. **Determine the classification category.** Once two groupings have been scored on one grouping target, a determination is made as to the classification category obtained. There are four categories of marksmanship classification.
 - **Marksman:** Each grouping must be within a circle of 3 cm in diameter.
 - **First Class Marksman:** Each grouping must be with a circle of 2.5 cm in diameter.
 - **Expert Marksman:** Each grouping must be within a circle of 2 cm in diameter.
 - **Distinguished Marksman:** Each grouping must be within a circle of 1.5 cm in diameter.

Each marksmanship classification category has a corresponding badge that may be worn on the uniform. The marksmanship classification does not expire and any improvement in the classification category during subsequent classification air rifle activities is reflected with the awarding of the higher category.



From the Sample Grouping Target handout, Target 1 does not meet the requirements for a marksmanship classification category. Target 2 meets the requirements for a First Class Marksman classification category.



Refer to Annex A of CATO 14-43, *Marksmanship Program*, for detailed instructions about the marksmanship classification program.

CONFIRMATION OF TEACHING POINT 2

The cadets' scoring of the Sample Grouping Target handout will serve as the confirmation of this TP.

Teaching Point 3

Explain, demonstrate and have the cadets score the CCM Competition Target.

Time: 10 min

Method: Demonstration and Performance



For this TP it is recommended that the instructor explain and demonstrate each step required to complete the skill then monitor the cadets as they imitate each step.

Note: Assistant instructors may be employed to monitor the cadets' performance.



Divide the cadets into groups based on the number of scoring magnifiers and scoring plugs available. Distribute a Sample Competition Target handout located at Attachment C to each cadet. Distribute a scoring magnifier, scoring plug and Scoring Template found at Attachment D to each group.

SCORING THE CCM COMPETITION TARGET

Score the CCM Competition Target using the following procedure:

1. **Determine the score on each diagram.** Determine the score for each diagram using one or more of the following methods:
 - a. **Determine the value by inspecting with the naked eye.** In most cases the scoring ring that has been broken is easily identifiable. The scoring diagrams on the competition target that can be scored in this manner are scored first as they can be completed in less time.
 - b. **Determine the value using the .177-scoring magnifier.** If the pellet hole has occurred close to the edge of a scoring ring, it is necessary to use the scoring magnifier to enlarge the view and make a determination of value. Look through the magnifying lens and align the scoring magnifier over the pellet hole. If the pellet hole has broken or touched the higher scoring ring, award that value. If even a small gap exists between the pellet hole and the scoring ring the lower value must be awarded.
2. **Calculate penalties.** When scoring a target there are two penalties the scorer can determine and calculate. If a penalty is imposed, the rule number and penalty amount is noted next to the applicable diagram. The following rules are excerpts from the Canadian Cadet Movement Marksmanship Championship Series (CCMMCS).

22.3.4.1 If a Competitor fires more than the prescribed number of shots on the scoring area in a twenty (20) shot string, the shot(s) with the highest value will be discarded until the correct number of shots remain. In addition, a two (2) point Penalty will be deducted for each excess shot.

22.3.4.2 If a Competitor fires more than the prescribed number of shots on a scoring diagram, the Competitor must fire a like number of fewer shots on a subsequent scoring diagram in the same twenty (20) shot string. The Competitor will not be penalized for the first two (2) such occurrences in a Competition, but will be penalized two (2) points for each succeeding occurrence.

Figure 3 Scoring Penalties

Note. From Canadian Cadet Movement: Cadet Marksmanship Program Reference Manual (p. 4-4-31), by Director Cadets 3, 2005, Ottawa, ON: Department of National Defence.

- Record the score on the target.** Once the diagrams are given values and penalties are calculated, the score is totalled and recorded on the target. It is important to ensure the addition of values is accurate since during a competition protests may be filed due to inaccurate calculations.

CONFIRMATION OF TEACHING POINT 3

The cadets' scoring of the Sample Competition Target handout will serve as the confirmation of this TP.

END OF LESSON CONFIRMATION

QUESTIONS:

- Q1. What are the three types of targets used during air rifle marksmanship activities?
- Q2. What size must each grouping be to award a Distinguished Marksman classification category?
- Q3. When scoring targets, how is it determined when to score the higher ring value and when to score the lower ring value?

ANTICIPATED ANSWERS:

- A1. The three types of targets are the CCM Grouping Target, CCM Competition Target and non-standard targets.
- A2. Each grouping must be within a circle of 1.5 cm in diameter.
- A3. If the pellet hole has broken or touched the higher scoring ring, then that higher value must be awarded. If even a small gap exists between the pellet hole and the scoring ring the lower value must be awarded.

CONCLUSION

HOMEWORK / READING / PRACTICE

Nil.

METHOD OF EVALUATION

Nil.

CLOSING STATEMENT

You must be able to score air rifle marksmanship targets to perform your duties when assisting the RSO. Being able to score air rifle marksmanship targets will also allow you to assess your own performance and the performance of others. These skills will allow you to better perform the duties of an Air Rifle Marksmanship Instructor.

INSTRUCTOR NOTES / REMARKS

Nil.

REFERENCES

A0-027 A-CR-CCP-177/PT-001 Director Cadets 3. (2005). *Canadian Cadet Movement: Cadet marksmanship program reference manual*. Ottawa, ON: Department of National Defence.

A0-148 CATO 14-43 Director Cadets 4. (2009). *Marksmanship program*. Ottawa, ON: Department of National Defence.

THIS PAGE INTENTIONALLY LEFT BLANK

SAMPLE GROUPING TARGET

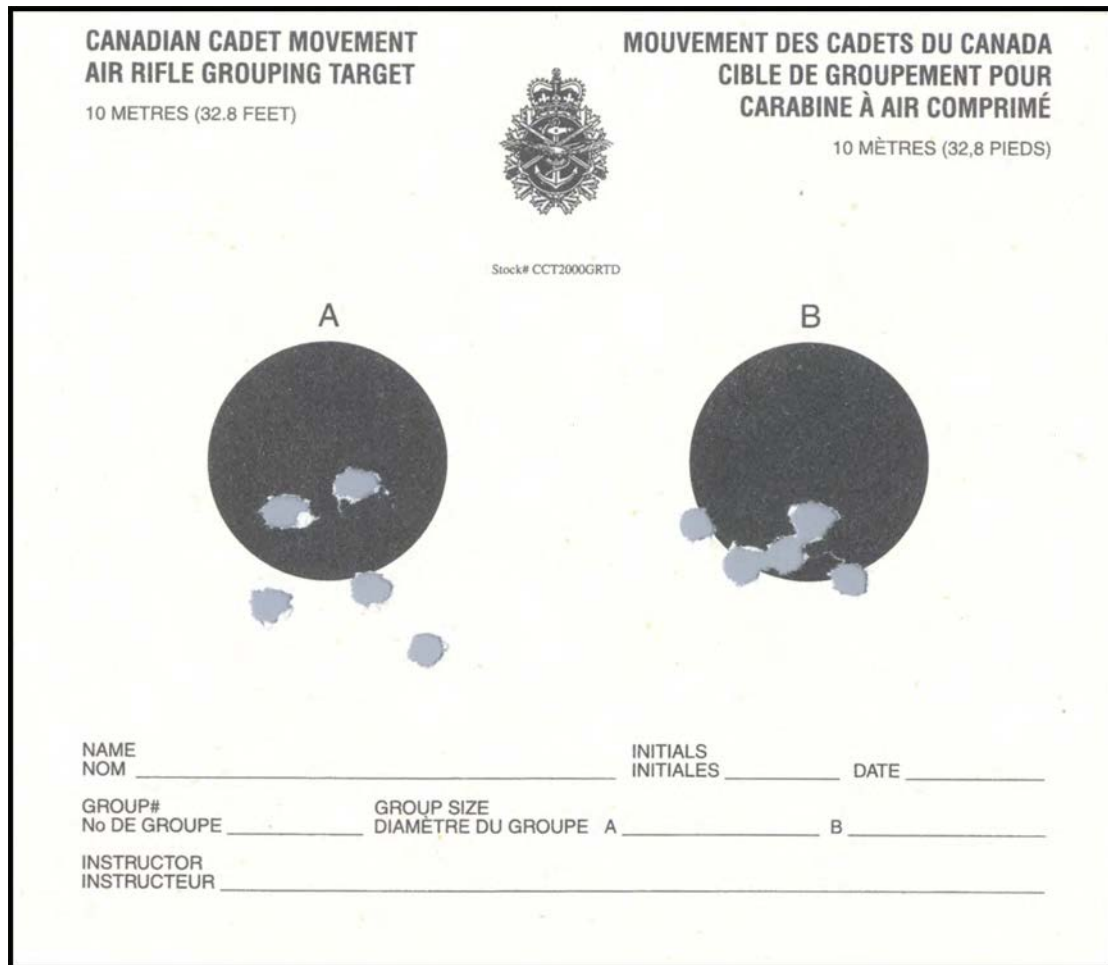

Figure A-1 Target 1

Note. Created by Director Cadets 3, 2009, Ottawa, ON: Department of National Defence.

SAMPLE GROUPING TARGET

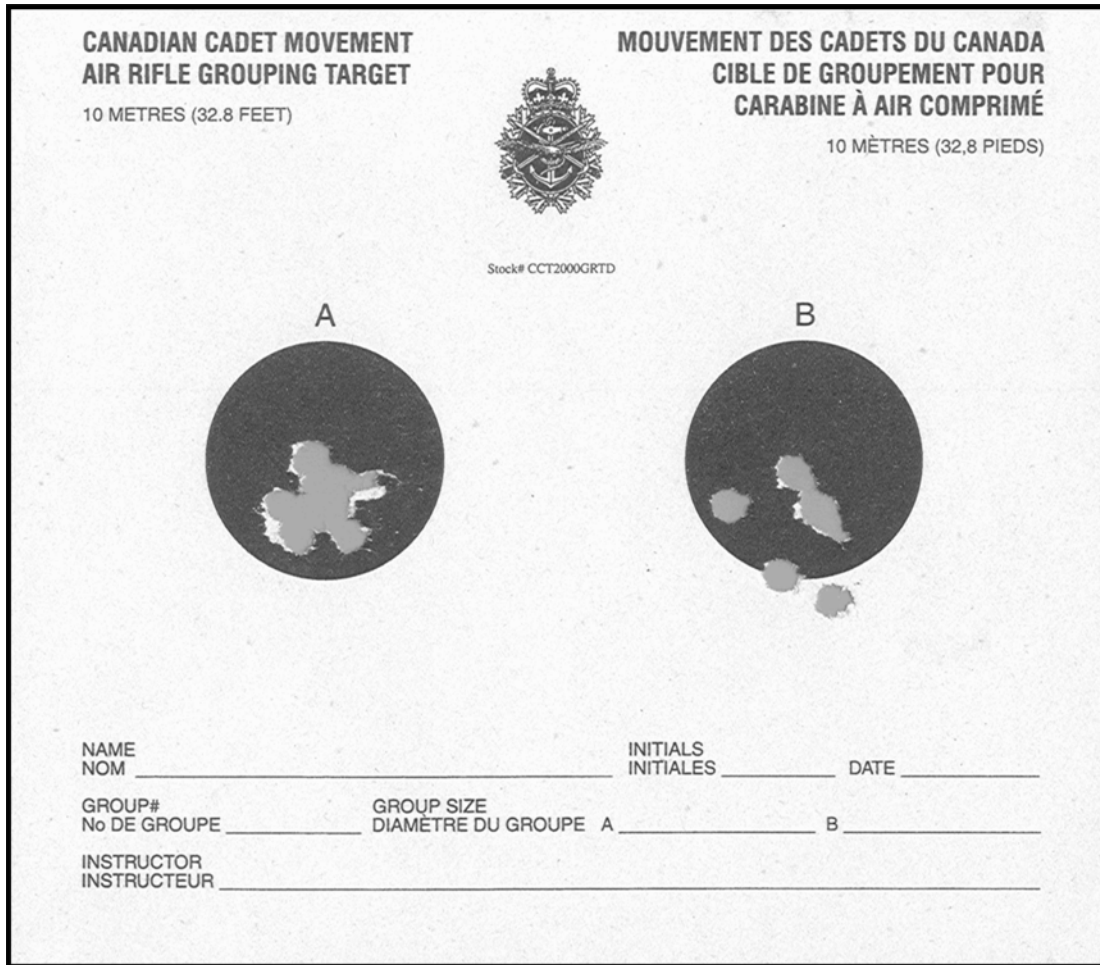

Figure A-2 Target 2

Note. Created by Director Cadets 3, 2009, Ottawa, ON: Department of National Defence.

AIR RIFLE GROUPING TEMPLATE

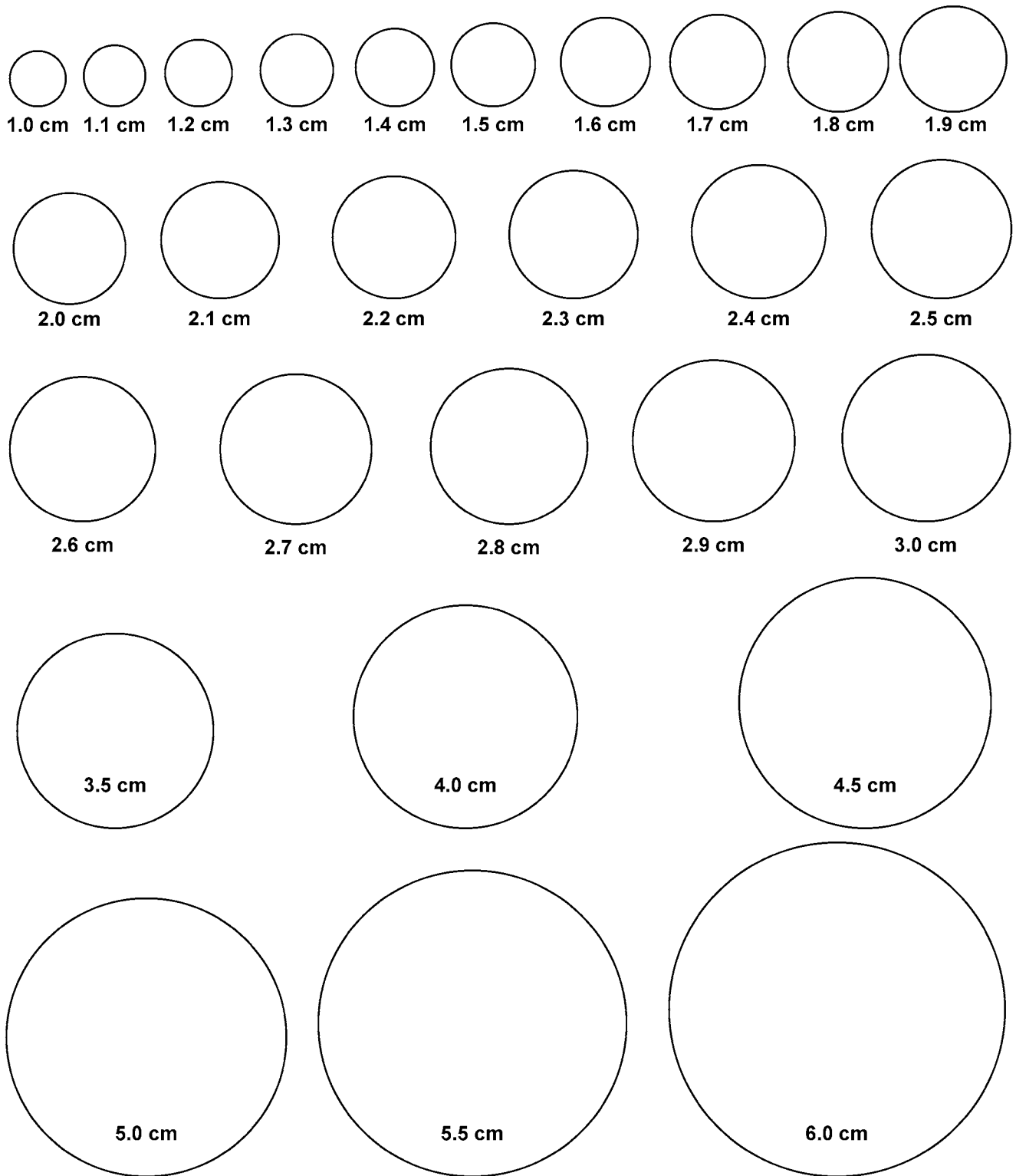

Figure B-1 Air Rifle Grouping Template

Note. Created by Director Cadets 3, 2009, Ottawa, ON: Department of National Defence.

THIS PAGE INTENTIONALLY LEFT BLANK

SAMPLE COMPETITION TARGET

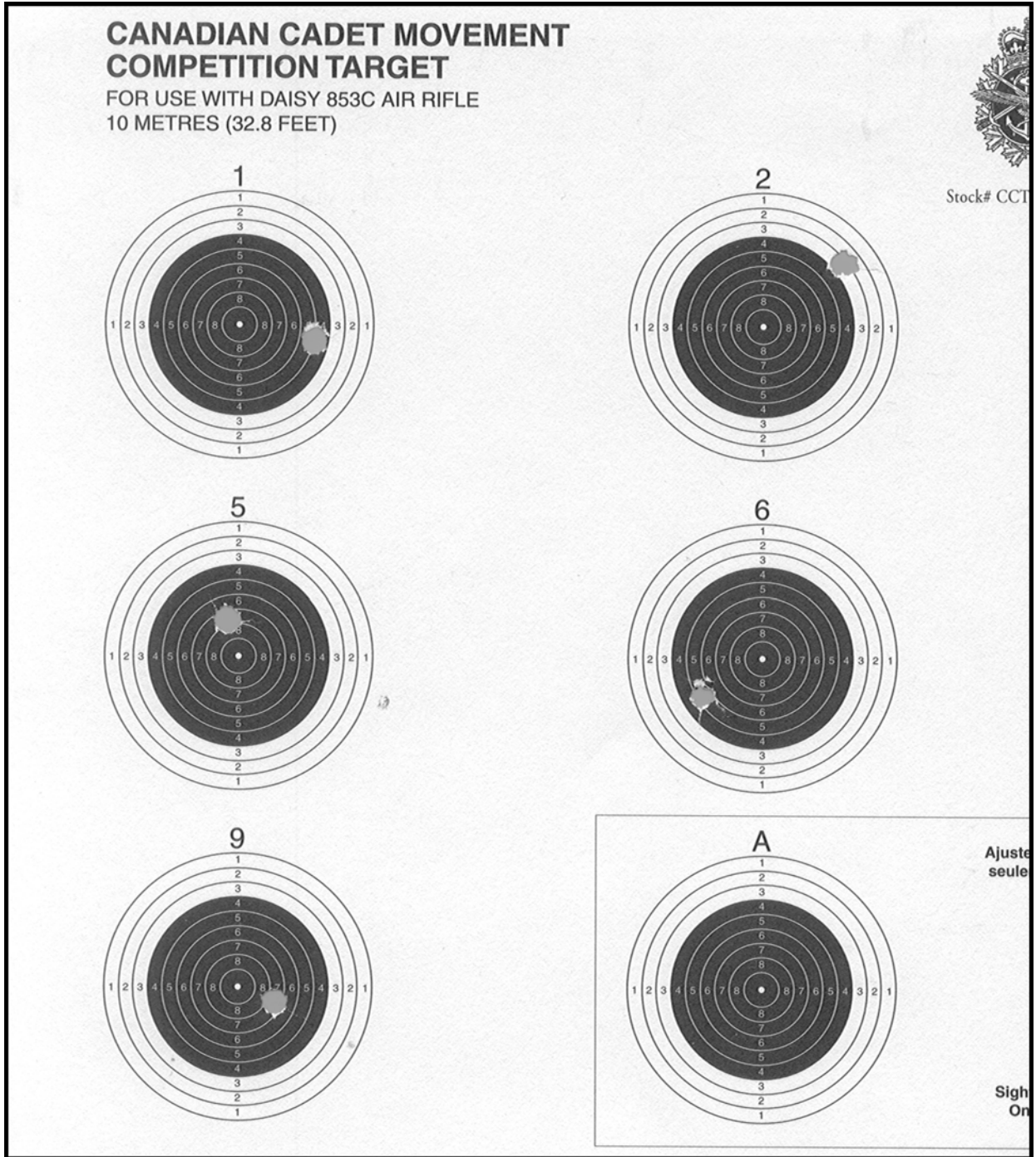

Figure C-1 Target 1 (Left Half)

Note. Created by Director Cadets 3, 2009, Ottawa, ON: Department of National Defence.

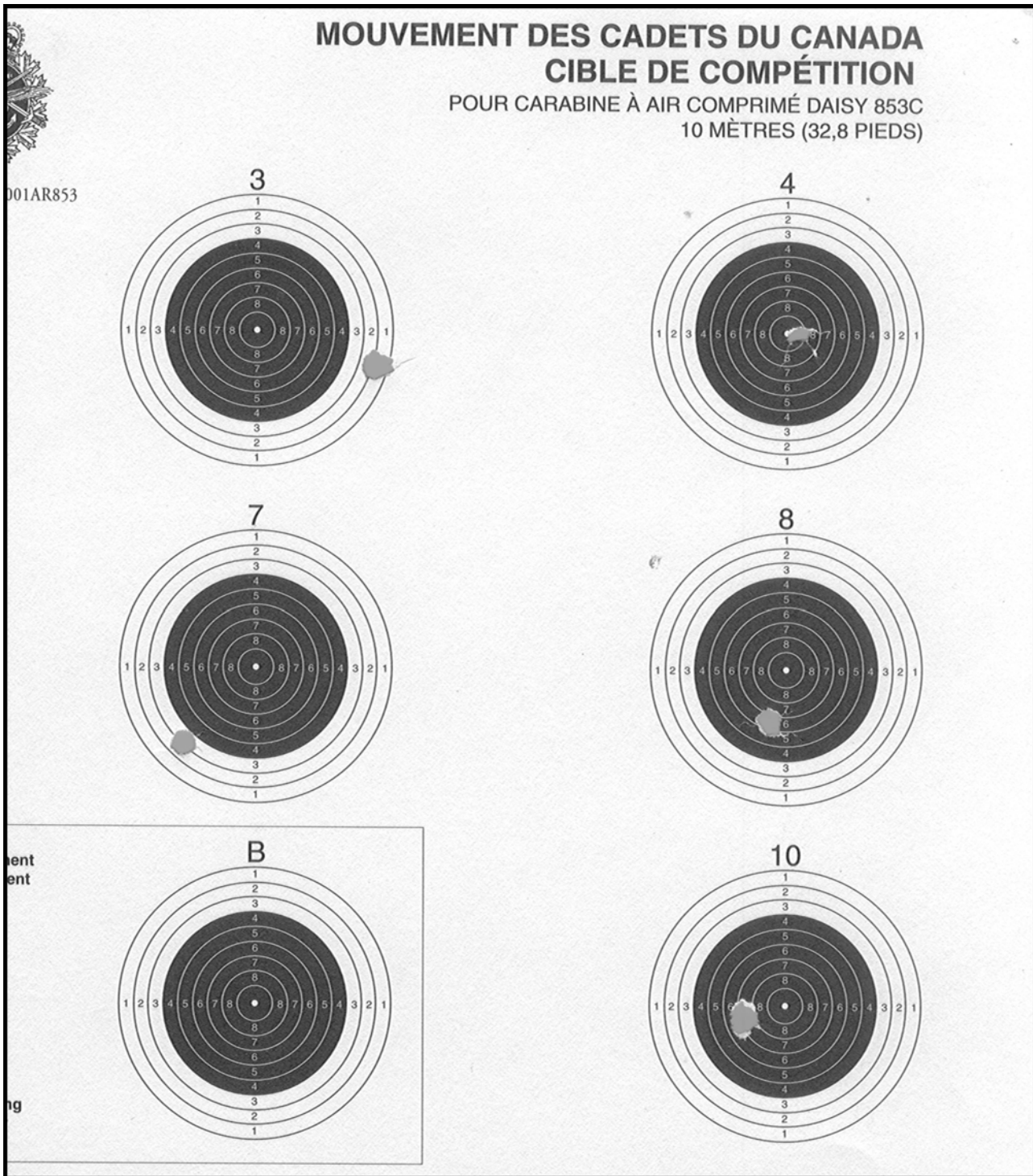

Figure C-2 Target 1 (Right Half)

Note. Created by Director Cadets 3, 2009, Ottawa, ON: Department of National Defence.

SCORING TEMPLATE



Figure D-1 Scoring Template

Note. Created by Director Cadets 3, 2009, Ottawa, ON: Department of National Defence.

THIS PAGE INTENTIONALLY LEFT BLANK



ROYAL CANADIAN ARMY CADETS

GOLD STAR

INSTRUCTIONAL GUIDE



SECTION 1

EO M407.01 – IDENTIFY GOLD STAR TRAINING OPPORTUNITIES

Total Time: 30 min

PREPARATION

PRE-LESSON INSTRUCTIONS

Resources needed for the delivery of this lesson are listed in the lesson specification located in A-CR-CCP-704/PG-001, *Gold Star Qualification Standard and Plan*, Chapter 4. Specific uses for said resources are identified throughout the instructional guide within the TP for which they are required.

Review the lesson content and become familiar with the material prior to delivering the lesson.

Photocopy the Gold Star program training summary and time allocation, located at A-CR-CCP-704/PG-001, *Gold Star Qualification Standard and Plan*, Chapter 2, Annex A, for each cadet.

Obtain a copy of the corps Gold Star annual training plan.

Confirm which leadership appointments Gold Star cadets will be completing.

Obtain a copy of the corps Full Value Contract (FVC) developed during EO M107.01 (Participate in a Discussion on Year One Training). Where a FVC is not developed or will be developed again, photocopy the examples located at Attachment A.

PRE-LESSON ASSIGNMENT

Nil.

APPROACH

An interactive lecture was chosen for TPs 1, 2 and 4 to orient the cadets to and generate interest in Gold Star training opportunities.

A group discussion was chosen for TP 3 as it allows the cadets to interact with their peers and share their knowledge, experiences, opinions, and feelings about opportunities for leadership appointments at the corps. Sharing in the discussion encourages the cadet to examine their own thoughts and feelings and may prompt them to re-examine their previously held ideas. Participating in a group discussion improves the cadet's listening skills and team development.

INTRODUCTION

REVIEW

Nil.

OBJECTIVES

By the end of this lesson the cadet shall have identified the training opportunities they will receive in Gold Star.

IMPORTANCE

It is important for cadets to receive an overview of the training that will be conducted during Gold Star as it may create eagerness and excitement to complete a year of new training experiences and leadership opportunities. The updates in the corps FVC should energize the cadets individually and as a group for the upcoming training year.

Teaching Point 1**Identify Gold Star mandatory training opportunities.**

Time: 5 min

Method: Interactive Lecture

Gold Star mandatory training is a plan of activities that corps, and specialized training establishments (expedition centres), must conduct for Gold Star cadets. Mandatory training is conducted as follows:

1. sixty periods of instruction to be conducted during training sessions (3 periods per session);
2. eighteen periods of instruction to be conducted during two mandatory training days (9 periods per day);
3. eighteen periods of instruction to be conducted during one weekend bivouac Field Training Exercise (FTX); and
4. eighteen periods of instruction to be conducted during one weekend expedition exercise at an expedition centre.

TRAINING COMMON TO SEA, ARMY AND AIR CADETS

As in Green, Red and Silver Star, there is training in Gold Star which is common and applies to sea, army and air cadets. POs for common training this year include:

| PO No. | Topic | PO Statement |
|--------|-------------------------------------|---|
| 401 | Citizenship | Recognize How the Legal System Affects Youth |
| 402 | Community Service | Perform Community Service |
| 403 | Leadership | Act as a Team Leader |
| 404 | Personal Fitness and Healthy Living | Update Personal Activity Plan |
| 405 | Recreational Sports | Participate in Recreational Sports |
| 406 | Air Rifle Marksmanship | Fire the Cadet Air Rifle During Recreational Marksmanship |
| 407 | General Cadet Knowledge | Serve in an Army Cadet Corps |
| 408 | Drill | Command a Platoon on Parade |
| 409 | Instructional Techniques | Instruct a Lesson |
| 411 | Biathlon | (Complementary Only) |



The Annual Ceremonial Review (ACR) is also common to all three elements of cadets, but there is no specific training allocated for it.

Sea, army and air cadets are required to complete six periods of Positive Social Relations for Youth training during year four.

ARMY CADET ELEMENTAL TRAINING

There is training in Gold Star that is specifically designed for army cadets. POs for the army cadet specific training this year include:

| PO No. | Topic | PO Statement |
|--------|--------------------------------------|---|
| 420 | Canadian Forces (CF) Familiarization | Identify the Structure of the Canadian Army |
| 421 | Field Training | (Complementary Only) |
| 422 | Navigation | Follow a Multi-Leg Route Using a Global Positioning System (GPS) Receiver |
| 423 | Trekking | (Complementary Only) |

| | | |
|-----|---------------------|--|
| 424 | Wilderness Survival | Employ Natural Resources in a Survival Situation |
| 425 | Outdoor Leadership | Develop an Expedition Plan |
| 426 | Expedition | Perform Expedition Skills |

Expedition is one activity that distinguishes army cadets from the other cadet elements. Expedition is defined as any activity that consists of dynamic travel of no less than 36 hours in duration, where there is a clear goal associated with the activity. In Gold Star training, expedition is supported by PO 422 (Navigation), PO 424 (Wilderness Survival), PO 425 (Outdoor Leadership) and PO 426 (Expedition). In Gold Star, cadets will have the opportunity to attend a weekend Expedition Exercise at a Regional Expedition Centre.

Assessment is an important aspect of cadet training. It is designed to assist cadets and their instructors to meet the training targets set for each PO. Cadets will be informed of the requirements prior to assessment starting. After the assessment is completed, the cadet will be informed of their results and given a copy to keep. The POs and methods to be assessed include:

- 403 (Act as a Team Leader). Performance assessment and personal communication.
- 408 (Command a Platoon on Parade). Performance assessment.
- 409 (Instruct a Lesson). Performance assessment.
- 422 (Follow a Multi-Leg Route Using a GPS Receiver). Performance assessment.
- 424 (Employ Natural Resources in a Survival Situation). Performance Assessment.
- 426 (Perform Expedition Skills). Performance assessment and personal communication.



The details for each assessment can be located at A-CR-CCP-704/PG-001, *Gold Star Qualification Standard and Plan*, Chapter 3, Annex B.

CONFIRMATION OF TEACHING POINT 1

QUESTIONS:

- Q1. What PO interests you the most? Why?
- Q2. How many periods of Positive Social Relations for Youth training are Gold Star cadets required to complete?
- Q3. Which POs support expedition training in Silver Star?

ANTICIPATED ANSWERS:

- A1. Answers will vary.
- A2. Six periods.
- A3. Expedition training in Gold Star is supported by POs 422 (Navigation), 424 (Wilderness Survival), 425 (Outdoor Leadership) and 426 (Expedition).

Teaching Point 2**Identify Gold Star complementary training opportunities.**

Time: 5 min

Method: Interactive Lecture



This TP will vary by cadet corps. Refer to the corps annual training plan and discuss the complementary training the cadet corps will conduct throughout the Gold Star program.

Gold Star complementary training is a plan of activities that corps and specialized training establishments may conduct. These activities complement mandatory activities and form an integral part of the Star Level program. Every PO identified in TP 1, except for PO 426 (Perform Expedition Skills) has complementary activities available to be selected. Commanding Officers (COs) have the discretion to choose activities from a range of possibilities, thus allowing them flexibility to tailor Gold Star training to match the corps' interests and resources.

CONFIRMATION OF TEACHING POINT 2**QUESTIONS:**

- Q1. What complementary training is being conducted in Gold Star that is also available to sea and air cadets?
- Q2. What army cadet specific complementary training is being conducted in Gold Star?
- Q3. What complementary training is most interesting as a Gold Star cadet?

ANTICIPATED ANSWERS:

- A1. Answers will only be from common POs.
- A2. Answers will vary.
- A3. Answers will vary.

Teaching Point 3**Discuss leadership appointment opportunities at the corps.**

Time: 5 min

Method: Group Discussion

BACKGROUND KNOWLEDGE

The point of the group discussion is to draw the following information from the group using the tips for answering / facilitating discussion and the suggested questions provided.

LEADERSHIP ASSIGNMENT

A leadership assignment is a specific, short- or long-term practical leadership opportunity where the team leader applies leadership skills. The team leader will have temporary team members either within or outside their peer group. The team will accomplish a single minor duty or task.



Leadership assignments in Gold Star may be the same as Silver Star or of a longer duration, with or without greater complexity. Each cadet should have already completed at least two leadership assignments during Silver Star.

LEADERSHIP APPOINTMENT

A leadership appointment is a long-term practical leadership opportunity. The team leader must apply their leadership knowledge and skills and display the core leadership qualities of a cadet. The team leader will have an assigned, established team of cadets outside their peer group. These may be organizational appointments (eg, Platoon Warrant Officer), training appointments (eg, Star Level Instructor) or supplementary appointments (eg, Drill Team Commander). These appointments must be based on the frequency and duration of the major duties or tasks. The team leader must meet with their team on a number of occasions to provide feedback and mentoring. Leadership appointments may be held by a single fourth year cadet (eg, Drill Team Commander) or the fourth year cadets may rotate through a position (eg, Canteen Steward).

The team leader must supervise, communicate, solve problems, motivate and provide feedback to all team members while striving to meet their needs and expectations. The team leader must attempt to develop the skills and knowledge of their team members.

Direction for the leadership appointment must be given by a superior, usually an activity leader or activity manager.



During Gold Star, each cadet will be assessed at least once on a leadership assignment and once on a leadership appointment.

SAMPLE YEAR FOUR LEADERSHIP APPOINTMENTS



This list is not inclusive. For further information and a complete list of leadership appointments, see A-CR-CCP-704/PF-001, *Gold Star Instructional Guides*, EO M403.06 (Act as a Team Leader During a Leadership Appointment).

Organizational Appointments:

- Regimental Sergeant Major (RSM),
- Company Sergeant Major (CSM),
- Platoon Warrant Officer,
- Drum Major,
- Flag Party Commander,
- Training Assistant,
- Supply Assistant, and
- Administration Assistant.

Training Appointments:

- Star Level Non-commissioned Officer (NCO),
- Drill and Ceremonial Instructor,
- Expedition Instructor,
- Fitness and Sports Instructor,
- Music Instructor, and
- Air Rifle Marksmanship Instructor.

Supplementary Appointments:

- Band Section Leader,
- Canteen Steward,
- Drill Team Commander,
- Marksmanship Team Captain,
- First Aid Team Captain,
- Biathlon Team Captain, and
- Sports Team Captain (only if there is a sufficient frequency and duration for practices, games and tournaments).



Gold Star cadets will typically be assigned leadership appointments of Platoon Warrant Officer or supplementary appointments. As required, Gold Star cadets may be assigned various other organizational and training appointments.



For the purposes of PO 403 (Act as a Team Leader), Gold Star cadets will be required to fill a leadership appointment that meets the criteria defined above. The appointment involves an assigned, established team of cadets outside the Gold Star cadets peer group. In some circumstances, some of the examples may not meet the criteria (eg, a smaller corps that only has one cadet assigned to supply).

GROUP DISCUSSION



TIPS FOR ANSWERING / FACILITATING DISCUSSION:

- Establish ground rules for discussion, eg, everyone should listen respectfully; don't interrupt; only one person speaks at a time; no one's ideas should be made fun of; you can disagree with ideas but not with the person; try to understand others as much as you hope they understand you; etc.
- Sit the group in a circle, making sure all cadets can be seen by everyone else.
- Ask questions that will provoke thought; in other words avoid questions with yes or no answers.
- Manage time by ensuring the cadets stay on topic.
- Listen and respond in a way that indicates you have heard and understood the cadet. This can be done by paraphrasing their ideas.
- Give the cadets time to respond to your questions.
- Ensure every cadet has an opportunity to participate. One option is to go around the group and have each cadet answer the question with a short answer. Cadets must also have the option to pass if they wish.
- Additional questions should be prepared ahead of time.

SUGGESTED QUESTIONS:

- Q1. What is the difference between a leadership assignment and a leadership appointment?
- Q2. What leadership appointments are available at the corps?
- Q3. Do you have any concerns knowing that you will fill a leadership appointment during this training year?



Other questions and answers will develop throughout the group discussion. The group discussion should not be limited to only those suggested.



Reinforce those answers given and comments made during the group discussion, ensuring the teaching point has been covered.

CONFIRMATION OF TEACHING POINT 3

The cadets' participation in the group discussion will serve as the confirmation of this lesson.

Teaching Point 4**Review the goals of a FVC.**

Time: 10 min

Method: Interactive Lecture



A corps FVC was developed in EO M107.01 (Participate in a Discussion on Year One Training) and revisited in Red and Silver Star as a refresher of the FVC.

Review the elements of the corps' existing FVC. All cadets should be aware of the corps goals that were developed.

The cadets may agree that some goals need to be changed, added or even deleted.

GOALS OF THE FVC

A FVC can take many forms. Examples are located at Attachment A.

Before establishing a FVC, everyone must be ready to commit to common goals.

Be here. The FVC asks everyone to make a conscious commitment to be present in body and mind, as well as to commit to full participation and to accept and demonstrate responsibility for their actions. This means that everyone shows interest in supporting others and actively engaging in the learning process.

Be safe. In order to stimulate interest, facilitate participation and create an open-minded environment for the group members, everyone must feel safe. It is the instructor's responsibility to ensure that team members feel physically and emotionally safe in order to contribute to their learning process. This responsibility also falls on group members. Behaviours and attitudes must not put other group members at risk. A safe environment will encourage each member to actively participate, ask questions and give answers without fear of being ridiculed.

Set goals. It is essential that everyone set personal goals. These goals provide the person and the group reference points to make choices about actions and plans. In every learning process, it is imperative to set goals. Once goals are set, group members and individuals will take on the responsibility to reach them. The FVC calls for the members of a group to work collectively toward the attainment of group goals and to support each other to meet individual goals.

Be honest. Being honest assumes that one is honest with others and with oneself. For example, in a situation of disappointment or anger, the team members must simply acknowledge their feelings in regard to the situation and openly and fairly explain their state of mind. In this situation, everybody will be able to work toward solving the problem. Being honest requires members to be accountable to each other and responsible for their own actions and words.

Let go and move on. The FVC requires that group members acknowledge that they will not always agree and that they will have different opinions and ideas. In this instance, members must choose to put aside differences and move forward in order to achieve the goals.

CONFIRMATION OF TEACHING POINT 4

QUESTIONS:

- Q1. What are the goals of the FVC?
- Q2. In the FVC, what does 'be honest' imply?
- Q3. What must happen before letting go and moving on?

ANTICIPATED ANSWERS:

- A1. The goals of the FVC are:
- be here;
 - be safe;
 - set goals;
 - be honest; and
 - let go and move on.
- A2. That everyone is honest with others and themselves.
- A3. Everyone must choose to put aside differences and move forward in order to achieve the goals.

END OF LESSON CONFIRMATION

QUESTIONS:

- Q1. What POs are army specific?
- Q2. What leadership appointments interest you?
- Q3. What changes have you noticed in the FVC over the years?

ANTICIPATED ANSWERS:

- A1. The following POs are army specific:
- 420 (CF Familiarization),
 - 421 (Field Training [complementary only]),
 - 422 (Navigation),
 - 423 (Trekking),
 - 424 (Wilderness Survival),
 - 425 (Outdoor Leadership), and
 - 426 (Expedition).
- A2. Answers will vary.
- A3. Answers will vary.

CONCLUSION

HOMEWORK / READING / PRACTICE

Nil.

METHOD OF EVALUATION

Nil.

CLOSING STATEMENT

Knowing what to expect in the Gold Star program allows an understanding of the training ahead. It also aids in maintaining interest and anticipation of the emerging leadership opportunities for a Gold Star cadet.

INSTRUCTOR NOTES / REMARKS

For Gold Star complementary training opportunities in TP 2, refer to the corps' annual training plan.

This EO should be scheduled as early as possible in the training year. See the sample schedule located at A-CR-CCP-704/PG-001, *Gold Star Qualification Standard and Plan*, Chapter 2, Annex C.

REFERENCES

A0-096 CATO 11-04 Director Cadets 3. (2007). *Cadet program outline*. Ottawa, ON: Department of National Defence.

A2-077 CATO 40-01 Director Cadets 4. (2008). *Army cadet program outline*. Ottawa, ON: Department of National Defence.

C2-038 ISBN 0-7872-2459-6 Henton, M. (2006). *Adventure in the classroom: Using adventure to strengthen learning and build a community of life-long learners*. Dubuque, IA: Kendall Hunt Publishing.

THIS PAGE INTENTIONALLY LEFT BLANK

Full Value Contract: The Circle

1. Draw a wheel. At the centre of the wheel, draw a circle. This circle represents the individuals, the group, and the goals.
2. Draw rays from this circle. On these rays, write each selected value.
3. The outer circle symbolizes that the group is one and that all members go toward the same direction.
4. Without the respect of the chosen values by everyone, the group could not make a wheel, and could not walk toward the same goals.

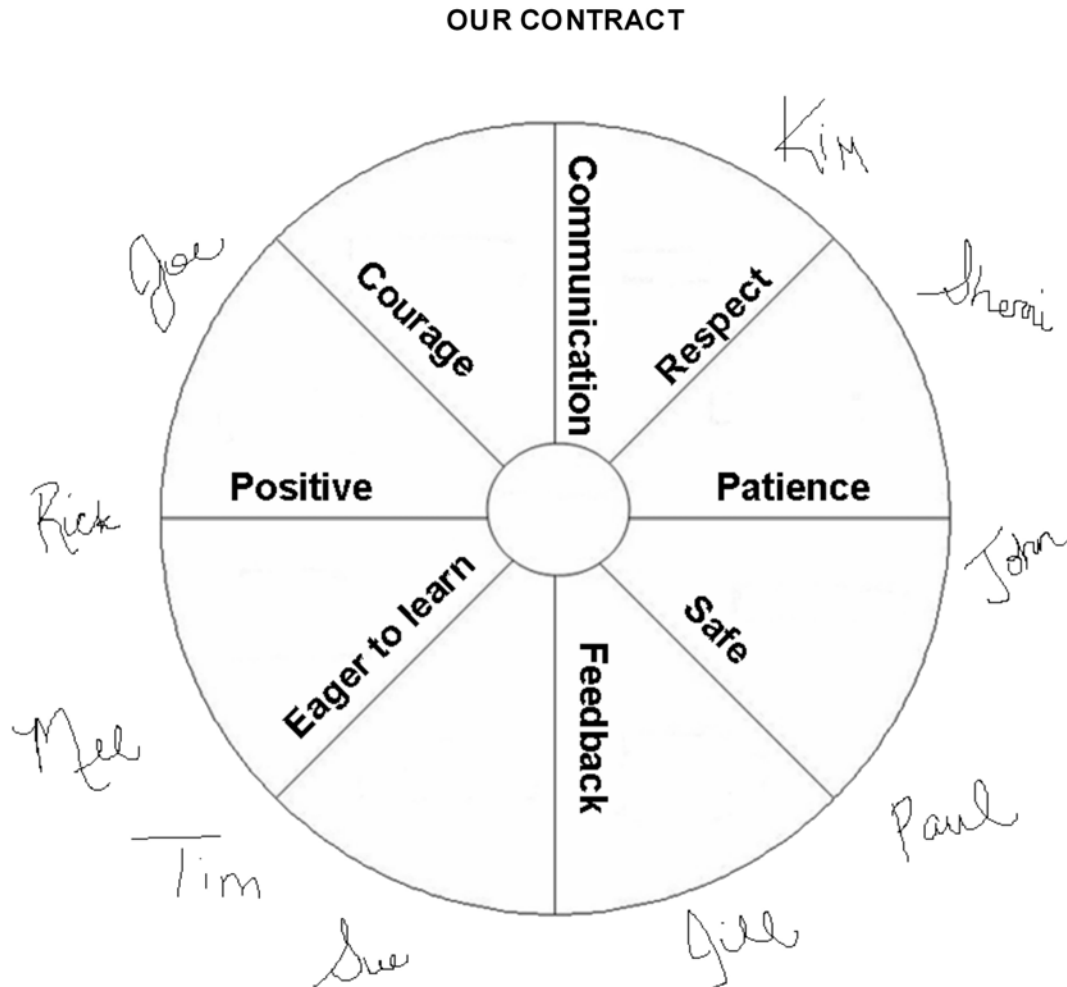

Figure A-1 The Circle

Note. Created by Director Cadets 3, 2007, Ottawa ON: Department of National Defence.

Full Value Contract: The Village

1. Draw a frame (village) on cardboard or flipchart paper.
2. Have the cadets think about values, qualities, and behaviours that make them feel safe and respected, both as an individual and in a group setting.
3. Have each cadet select their most important value, quality, or behaviour.
4. Have each cadet represent what they chose by drawing or writing it on a piece of paper.
5. Have each cadet glue their drawing or writing inside the village and briefly explain to the others why that choice was made.
6. Repeat the activity by including something that will prevent the group from reaching their goals and affect the running of the village.
7. Have each cadet explain why they chose their representation.
8. Have each cadet glue their drawing or writing outside the village.
9. Discuss the values selected by the cadets (inside and outside the village) and ask if everyone agrees. The cadets must understand that they are agreeing to respect each person's value, quality or behaviour in order for the cadet corps (village) to run properly and be a place where everyone will feel safe and respected.
10. After everyone has agreed, everyone (staff and cadets) will sign the village.

Full Value Contract: The Five-Finger Contract

Each finger will represent a value that will help the group members feel secure, respected, and part of the group.

The five fingers on the hand represent the following:

- the little finger = safety,
 - the ring finger = commitment,
 - the middle finger = respect of others,
 - the index finger = taking responsibilities, and
 - the thumb = agreement to work toward the group's goals.
1. On a piece of cardboard or flip chart paper, write the representations of the fingers. Discuss the elements with the group so that all cadets have a clear understanding. Each cadet must agree that these five elements are important for group members to feel secure, respected, and part of the group.
 2. Have each cadet draw his / her hand on a sheet of paper and write inside each finger the element associated with each.
 3. Have each cadet sign their hand and glue it on bristol board or flip chart paper. The set of the group's hands represents everyone's commitment to each other.



Figure A-2 The Five Finger Contract

Note. Created by Director Cadets 3, 2007, Ottawa ON: Department of National Defence.

Full Value Contract: The Being

1. Draw the outline of a body on two pieces of flip chart paper, taped together.
2. Inside the outline, have the cadets draw or write the behaviours, qualities or values that will make the environment safe and a place where everyone is respected.
3. Outside the outline, have the cadets draw or write the behaviours, qualities or values that will prevent the environment from being safe and a place where everyone is respected.
4. Cadets must agree on the meaning of each word and explain their choices.
5. Have all cadets sign the being.



Figure A-3 The Being

Note. From *Adventure in the Classroom: Using Adventure to Strengthen Learning and Build a Community of Life-Long Learners* (p. 74), by M. Henton, 1996, Dubuque, IA: Kendall Hunt Publishing. Copyright 1996 by Project Adventure, Inc.

Full Value Contract: The Chain of Hands

1. Have the cadets write a list of words and sentences that describe how they would like to be treated and how they will treat the other group members in order to feel safe and respected.
2. From this list, have the cadets select the 10 most important for the group.
3. On a sheet of flip chart paper (two may be required), have the cadets draw their hands around the sheet. Write the 10 selected words or sentences in the middle of the sheet.
4. Have the cadets sign his or her own hand.



Figure A-4 The Chain of Hands

Note. Created by Director Cadets 3, 2007, Ottawa ON: Department of National Defence.

Full Value Contract: What do I need? What can I give?

1. Give two pieces of different coloured paper to each cadet.
2. Ask the cadets to think about what they need in order to feel secure and respected in the group.
3. Have the cadets write the most important item they need on one of the pieces of paper.
4. Have the cadets think about what they could provide to the group in order to have other team members feel safe and respected in the group.
5. On the remaining piece of paper, have the cadets write the most important item.
6. When done writing on both pieces of paper, have the cadets present what they wrote to the group.
7. Once everyone has explained what they need and what they can provide, glue those pieces of papers on cardboard or flip chart paper, making sure that both categories are spilt up.
8. Ask the cadets if they need more explanations and then have everyone sign.



ROYAL CANADIAN ARMY CADETS

GOLD STAR

INSTRUCTIONAL GUIDE



SECTION 2

EO M407.02 – IDENTIFY YEAR FOUR CADET SUMMER TRAINING CENTRE (CSTC) TRAINING OPPORTUNITIES

Total Time: 30 min

PREPARATION

PRE-LESSON INSTRUCTIONS

Resources needed for the delivery of this lesson are listed in the lesson specification located in A-CR-CCP-704/PG-001, *Gold Star Qualification Standard and Plan*, Chapter 4. Specific uses for said resources are identified throughout the instructional guide within the TP for which they are required.

Review the lesson content and become familiar with the material prior to delivering the lesson.

Review year four CSTC training opportunities found at CATO 40-01, *Army Cadet Program Outline*, as the prerequisites for courses may change.

Review CSTC staff cadet employment opportunities found at CATO 13-28, *Advanced Training—Staff Cadets*, as the prerequisites for positions may change.

PRE-LESSON ASSIGNMENT

Nil.

APPROACH

A group discussion was chosen for TP 1 as it allows the cadets to interact with their peers and share their experiences, opinions, and feelings about year four CSTC training opportunities. Sharing in the discussion encourages the cadets to examine their own thoughts and feelings and may prompt them to re-examine their previously held ideas. Participating in a group discussion improves the cadets' listening skills and team development.

An interactive lecture was chosen for TPs 2 and 3 to orient the cadets to the selection process for year four CSTC training opportunities and to generate interest.

INTRODUCTION

REVIEW

Nil.

OBJECTIVES

By the end of this lesson the cadet shall have identified year four CSTC training opportunities.

IMPORTANCE

It is important for cadets to identify year four CSTC training and employment opportunities because as Gold Star cadets, each cadet should know the available options for summer training or employment. Some year four opportunities are the same as year three opportunities, with some additions. These opportunities will enable cadets to professionally develop in the program by transitioning from a course cadet to a staff cadet. The ability to set early goals will prepare them for future opportunities.

Teaching Point 1**Review the specialty areas for year four CSTC training.**

Time: 5 min

Method: Group Discussion

BACKGROUND KNOWLEDGE

The point of the group discussion is to draw the following information from the group using the tips for answering / facilitating discussion and the suggested questions provided.

Write the specialty areas on a whiteboard / flip chart and discuss the activities associated with each area.

Cadets will have already completed courses in these specialty areas and will have a general idea of the activities associated with each area.

CEREMONIAL LEADERSHIP

Cadets will develop the knowledge and skills required to improve leadership abilities in a peer and small group setting. Topics include:

- leadership,
- confidence building,
- problem solving, and
- ceremonial drill.

EXPEDITION LEADERSHIP

Cadets will develop expedition knowledge and skills in a field setting. Topics include:

- adventure training activities,
- field training,
- trekking,
- navigating,
- wilderness survival, and
- expedition.

FULLBORE MARKSMANSHIP

Cadets will develop the knowledge and skills required to improve fullbore marksmanship abilities. Topics include:

- marksmanship with fullbore rifles,
- recreational marksmanship, and
- course level marksmanship competition.

AIR RIFLE MARKSMANSHIP

Cadets will develop the knowledge and skills required to improve air rifle marksmanship abilities. Topics include:

- two-position shooting (standing and prone),
- recreational marksmanship,
- course level marksmanship competition, and
- biathlon.

FITNESS AND SPORTS

Cadets will improve individual fitness and sports knowledge and skills. Topics include:

- studying personal fitness;
- studying rules and regulations of sports; and
- organizing and delivering sports activities.

MILITARY BAND

Cadets will develop music knowledge and skills. Topics include:

- studying music theory;
- playing an instrument as part of an ensemble;
- playing an instrument as part of a military band; and
- developing individual music skills.

PIPE BAND

Cadets will develop music knowledge and skills. Topics include:

- studying music theory;
- playing an instrument as part of an ensemble;
- playing an instrument as part of a pipe and drum band; and
- developing individual music skills.

GROUP DISCUSSION



TIPS FOR ANSWERING / FACILITATING DISCUSSION:

- Establish ground rules for discussion, eg, everyone should listen respectfully; don't interrupt; only one person speaks at a time; no one's ideas should be made fun of; you can disagree with ideas but not with the person; try to understand others as much as you hope they understand you; etc.
- Sit the group in a circle, making sure all cadets can be seen by everyone else.
- Ask questions that will provoke thought; in other words avoid questions with yes or no answers.
- Manage time by ensuring the cadets stay on topic.
- Listen and respond in a way that indicates you have heard and understood the cadet. This can be done by paraphrasing their ideas.
- Give the cadets time to respond to your questions.
- Ensure every cadet has an opportunity to participate. One option is to go around the group and have each cadet answer the question with a short answer. Cadets must also have the option to pass if they wish.
- Additional questions should be prepared ahead of time.

SUGGESTED QUESTIONS:

- Q1. Which summer training activities interest you?
- Q2. Who is interested in applying for summer training this year? Why?
- Q3. What areas of interest do you plan to pursue? Why?



Other questions and answers will develop throughout the group discussion. The group discussion should not be limited to only those suggested.



Reinforce those answers given and comments made during the group discussion, ensuring the teaching point has been covered.

CONFIRMATION OF TEACHING POINT 1

The cadets' participation in the group discussion will serve as the confirmation of this TP.

Teaching Point 2**Describe year four CSTC courses.**

Time: 15 min

Method: Interactive Lecture



A cadet who has attended one of these courses could be asked to speak about their experience during this TP.

COMMON COURSES

The CSTC courses listed below are common and apply to sea, army and air cadets.



Refer to CATO 40-01, *Army Cadet Program Outline* for prerequisites.

Air Rifle Marksmanship Instructor. The aim of this course is to develop specialist knowledge and skills in air rifle marksmanship and biathlon. This will allow the cadet to assist in the development and implementation of a competitive marksmanship program and instruct marksmanship training in the corps program. This six-week course is regionally conducted.

Fitness and Sports Instructor. The aim of this course is to improve individual fitness and develop the knowledge and skills needed to allow the cadet to assist in the organization and delivery of various sports activities. This six-week course is regionally conducted.

Military Band–Intermediate Musician and Advanced Musician. The aims of these courses are to expand on the knowledge and skills required to play and lead a unit military band. Both six-week courses are regionally conducted.

Pipe Band–Intermediate Musician and Advanced Musician. The aims of these courses are to expand on the knowledge and skills required to play and lead a unit pipe band. Both six-week courses are regionally conducted.

ARMY CADET ELEMENTAL COURSES

The CSTC courses listed below are specifically designed for army cadets.

Drill and Ceremonial Instructor. The aim of this course is to continue to develop leadership knowledge and skills required for junior leadership positions supporting the corps program. It also develops a specialty in drill and ceremonial and drill instruction. This six-week course is regionally conducted.

Expedition Instructor. The aim of this course is to develop subject matter knowledge and specialist skills required to successfully participate in and lead during an intermediate level expedition. This six-week course is regionally conducted.

Leadership and Challenge. The aim of this course is to develop a specialist with the hard skills, attitude and subject matter knowledge required to successfully participate in and lead expeditions. This six-week course is nationally conducted.

Fullbore Marksman Phase II. The aim of this course is to develop a specialist with the attitude, skills and subject matter knowledge required to participate in competitive fullbore marksmanship as a member of a competitive team. This six-week course is nationally conducted and selection is primarily drawn from cadets who are merit listed during the Fullbore Marksman Phase I qualification.

CONFIRMATION OF TEACHING POINT 2

QUESTIONS:

- Q1. What year four CSTC courses are common to sea, army and air cadets?
- Q2. What year four CSTC courses are only for army cadets?
- Q3. What CSTC courses are only available to year four cadets?

ANTICIPATED ANSWERS:

- A1. Year four CSTC common courses include:
- Air Rifle Marksmanship Instructor,
 - Fitness and Sports Instructor,
 - Military Band–Intermediate Musician and Advanced Musician, and
 - Pipe Band–Intermediate Musician and Advanced Musician.
- A2. Year four CSTC courses for army cadets only include:
- Drill and Ceremonial Instructor,
 - Expedition Instructor,
 - Leadership and Challenge, and
 - Fullbore Marksman Phase II.
- A3. The courses only available to year four cadets are:
- Leadership and Challenge, and
 - Fullbore Marksman Phase II.

Teaching Point 3

Describe staff cadet employment opportunities.

Time: 5 min

Method: Interactive Lecture

STAFF CADETS



The information below provides a brief introduction to what a staff cadet is and the types of opportunities that exist. To obtain more detailed and up to date information CATO 13-28, *Advanced Training–Staff Cadets* should be consulted prior to conducting this lesson.

CATO 13-28, *Advanced Training–Staff Cadets* defines staff cadets as follows:

- Staff cadets are appointed to such rank as is authorized by the Commanding Officer (CO) of a CSTC established to conduct summer training.
- On the authority of the CO of the CSTC, staff cadets may be requested to participate in advanced training, including instructional, supervisory or administrative functions that are approved by the Regional Cadet Support Unit (RCSU) CO for that training centre.
- Staff cadets may not be less than 16 years of age as of the first day of January of the year of advanced training.
- Staff cadets are not employees. Participation by the staff cadet during authorized CSTC summer training constitutes advanced training.



While staff cadets are not considered employees, they do receive pay during their time at a CSTC. Each position has a designated rank that corresponds to pay incentive. For more details see Annexes C and E of CATO 13-28, *Advanced Training–Staff Cadets*.



There are more advanced positions available. For the purpose of this lesson, only positions available to year four cadets will be introduced.

Staff cadet classifications are divided into two distinct categories:

- Type 1—Those who provide direct training to cadets (eg, platoon staff, canoe instructor, and sports instructor), and
- Type 2—Those who have administrative / support roles (eg, canteen staff, storesman, and photographer).



Prerequisites are outlined in CATO 13-28, *Advanced Training–Staff Cadets* for each individual position outlined above.

CONFIRMATION OF TEACHING POINT 3

QUESTIONS:

- Q1. Who authorizes a staff cadet to be appointed to their rank at the CSTC?
- Q2. What is the age requirement for staff employment opportunities?
- Q3. What are the two staff cadet classifications?

ANTICIPATED ANSWERS:

- A1. Staff cadets are appointed to such rank as is authorized by the CO of a CSTC established to conduct summer training.
- A2. Staff cadets may not be less than 16 years of age as of the first day of January of the year of advanced training.

A3. Staff cadet classifications are divided into two distinct categories:

- Type 1—Those who provide direct training to cadets (eg, platoon staff, canoe instructors, and sports instructors), and
- Type 2—Those who have administrative / support roles (eg, canteen staff, storesman, and photographers).

END OF LESSON CONFIRMATION

The cadets' participation in the group discussion on year four CSTC opportunities will serve as the confirmation of this lesson.

CONCLUSION

HOMEWORK / READING / PRACTICE

Nil.

METHOD OF EVALUATION

Nil.

CLOSING STATEMENT

Summer training is a fun and exciting aspect of the Cadet Program, which offers training in specialty areas. CSTCs are places to meet other cadets and to make new friends from across Canada. It is important to be familiar with the training and employment options available at CSTCs. This will prepare cadets to plan their training with the intention of preparing for specific employment positions in the future.

INSTRUCTOR NOTES / REMARKS

This EO shall be conducted before the summer training application deadline.

It is recommended that the summer training application forms be completed during a training session after this EO has been conducted.

REFERENCES

A0-033 CATO 14-21 Director Cadets 3. (2004). *Music training and education with the Canadian Cadet Organizations*. Ottawa, ON: Department of National Defence.

A0-096 CATO 11-04 Director Cadets 3. (2007). *Cadet program outline*. Ottawa, ON: Department of National Defence.

A0-128 CATO 13-28 Director Cadets 2. (2006). *Advanced training—Staff cadets*. Ottawa, ON: Department of National Defence.

A2-077 CATO 40-01 Director Cadets 4. (2008). *Army cadet program outline*. Ottawa, ON: Department of National Defence.

THIS PAGE INTENTIONALLY LEFT BLANK



ROYAL CANADIAN ARMY CADETS
GOLD STAR
INSTRUCTIONAL GUIDE



SECTION 3

EO M407.03 – IDENTIFY THE STRUCTURE OF A CADET CORPS

Total Time:

60 min

PREPARATION

PRE-LESSON INSTRUCTIONS

Resources needed for the delivery of this lesson are listed in the lesson specification located in A-CR-CCP-704/PG-001, *Gold Star Qualification Standard and Plan*, Chapter 4. Specific uses for said resources are identified throughout the instructional guide within the TP for which they are required.

Review the lesson content and become familiar with the material prior to delivering the lesson.

Photocopy the Terms of References and Organizational Charts located at Attachments A–S for each cadet.

Photocopy the Activity Scenario Worksheet located at Attachment T for each cadet.

PRE-LESSON ASSIGNMENT

Nil.

APPROACH

An interactive lecture was chosen for TPs 1–3 to give the cadets direction on the structure of a cadet corps and how all cadets can work together to achieve a common training goal(s).

An in-class activity was chosen for TP 4 as it is an interactive way to provoke thought and stimulate interest among the cadets about the duties of the functional, training and duty organizations of a cadet corps.

INTRODUCTION

REVIEW

The review for this lesson is from EO M407.02 (Identify Year Four Cadet Summer Training Centre [CSTC] Training Opportunities).

QUESTIONS:

- Q1. What year four CSTC courses are only for army cadets?
- Q2. Describe the aim of a year four CSTC common or elemental course.
- Q3. Who authorizes a staff cadet to be appointed to their rank at the CSTC?

ANTICIPATED ANSWERS:

A1. Year four CSTC courses for army cadets only include:

- Drill and Ceremonial Instructor,
- Expedition Instructor,
- Leadership and Challenge, and
- Fullbore Marksman Phase II.

A2. Answers may vary.

A3. Staff cadets are appointed to such rank as is authorized by the CO of the CSTC.

OBJECTIVES

By the end of this lesson the cadet shall be able to identify the structure of a cadet corps, to include:

- functional organization,
- training organization, and
- duty organization.

IMPORTANCE

It is important for cadets to understand the structure of a cadet corps and become familiar with the chain of command. Each role within a cadet corps' structure is important and when working together in a cohesive manner, the conduct of a corps' operations will be efficient and successful.

Teaching Point 1**Identify the functional organization of a cadet corps.**

Time: 15 min

Method: Interactive Lecture



This TP is intended to identify the functional organization of a cadet corps and when this organization is most beneficial within a cadet corps.

Distribute the functional terms of references and organizational chart located at Attachments A–I to each cadet.

Where the local cadet corps structure and terms of reference varies, tailor the content of this TP to match.

A cadet corps is divided into three organizations—functional, training and duty. These organizations work cooperatively to delegate work and responsibility to the officers and cadets of the corps. This helps ensure that no member is overtasked or under-tasked and that no area of the corps is neglected.



Some cadets within the corps structure answer directly to corps officers. The following is a description of the corps officers responsibilities.

- **Commanding Officer (CO).** Responsible for all cadet matters pertaining to the corps and for the training and administration of officers, civilian instructors, and cadets serving within the cadet corps.
- **Training Officer (Trg O).** Responsible to the CO for all training matters pertaining to the cadet corps.
- **Platoon Commander (PI Comd).** Responsible to the CO for all matters pertaining to the platoon.
- **Administration Officer (Adm O).** Responsible to the CO for all administration and personnel matters pertaining to the cadet corps.
- **Supply Officer (Sup O).** Responsible to the CO for all matters pertaining to supply, transportation and food services for cadet activities.
- **Band Officer (Band O).** Responsible to the CO for the organization, management, administration and general efficiency of the band.

The functional organization outlines the administrative responsibilities of the corps and is based on the parade structure. The following is the functional organization of a cadet corps:

Regimental Sergeant Major (RSM). Answers directly to the CO and is normally the CO's closest advisor on all matters related to the cadets of the corps. The CO normally considers the recommendations of the RSM in the matter of rank appointments, medals, awards, assignments and Non-Commissioned Officer (NCO) training and development. As the most senior cadet, the RSM sets the standard in drill, dress and deportment.

Company Sergeant Major (CSM). Responsible to the RSM and / or CO for the performance of all duties, but is normally supervised by the RSM in routine matters. The CSM is closely involved in monitoring, advising and providing assistance to the Platoon Warrant Officers (PI WOs) and other cadet NCOs. The CSM has a direct interest in supervising cadets assigned to corps headquarters and in maintaining the good order and cleanliness of the corps offices and other facilities. In the field, the CSM plays a key roll in the establishment and operation of the field headquarters.

Platoon Warrant Officer (PI WO). Responsible for the same administrative responsibilities for the platoon as the RSM has for the corps. The PI WO is an advisor to the PI Comd in matters concerning the cadets in the platoon. The PI WO is always informed of the overall plan and timings and is fully capable of leading the platoon.

Drum Major (DM). Responsible to the Band O for controlling the musical action and the drill movements of a band during parades. The drum major is the Band O's closest advisor on all matters related to the band.



Pipe Major (PM). When there is no drum major in a pipe band, the pipe major is responsible for the overall welfare of the band. When there is a drum major, the pipe major is responsible for the pipe section.

Flag Party Commander (Flag Party Comd). Responsible for training and supervising the members of the flag party.

Training Assistant. Responsible to the Trg O for matters related to the training of the corps. The training assistant ensures that timings are met, the schedule is followed and instructors are prepared.

Supply Assistant. Responsible to the Sup O for maintaining clothing and equipment, ensuring they are in serviceable condition. The supply assistant also helps with the issuing of clothing and equipment.

Administration Assistant. Responsible to the Adm O for maintaining and preparing files and required forms and ensuring the orderly room is clean and tidy for visitors.

CONFIRMATION OF TEACHING POINT 1

QUESTIONS:

- Q1. Who does the RSM answer to directly?
- Q2. What is the DM responsible for?
- Q3. What is the supply assistant responsible for?

ANTICIPATED ANSWERS:

- A1. The RSM answers directly to the CO.
- A2. The DM is responsible to the Band O for controlling the musical action and the drill movements of a band during parades.
- A3. The supply assistant is responsible to the Sup O for maintaining clothing and equipment, ensuring they are in serviceable condition.

Teaching Point 2**Identify the training organization of a cadet corps.**

Time: 10 min

Method: Interactive Lecture



This TP is intended to identify the training organization of a cadet corps and when this organization is most beneficial within a cadet corps.

Distribute the training terms of references and organizational chart located at Attachments J–P to each cadet for reference.

Where the local cadet corps structure and terms of reference varies, tailor the content of this TP to match.

The training organization assists with the implementation and delivery of the corps training program, as directed by the CO and the Trg O. The following is the training organization of a cadet corps:

Star Level NCO. Each star level may have one or more NCOs to perform the duties of an instructor and team leader by teaching, facilitating and supervising star level training.



Some cadets within the corps structure answer directly to corps officers. The Course Officer is responsible to the Trg O for all training matters pertaining to their particular star level.

Specialist Instructors. Provide the opportunity for senior cadets to instruct, supervise, practice and develop advanced skills in specialized activities. The following are specialty instructors:



While it is desirable for a cadet unit to have a complete range of specialist instructors, it is not expected that every corps would have every specialist instructor represented.

- **Drill and Ceremonial Instructor.** Performs the duties of a specialist instructor during drill-based lessons and acts as a team leader on the parade square and during ceremonies by supervising drill and setting the example in dress, drill and deportment.
- **Expedition Instructor.** Performs the duties of a specialist instructor during expedition-based lessons and acts as a team leader by performing field maintenance on expedition equipment and supervising expedition training.
- **Fitness and Sports Instructor.** Performs the duties of a specialist instructor during fitness and sports-based lessons and acts as a team leader by organizing, coaching and refereeing fitness and sports activities and administering the fitness protocols.
- **Music Instructor.** Performs the duties of a specialist instructor during music-based lessons and acts as a team leader by assisting with the overall management of the band by directing and scheduling music training.



Each musical section (eg, pipers, drummers, woodwind) may have their own music instructor.

- **Air Rifle Marksmanship Instructor.** Performs the duties of a specialist instructor during marksmanship-based lessons and acts as a team leader by planning and organizing recreational marksmanship and biathlon activities as part of the corps mandatory and complementary marksmanship training. The air rifle marksmanship instructor is responsible to the Range Safety Officer (RSO).



Some cadets within the corps structure answer directly to corps officers. The RSO is responsible to the CO for the overall safety of every person and activity, when on a range.

CONFIRMATION OF TEACHING POINT 2

QUESTIONS:

- Q1. How does the Drill and Ceremonial Instructor assist with the implementation and delivery of the corps training program?
- Q2. How does the Expedition Instructor assist with the implementation and delivery of the corps training program?
- Q3. Who is the Air Rifle Marksmanship Instructor responsible to?

ANTICIPATED ANSWERS:

- A1. The Drill and Ceremonial Instructor performs the duties of a specialist instructor and team leader on the parade square and during ceremonies by instructing drill and setting the example in dress, drill and deportment.
- A2. The Expedition Instructor performs the duties of a specialist instructor during expedition-based lessons and acts as a team leader by performing field maintenance on expedition equipment and supervising expedition training.
- A3. The Air Rifle Marksmanship Instructor is responsible to the RSO.

Teaching Point 3

Identify the duty organization of a cadet corps.

Time: 5 min

Method: Interactive Lecture



This TP is intended to identify the duty organization of a cadet corps and when this organization is most beneficial within a cadet corps.

Distribute the duty terms of references and organizational chart located at Attachments Q–S to each cadet for reference.

Duty personnel are a group of selected cadets who, on a rotational basis, look after the safety, conduct and appearance of the corps building. The following is the duty organization of a cadet corps:



Some cadets within the corps structure answer directly to corps officers. The Duty Officer (Duty O) is responsible to the CO for looking after the safety, conduct and appearance of the corps building.

Duty NCO. Should be the first cadet to arrive and the last cadet to leave on a parade night. Throughout the parade night, the duty NCO is responsible to the Duty O to ensure that timings are met and the building is clean.

Duty Assistants. As there are so many duty responsibilities on a parade night, duty assistants are important and required, should the duty NCO be busy or absent, as they assist the Duty NCO in their nightly duties.

CONFIRMATION OF TEACHING POINT 3

QUESTIONS:

- Q1. When should the duty NCO arrive and leave on a parade night?
- Q2. Who is the duty NCO responsible to?
- Q3. Why are duty assistants required on a parade night?

ANTICIPATED ANSWERS:

- A1. The duty NCO should be the first cadet to arrive and the last cadet to leave on a parade night.
- A2. The duty NCO is responsible to the Duty O.
- A3. As there are so many duty responsibilities on a parade night, duty assistants are important and required, should the duty NCO be busy or absent.

Teaching Point 4

Conduct an activity to have the cadets identify NCO responsibilities in a cadet corps.

Time: 20 min

Method: In-Class Activity

ACTIVITY

OBJECTIVE

The objective of this activity is to have the cadets identify NCO responsibilities in a cadet corps.

RESOURCES

- Terms of References and Organizational Charts located at Attachments A–S (one per cadet),
- Activity Scenario worksheet located at Attachment T (one per cadet),
- Activity Scenario Answer Sheet located at Attachment U,
- Paper, and
- Pen / pencil (one per cadet).

ACTIVITY LAYOUT

Nil.

ACTIVITY INSTRUCTIONS

1. Divide the cadets into three groups.
2. Have each group choose a team leader and a recorder.
3. Distribute the Activity Scenario worksheet, a piece of paper and a pen / pencil to each cadet.
4. Allow each group 10 minutes to read the activity scenario and to discuss and answer the questions.

5. Circulate and assist the cadets as necessary, offering suggestions and advice.
6. Discuss and review the answers with the class. Refer to the Activity Scenario Answer Sheet, as required.

SAFETY

Nil.

CONFIRMATION OF TEACHING POINT 4

The cadets' participation in the activity will serve as the confirmation of this TP.

END OF LESSON CONFIRMATION

The cadets' identifying of the structure of a cadet corps will serve as the confirmation of this lesson.

CONCLUSION

HOMEWORK / READING / PRACTICE

Nil.

METHOD OF EVALUATION

Nil.

CLOSING STATEMENT

The ability to identify the corps structure and being familiar with the chain of command are important as the cadets become more involved in the cadet corps. Each role within the cadet corps is important, as each role helps ensure the conduct of operations is completed in a timely and efficient manner.

INSTRUCTOR NOTES / REMARKS

Where the local cadet corps structure varies, tailor the content of this EO to match.

REFERENCES

A1-069 A-CR-CCP-603/PG-001 Director Cadets 3. (2009). *Phase Three qualification standard and plan*. Ottawa, ON: Department of National Defence.

A2-083 A-CR-CCP-716/PG-001 Director Cadets 3. (2009). *Expedition Instructor qualification standard and plan*. Ottawa, ON: Department of National Defence.

A2-084 A-CR-CCP-713/PG-001 Director Cadets 3. (2009). *Drill and Ceremonial Instructor qualification standard and plan*. Ottawa, ON: Department of National Defence.

A2-085 A-CR-CCP-832/PG-001 Director Cadets 3. (2009). *Leadership and Ceremonial Instructor qualification standard and plan*. Ottawa, ON: Department of National Defence.

A2-086 A-CR-CCP-902/PG-001 Director Cadets 3. (2009). *Fitness and Sports Instructor qualification standard and plan*. Ottawa, ON: Department of National Defence.

A2-087 A-CR-CCP-903/PG-001 Director Cadets 3. (2009). *Air Rifle Marksmanship Instructor qualification standard and plan*. Ottawa, ON: Department of National Defence.

A2-088 A-CR-CCP-905/PG-001 Director Cadets 3. (2009). *Military Band—Intermediate Musician qualification standard and plan*. Ottawa, ON: Department of National Defence.

A2-089 A-CR-CCP-909/PG-001 Director Cadets 3. (2009). *Pipe Band—Advanced Musician qualification standard and plan*. Ottawa, ON: Department of National Defence.

THIS PAGE INTENTIONALLY LEFT BLANK

TERMS OF REFERENCE—REGIMENTAL SERGEANT MAJOR (RSM)

Responsible to: Commanding Officer (CO)

The RSM is responsible for:

1. Setting and maintaining the standard of dress, discipline, deportment, drill and duties of all Non-Commissioned Officers (NCOs) of the cadet corps.
2. Supervising the Company Sergeant Major (CSM) and monitoring the activities of all unit NCOs in their duties through the appropriate chain of command.
3. Being acquainted with the capabilities of all NCOs and making recommendations regarding their employment within the cadet corps as well as recommendations for rank and courses.
4. Being present for the counselling of cadets and NCOs when requested by the CO.
5. Being present at all inspections by the CO.
6. Keeping the CO informed of any occurrences or cadet personal problems that may affect the welfare of the cadet corps or its personnel.
7. Ensuring cadets are aware of orders and directives, especially those new to the cadet corps.
8. Ensuring that new personnel are promptly met and processed on arrival at the cadet corps.
9. Taking a personal interest and getting involved in training cadets for ceremonial parades, guard mountings and other special activities.
10. Monitoring the training and instruction of cadets.
11. Receiving and consolidating all parade states, status reports and other returns from the NCOs.
12. Ensuring the duty roster for all NCOs is published.
13. Reviewing the A-PD-201-000/PT-000, *The Canadian Forces Manual of Drill and Ceremonial*, and providing advice to the CO and other corps staff on matters related to drill.
14. Instructing NCOs in the subject of drill.
15. Supervising and ensuring NCOs are taught correctly in the subject of drill instruction.
16. Ensuring the overall welfare of cadets and maintaining esprit de corps at a high level.
17. Acting as Parade Commander for the Annual Ceremonial Review and other parades where officers are not on parade.
18. Performing other duties as directed by the CO.

THIS PAGE INTENTIONALLY LEFT BLANK

TERMS OF REFERENCE—COMPANY SERGEANT MAJOR (CSM)

Responsible to: Commanding Officer (CO) / Training Officer (Trg O) / Regimental Sergeant Major (RSM)

The CSM is responsible for:

1. Setting and maintaining the standard of dress, discipline and deportment of all Non-Commissioned Officers (NCOs).
2. Assisting the Trg O by supervising the daily routine throughout the corps with particular emphasis on ensuring the cadet offices are maintained in good order.
3. Forming up company parades, turning them over to the RSM and being present at all inspections.
4. Ensuring roll call is carried out at appropriate times and completion of the parade state for the RSM and the Adm O.
5. Ensuring orders are posted and duty rosters are correct and fair.
6. Keeping the RSM informed of any occurrence affecting the discipline and welfare of the NCOs.
7. Supervising the supply and administration assistant cadets assigned to the corps headquarters.
8. Training and supervising the Flag Party Commander and drill team.
9. Advising the RSM on the progress and performance of NCOs, making recommendations on suitability for advancement or awards.
10. Ensuring the overall welfare and morale of the cadets is maintained at a high level.
11. Acting as Deputy Parade Commander for the Annual Ceremonial Review and other parades where officers are not on parade.
12. Assuming the duties of the RSM if required to do so.
13. Performing other duties as directed by the CO, Trg O or RSM.

THIS PAGE INTENTIONALLY LEFT BLANK

TERMS OF REFERENCE–PLATOON WARRANT OFFICER (PI WO)

Responsible to: Platoon Commander (PI Comd) / Company Sergeant Major (CSM)

The PI WO is responsible for:

1. Setting an example for subordinates in dress, deportment, discipline and conduct.
2. Supervising the platoon Non-Commissioned Officers (NCOs).
3. Ensuring the platoon roll is called at appropriate times.
4. Preparing the platoon parade state for the CSM.
5. Posting or passing along routine orders and any other directions to the platoon.
6. Carrying out administration within the platoon.
7. Inspecting their platoon regularly, correcting deficiencies as required.
8. Being present at all inspections by the PI Comd.
9. Knowing the general plan for any corps activity and the specific plan for platoon activities.
10. Training and supervising the Section Commanders (Sec Comds).
11. Providing advice to the Sec Comds on the conduct of their duties.
12. Maintaining a record of appropriate personal information on each Sec Comd.
13. Instructing lessons as assigned.
14. Ensuring the platoon is well trained in drill.
15. Encouraging the cadets of the platoon to attend training regularly and motivating them to strive for excellence.
16. Ensuring the overall welfare and morale of the cadets in the platoon is maintained at a high level.
17. Acting as PI Comd for the Annual Ceremonial Review and other parades where officers are not on parade.
18. Being prepared to fill in for the PI Comd in their absence.
19. Performing other duties as directed by the PI Comd.

THIS PAGE INTENTIONALLY LEFT BLANK

TERMS OF REFERENCE—DRUM MAJOR (DM)

Responsible to: Band Officer (Band O) / Regimental Sergeant Major (RSM)

The DM is responsible for:

1. Directing the band on parade.
2. Instructing band drill.
3. Planning band drill routines.
4. Ensuring the overall welfare of the band.
5. Maintaining a band drill program.
6. Caring for and maintaining band equipment.
7. Taking attendance and announcing daily orders to the band.
8. Maintaining attendance records.
9. Ensuring the band roll is called at appropriate times.
10. Preparing the band parade state for the CSM.
11. Performing other duties as directed by the Band O.

Note 1. When there is no DM in a pipe band, the pipe major is responsible for the overall welfare of the band.

Note 2. This terms of reference is for a drum major in a pipe band or a military band.

THIS PAGE INTENTIONALLY LEFT BLANK

TERMS OF REFERENCE–FLAG PARTY COMMANDER (Flag Party Comd)

Responsible to: Company Sergeant Major (CSM)

The Flag Party Comd is responsible for:

1. Setting the example for their subordinates in dress, deportment, discipline and conduct.
2. Ensuring members of the Flag Party are familiar with all parade procedures.
3. Training and supervising the members of the Flag Party.
4. Inspecting the Flag Party, correcting deficiencies as required.
5. Performing other duties as directed by the CSM.

THIS PAGE INTENTIONALLY LEFT BLANK

TERMS OF REFERENCE–TRAINING ASSISTANT

Responsible to: Training Officer (Trg O) / Company Sergeant Major (CSM)

The Training Assistant is responsible for:

1. Ensuring all lessons start and end on time.
2. Ensuring all instructors are prepared for their lesson(s).
3. Providing reference material or training aids to instructors.
4. Being prepared to teach a lesson(s), if an instructor is absent.
5. Ensuring the training records for cadets are being maintained.
6. Assessing lessons as required.
7. Maintaining an adequate stock of required training forms.
8. Assisting the Trg O with keeping track of lessons.
9. Performing other duties as directed by the Trg O.

THIS PAGE INTENTIONALLY LEFT BLANK

TERMS OF REFERENCE—SUPPLY ASSISTANT

Responsible to: Supply Officer (Sup O) / Company Sergeant Major (CSM)

The Supply Assistant is responsible for:

1. Ensuring all equipment is in serviceable condition, noting any deficiencies.
2. Ensuring clothing and equipment is serviceable prior to issue.
3. Ensuring new cadets are promptly kitted following enrolment.
4. Maintaining a unit equipment book showing all equipment, ownership, serial numbers, condition, acquisition and disposal dates and repair history.
5. Ensuring all equipment, especially rifles, are clean prior to storage.
6. Assisting in the issuing and returning of stores.
7. Performing other duties as directed by the Sup O.

THIS PAGE INTENTIONALLY LEFT BLANK

TERMS OF REFERENCE—ADMINISTRATION ASSISTANT

Responsible to: Administration Officer (Adm O) / Company Sergeant Major (CSM)

The Administration Assistant is responsible for:

1. Maintaining an adequate stock of required forms.
2. Preparing all returns, entries in books and records, amendments, unit orders and correspondence as directed by the Adm O.
3. Advising the supply assistant of cadets enrolled and released.
4. Controlling access to relevant publications.
5. Providing reference material to instructional staff.
6. Ensuring conservative use of stationery.
7. Maintaining the orderly room in a clean and tidy manner.
8. Performing other duties as directed by the Adm O.

THIS PAGE INTENTIONALLY LEFT BLANK

FUNCTIONAL ORGANIZATIONAL CHART

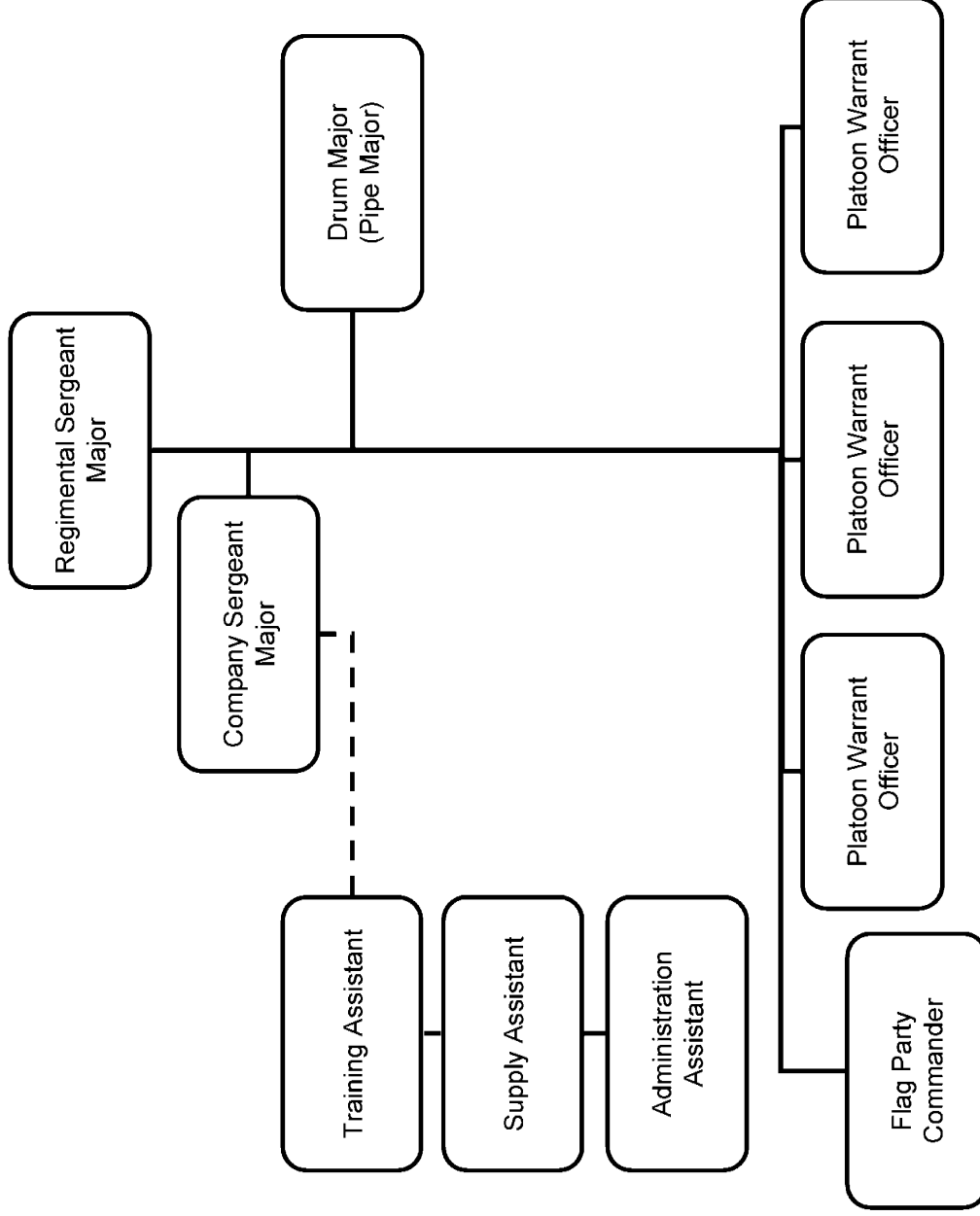

Figure I-1 Functional Organization Chart

Note. Created by Director Cadets 3, 2009, Ottawa, ON: Department of National Defence.

THIS PAGE INTENTIONALLY LEFT BLANK

TERMS OF REFERENCE—STAR LEVEL NCO

Responsible to: Training Officer (Trg O) / Course Officer

The Star Level NCO is responsible for:

1. Performing the duties of a team leader for a star level.
2. Instructing and facilitating star level training.
3. Overseeing and supervising star level training.
4. Informing cadets of upcoming activities and any special training requirements for activities.
5. Advising the Course Officer on progress of each cadet.
6. Ensuring cadets follow timings and lessons.
7. Contributing recommendations for promotions and awards.
8. Performing other duties as directed by the Trg O or the Course Officer.

THIS PAGE INTENTIONALLY LEFT BLANK

TERMS OF REFERENCE—DRILL AND CEREMONIAL INSTRUCTOR

Responsible to: Training Officer (Trg O) / Regimental Sergeant Major (RSM)

The Drill and Ceremonial Instructor is responsible for:

1. Performing the duties of a team leader for drill.
2. Instructing drill.
3. Monitoring drill instruction.
4. Planning drill demonstrations for special events and ceremonies.
5. Acting as a subject matter expert for drill.
6. Conducting parades practices under the supervision of the RSM.
7. Conducting drill demonstrations.
8. Setting the example in dress, drill and deportment.
9. Performing other duties as directed by the Trg O or the RSM.

THIS PAGE INTENTIONALLY LEFT BLANK

TERMS OF REFERENCE–EXPEDITION INSTRUCTOR

Responsible to: Training Officer (Trg O)

The Expedition Instructor is responsible for:

1. Performing the duties of a team leader during expedition training.
2. Assisting in the preparation and planning of expedition training.
3. Participating in and leading expeditions using a variety of modes of travel (eg, canoeing, mountain biking, hiking).
4. Performing field maintenance on expedition equipment (eg, mountain bikes, stoves, tents, expedition field packs, water filters).
5. Instructing and facilitating expedition training.
6. Overseeing and supervising expedition training.
7. Performing other duties as directed by the Trg O.

THIS PAGE INTENTIONALLY LEFT BLANK

TERMS OF REFERENCE–FITNESS AND SPORTS INSTRUCTOR

Responsible to: Training Officer (Trg O)

The Fitness and Sports Instructor is responsible for:

1. Performing the duties of a team leader during fitness and sports activities.
2. Assisting in the preparation and planning of the fitness and sports program.
3. Mentoring cadets in regards to healthy living.
4. Participating in fitness and sports activities.
5. Performing maintenance on sports equipment.
6. Instructing and facilitating fitness and sports training.
7. Organizing and supervising fitness and sports training.
8. Coaching and refereeing fitness and sports activities.
9. Performing other duties as directed by the Trg O.

THIS PAGE INTENTIONALLY LEFT BLANK

TERMS OF REFERENCE–MUSIC INSTRUCTOR

Responsible to: Band Officer (Band O)

The Music Instructor is responsible for:

1. Assisting with the management of the band.
2. Conducting music for the band.
3. Instructing private music lessons.
4. Analyzing and interpreting styles of music.
5. Assisting with the warming up and tuning of the band sections.
6. Organizing the music library.
7. Issuing and receiving inventory.
8. Supervising members of a set-up and tear-down crew.
9. Supervising members of a section / ensemble.
10. Instructing sectional and / or ensemble rehearsals.
11. Providing feedback on overall performance(s).
12. Giving direction to the cadets on how to perform the music.
13. Performing other duties as directed by the Band O.

Note. This terms of reference is for a music instructor in a pipe band or a military band.

THIS PAGE INTENTIONALLY LEFT BLANK

TERMS OF REFERENCE—AIR RIFLE MARKSMANSHIP INSTRUCTOR

Responsible to: Training Officer (Trg O) / Range Safety Officer (RSO)

The Air Rifle Marksmanship Instructor is responsible for:

1. Leading air rifle marksmanship and biathlon activities.
2. Organizing cadets into marksmanship relays.
3. Assisting the RSO.
4. Ensuring the air rifle range is set up and dismantled.
5. Inspecting air rifle marksmanship equipment.
6. Maintaining air rifle marksmanship equipment.
7. Distributing air rifle marksmanship equipment.
8. Enforcing range safety.
9. Scoring and analyzing targets.
10. Coaching and assisting cadets during air rifle marksmanship activities.
11. Employing the firing point sequence.
12. Reinforcing the principles of air rifle marksmanship.
13. Instructing air rifle marksmanship lessons.
14. Performing other duties as directed by the Trg O or the RSO.

THIS PAGE INTENTIONALLY LEFT BLANK

TRAINING ORGANIZATIONAL CHART

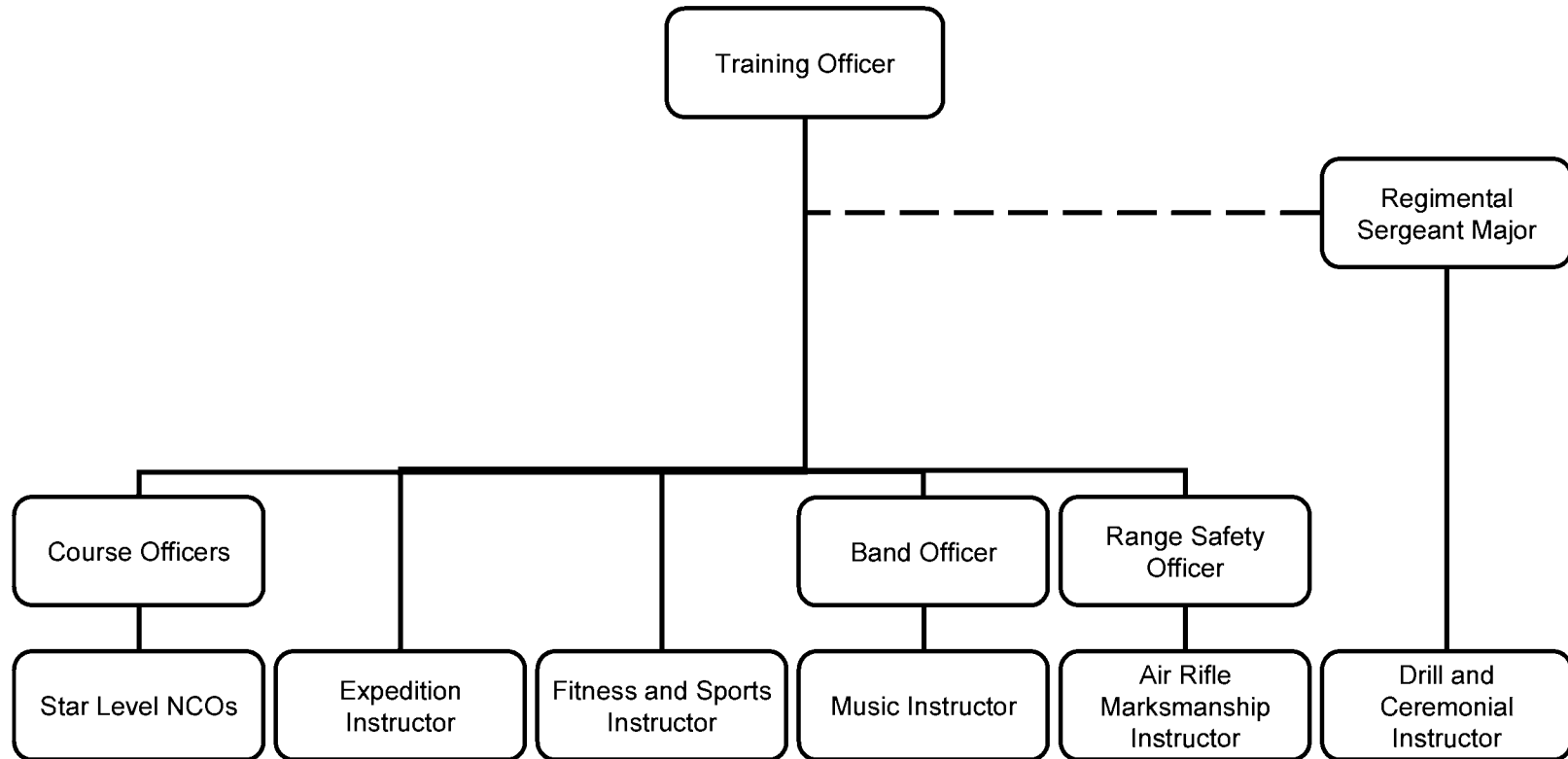

Figure P-1 Training Organization Chart

Note. Created by Director Cadets 3, 2009, Ottawa, ON: Department of National Defence.

Note 1. The Training Officer is responsible for all training matters pertaining to the cadet corps.

Note 2. The Course Officers, Band Officer, Range Safety Officer and Regimental Sergeant Major are responsible for matters pertaining to their area of training.

Note 3. A solid line depicts a direct chain of command and a dashed line depicts an indirect chain of command.

THIS PAGE INTENTIONALLY LEFT BLANK

TERMS OF REFERENCE–DUTY NCO

Responsible to: Duty Officer (Duty O) / Regimental Sergeant Major (RSM)

The Duty NCO is responsible for:

1. Supervising cadets as they arrive.
2. Ensuring all classrooms are open before the start of lessons.
3. Ensuring attendance is taken and handed in.
4. Greeting guests on their arrival and directing them to location.
5. Calling absent cadets.
6. Ensuring cadets that are late are added to the attendance.
7. Ensuring lessons start and end on time.
8. Supervising canteen break and cleanup of area.
9. Supervising cadets on evening cleanup.
10. Completing a final sweep of the area to ensure cleanliness.
11. Picking up and removing any items left behind after training.
12. Ensuring all areas of the building are clean.
13. Ensuring lights are off; doors and windows are closed and locked.
14. Supervising cadets while they wait for rides and depart.
15. Reporting to the Duty O upon the completion of duties.
16. Performing other duties as directed by the Duty O.

THIS PAGE INTENTIONALLY LEFT BLANK

TERMS OF REFERENCE–DUTY ASSISTANTS

Responsible to: Duty Officer (Duty O) / Duty NCO

The duty assistants are responsible for:

1. Assisting the Duty NCO in their duties, to include:
 - a. ensuring all classrooms are open before the start of lessons;
 - b. greeting guests on their arrival;
 - c. supervising cadets during canteen break and cleanup of area;
 - d. supervising cadets on evening cleanup;
 - e. picking up and removing any items left behind; and
 - f. ensuring all areas of the building are clean.
2. Performing other duties as directed by the Duty O or the Duty NCO.

THIS PAGE INTENTIONALLY LEFT BLANK

DUTY ORGANIZATIONAL CHART

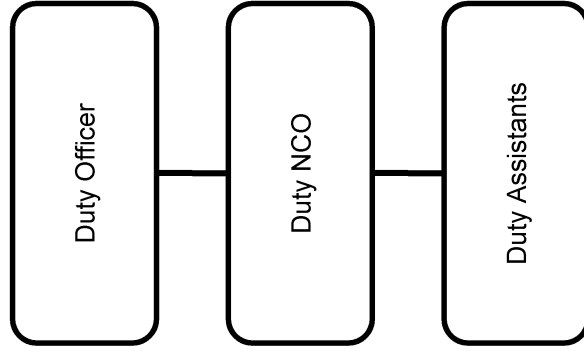

Figure S-1 Duty Organization Chart

Note. Created by Director Cadets 3, 2009, Ottawa, ON: Department of National Defence.

THIS PAGE INTENTIONALLY LEFT BLANK

ACTIVITY SCENARIO

Corps Structure

| Functional Organization | Training Organization |
|---|--|
| Regimental Sergeant Major (RSM). CWO Anderson | Star Level Non-Commissioned Officers (NCOs). WO Lee, WO Lopez and Sgt Singh |
| Company Sergeant Major (CSM). MWO Pelletier | |
| Platoon Warrant Officer (PI WO). WO Lee and WO Lopez | Drill and Ceremonial Instructor. WO Taylor |
| Drum Major (DM). MWO Clark | Expedition Instructor. Sgt Campbell |
| Flag Party Commander (Flag Party Comd). Sgt Williams | Fitness and Sports Instructor. Sgt Brown |
| Training Assistant. WO Martin | Music Instructor. WO Wilson |
| Supply Assistant. Sgt Li | Air Rifle Marksmanship Instructor. WO Chan |
| Administration Assistant. Sgt O'Reilly | |

Training Scenario

Refer to the sample training calendar on the following page to determine the following:

1. Which NCO(s) is responsible for organizing and conducting each activity?
2. Which NCO(s) is required to assist / support the other NCO(s) in some way for each activity?
3. Which NCO(s) is responsible for supervising each activity?
4. As the NCO responsible for organizing and conducting each activity, how would this be accomplished in order to make each activity successful for everyone involved?
5. As the NCO responsible for supervising each activity, how would this be accomplished in order to make each activity successful for everyone involved?

| <i>Sun</i> | <i>Mon</i> | <i>Tue</i> | <i>Wed</i> | <i>Thu</i> | <i>Fri</i> | <i>Sat</i> |
|------------------------------|--|------------|---|------------|------------|----------------------------------|
| | April | | 1 COs Parade (with guest speakers) | 2 | 3 | 4 Air Rifle Training |
| 5 Band Practice | 6 | 7 | 8 Parade Night (Star level training) | 9 | 10 | 11 |
| 12 | 13 | 14 | 15 Parade Night (Star level testing) | 16 | 17 | 18 Expedition Trg Weekend |
| 19 Expedition Trg Weekend | 20 | 21 | 22 Sports Night | 23 | 24 | 25 Community Service Activity |
| 26 | 27 Administration and Supply Night (Prep for ACR) | 28 | 29 ACR Practice | 30 | | |

Figure T-1 Sample Training Calendar

Note. Created by Director Cadets 3, 2009, Ottawa, ON: Department of National Defence.

ACTIVITY SCENARIO ANSWER SHEET

| DATE | ACTIVITY | NCO(s) RESPONSIBLE FOR ORGANIZING AND CONDUCTING | NCO(s) TO ASSIST / SUPPORT | NCO SUPERVISING |
|--------------------|------------------------------------|---|--|--------------------------------|
| April 1 | COs Parade (with guest speakers) | CWO Anderson (MWO Clark, for the band) | All NCOs | N/A |
| April 4 | Air Rifle Training | WO Chan | Sgt Li (for equipment) | N/A |
| April 5 | Band Practice | WO Wilson | N/A | MWO Clark |
| April 8 | Parade Night (star level training) | WO Martin | WO Lee, WO Lopez and Sgt Singh (star levels) Sgt Li and Sgt O'Reilly (supply and admin) | CWO Anderson and MWO Pelletier |
| April 15 | Parade Night (star level testing) | WO Martin | WO Lee, WO Lopez and Sgt Singh (star levels) Sgt Li and Sgt O'Reilly (supply and admin) | CWO Anderson and MWO Pelletier |
| April 17-19 | Expedition Training Weekend | Sgt Campbell | WO Martin (training) and Sgt Li (for equipment) | MWO Pelletier |
| April 22 | Sports Night | Sgt Brown | Sgt Li (for equipment) | WO Martin |
| April 25 | Community Service Activity | CWO Anderson | N/A | N/A |
| April 27 | Administration and Supply Night | Sgt Li and Sgt O'Reilly | N/A | MWO Pelletier |
| April 29 | ACR Practice | WO Taylor | All NCOs | CWO Anderson |

Note: Answers for questions 4 and 5 may vary.

THIS PAGE INTENTIONALLY LEFT BLANK



**COMMON TRAINING
GOLD STAR
INSTRUCTIONAL GUIDE**



SECTION 4

EO C407.01 – PREPARE FOR A MERIT REVIEW BOARD

Total Time:

90 min

PREPARATION

PRE-LESSON INSTRUCTIONS

Resources needed for the delivery of this lesson are listed in the lesson specification located in A-CR-CCP-704/PG-001, *Gold Star Qualification Standard and Plan*, Chapter 4. Specific uses for said resources are identified throughout the instructional guide within the TP for which they are required.

Review the lesson content and become familiar with the material prior to delivering the lesson.

Prepare to conduct merit review boards IAW CATO 13-02, *Cadet Rank Promotions*.

The practice merit review board in TP 3 should be composed of adults who have competent interview skills (eg, officers, civilian instructors, volunteers). Senior cadets should only be used as a last resort.

Obtain the materials for conducting a merit review board for a promotion interview.

Prepare interview questions, marking sheets and candidate scoring sheets (to be created locally) for TP 3.

Arrange for assistant instructors for TP 3.

Obtain a copy of CATO 13-02, *Cadet Rank Promotions*, for each member of the merit review board for promotion.

Photocopy Attachments A, B and D for each cadet.

Photocopy the Merit Review Board Scoresheet located at Attachment C (the number of photocopies will vary based on the number of board members and Gold Star cadets).

Using Attachment B as a guide, prepare the Merit Review Board Scoresheets by deciding on six questions to ask during the practice merit review board.

PRE-LESSON ASSIGNMENT

Nil.

APPROACH

An interactive lecture was chosen for TPs 1 and 2 to present preparations for merit review boards and to summarize the teaching points.

An in-class activity was chosen for TP 3 as it is an interactive way to provoke thought and stimulate interest among the cadets about merit review boards.

INTRODUCTION

REVIEW

Nil.

OBJECTIVES

By the end of this lesson the cadet shall be expected to prepare for a merit review board.

IMPORTANCE

It is important for cadets to prepare for a merit review board to help them succeed in gaining opportunities through competitive application processes.

Teaching Point 1**Identify occasions for a merit review board.**

Time: 5 min

Method: Interactive Lecture

Merit review boards are a structured interview where candidates are evaluated by a group of board members. Candidates are scored on their dress, deportment and answers given to interview questions. Merit review boards are most often conducted for promotion to Master Warrant Officer (MWO) and Chief Warrant Officer (CWO). They provide selection recommendations that are fair and open, and provide candidates with valuable constructive feedback on their performance.

PROMOTIONS REQUIREMENTS

CATO 13-02, *Cadet Rank Promotions*, is the authority for this training.

A merit review board is required to be promoted to MWO and CWO. Promotion merit review boards have many benefits for the corps, to include:

- giving the cadet incentive to learn details of the rank or appointment responsibilities;
- ensuring that the best cadet is selected; and
- satisfying all members of the corps that the best available cadet is leading them.

OTHER POSSIBLE OCCASIONS FOR A MERIT REVIEW BOARD**Awards**

Some corps may conduct a merit review board for important awards. Most often, recommendations for awards are made by a board of staff members who are familiar with the work of all cadets. In all cases, recommendations are given to the Commanding Officer (CO). The CO is the final arbiter of awards.

Scholarships

Scholarship cadets are often selected by the person or entity that is providing the scholarship funding. Corps may choose to hold a merit review board for such a purpose.

Senior Appointments Within the Corps

Some corps may conduct a merit review board for certain appointments within the corps. Most often corps will conduct a workshop or seminar for senior cadets at the beginning of the training year. During this time a merit review board may be conducted for senior appointments within the corps such as Company Sergeant Major (CSM) and Regimental Sergeant Major (RSM).

Cadet Summer Training Centre (CSTC) Training Opportunities

When a corps has multiple excellent cadets for a limited number of course spaces, selection of cadets must be done in an open manner. The CO requires recommendations that are both unbiased and clearly seen to be unbiased. While staff members can and often do provide effective recommendations, the merit review board provides an unbiased option.

Expedition Opportunities

Following the completion of Gold Star, cadets will have the opportunity to apply to attend regional and national (domestic and international) expeditions. The CO may conduct a merit review board prior to submitting the cadet's application to ensure that they meet the expedition requirements. The region may choose to conduct a merit review board to select cadets for expedition positions.

Staff Appointments at the CSTC

When staff cadets arrive at a CSTC prior to the start of summer training, they may be interviewed by a board. This usually takes one of two forms:

- cadets are interviewed by a panel of officers to determine which CSTC position they are most suited for; and
- senior cadets are interviewed by a merit review board for CSM and the RSM positions.

In either case, the interview skills learned at a corps will prove vital to the cadet.

CONFIRMATION OF TEACHING POINT 1

QUESTIONS:

- Q1. What are two important benefits of merit review boards?
- Q2. What are five occasions in which a cadet might encounter a merit review board?
- Q3. What benefit does a corps get from holding promotion merit review boards?

ANTICIPATED ANSWERS:

- A1. Merit review boards have two important benefits:
- providing selection recommendations that are fair and open; and
 - providing cadets with a valuable life skill.
- A2. A cadet might encounter a merit review board for:
- promotions,
 - awards,
 - scholarships,
 - senior appointments within the corps,
 - CSTC training opportunities,
 - expedition opportunities, and
 - staff appointments at the CSTC.
- A3. Promotion merit review boards have many benefits for the corps, to include:
- giving the cadets incentive to learn details of the rank or appointment responsibilities;
 - ensuring that the best cadet is selected; and
 - satisfying all members of the corps that the best available cadet is leading them.

Teaching Point 2**Describe how to prepare for a merit review board for promotion and tips for a successful interview.**

Time: 20 min

Method: Interactive Lecture

HOW TO PREPARE FOR A MERIT REVIEW BOARD FOR PROMOTION

A cadet for a merit review board for promotion should:

- think about potential questions that could be asked and prepare answers to them;
- talk to others who have been through the process to find out what to expect; and
- participate in any opportunity to practice for a board, such as practice merit review boards.

Dress Requirements

The interview cadet shall identify dress requirements ahead of time. The uniform must be worn in accordance with the cadet dress instructions in the relevant Cadet Administration and Training Order (CATO). Dress shall be maintained to a high standard.



Arriving properly dressed to a merit board, or even a civilian interview is critical. The way in which the interviewee is dressed may influence the interviewer's first impression. One should always present themselves in a clean and tidy manner.

TIPS FOR A SUCCESSFUL INTERVIEW**Importance of Bearing**

Many cadets exhibit high standards of dress and high levels of knowledge. The final selections will be based partly on the winning candidates' bearing.

Unless given other instructions, the cadet will enter facing the board, wearing headdress and salute. Wait until offered a seat and remove headdress when seated.

During the interview, the cadet should avoid doing things that may distract the interviewers, such as:

- biting one's lips;
- squirming;
- scratching;
- chewing gum;
- twisting fingers;
- playing with hair;
- checking the time;
- yawning—make sure to have a good night's sleep before the interview; and
- taking anything into an interview that has any chance of distracting the interviewers.

Hand gestures while speaking may also distract interviewers.

The cadet should sit with an open posture with arms and legs uncrossed.

The members of the board want the cadet to feel comfortable and relaxed. The cadet should try to do so, while maintaining respect and decorum. A confident cadet sits up straight, calmly looking the interviewer straight in the eyes without fidgeting. Nodding or shaking the head does not constitute an answer of any kind. All replies must be verbal.

Cadets must be prepared to introduce themselves.

Remember that the interviewers are also going through a process for which they have made long preparations and to which they attach great importance. The cadet being interviewed is, in many ways, part of a team that includes the interviewers. All members of this team are expected to maintain respect, decorum and friendliness.

When the interview is completed, the cadet should stand, replace headdress, make firm eye contact, salute, and smartly depart the room. The board members may or may not offer to shake hands. The cadet should follow the lead of the board members.

Merit Review Board for Promotion Questions



Distribute a copy of Attachment A to each cadet.

IAW CATO 13-02, *Cadet Rank Promotions*, question areas at a merit review board for promotion may include:

- cadets recounting their achievements through cadet training (eg, corps program, CSTC program);
- cadets explaining what previous positions of leadership they have held (eg, at cadets, at school) and how they performed in related situations;
- personal goals and / or their goals for the corps;
- scenario-based questions that relate to typical corps situations where the candidate shares how they might approach / deal with the situation; and
- achievements outside of the cadet corps setting (eg, at school, in their community, sports teams, extracurricular activities).

Cadets are expected to take their time when formulating answers but the answer should be as direct as possible. They should ask for clarifications when necessary. A comprehensively correct answer, formulated carefully and delivered in a relaxed, friendly manner is best.

If the cadet does not know the answer to a question it is best to say so, in as direct a manner as possible, so the interviewer moves on to another topic where the candidate has better knowledge. This will help minimize both the psychological impact of the missing information and the damage to the candidate's mark. Shoulders must never be shrugged during an interview.



Distribute a copy of Attachment B to each cadet.

CONFIRMATION OF TEACHING POINT 2

QUESTIONS:

- Q1. How will a candidate know which uniform to wear for a merit review board interview?
- Q2. When should a candidate take a seat in an interview?
- Q3. What should candidates say if they do not know the answer to a question?

ANTICIPATED ANSWERS:

- A1. The interview candidate shall identify dress requirements ahead of their interview.
- A2. When offered a seat.
- A3. It is best to say they do not know, in as direct a manner as possible.

Teaching Point 3

Have the cadets participate in a practice merit review board based on the instructions given in TP 2.

Time: 55 min

Method: In-Class Activity



This TP shall take place a minimum of two weeks after the instruction of TPs 1 and 2.

The practice merit review board should be composed of adults who have competent interview skills (eg, officers, civilian instructors and volunteers). Senior cadets should only be used as a last resort.

ACTIVITY

OBJECTIVE

The objective of this activity is to have the cadets participate in a practice merit review board.

RESOURCES

- Annex B of CATO 13-02, *Cadet Rank Promotions*,
- Merit Review Board Scoresheet,
- Dress Inspection Scoresheet, and
- Pens / pencils.

ACTIVITY LAYOUT

- In a quiet room:
 - place a table and a chair for each board member and one chair facing the merit review board for the candidate;
 - arrange the lighting to provide the interviewers with a good view of the candidate; and
 - ensure the candidate's back faces toward any window or opening, to avoid distraction.

- Arrange a holding area for cadets prior to their interview.
- Arrange a separate holding area for cadets following their interview.
- Arrange for a messenger to bring each candidate for their interview as directed by the merit review board.

ACTIVITY INSTRUCTIONS

1. Prior to the commencement of the practice merit review boards:
 - a. show the practice merit review board members to their room;
 - b. ensure that each practice merit review board member has the required resources;
 - c. distribute the Merit Review Board Scoresheet to each merit review board member;
 - d. assign a question(s) to each merit review board member to ask during the practice merit review board;
 - e. assign a merit review board member to inspect each cadet using the Dress Inspection Scoresheet;
 - f. introduce the messenger to the practice merit review board;
 - g. explain that the board members will tell the messenger when to bring each cadet; and
 - h. explain that cadets will be guided to a separate holding area after being interviewed.
2. Conduct the practice merit review boards by:
 - a. having the messenger bring a cadet into the room;
 - b. having the assigned merit review board member inspect the cadet;
 - c. having the cadet report to the merit review board and sit down;
 - d. introducing the cadet to the members of the merit review board;
 - e. explaining to each cadet how the merit review board will be conducted; asking if the cadet has any questions prior to asking interview questions;
 - f. having the merit board review members ask their pre-assigned questions;
 - g. having the merit board review members score the cadet based on their answers and take notes using the Merit Review Board Scoresheet;
 - h. debriefing the cadet on their performance and providing them with a copy of their Merit Review Board Scoresheets; and
 - i. having the messenger bring the cadet into the separate holding room prior to bringing in the next cadet.
3. Upon completion of the practice merit review boards;
 - a. thank the members of the practice merit review board for their time and effort; and

- b. debrief the cadets by providing feedback, focusing on:
- (1) best practices,
 - (2) general trends and key areas for improvement, and
 - (3) re-motivation, highlighting the effort and accomplishments of the group.

SAFETY

Nil.

CONFIRMATION OF TEACHING POINT 3

The cadets' participation in the activity will serve as the confirmation of this TP.

END OF LESSON CONFIRMATION

The cadets' participation in the practice merit review board will serve as the confirmation of this lesson.

CONCLUSION

HOMEWORK / READING / PRACTICE

Have the cadets prepare for a merit review board.

METHOD OF EVALUATION

Nil.

CLOSING STATEMENT

Effective preparation for merit review boards will help to obtain important opportunities. These skills will also prove invaluable throughout life.

INSTRUCTOR NOTES / REMARKS

When scheduling this lesson, allow at least two weeks between TPs 2 and 3.

REFERENCES

A0-126 CATO 13-02 Director Cadets 3. (2008). *Cadet rank promotions*. Ottawa, ON: Department of National Defence.

A2-028 CATO 46-01 Director of Cadets 4. (2005). *Army Cadet dress instructions*. Ottawa, ON: Department of National Defence.

C0-416 Air Cadet League of Canada BC Committee (2009). *Sponsoring committee resources: Mock boards*. Retrieved March 4, 2009, from http://www.aircadetleague.bc.ca/SponCommResources/Mock_Boards.PDF

THIS PAGE INTENTIONALLY LEFT BLANK

EXAMPLE QUESTIONS TO EXPECT AT A MERIT REVIEW BOARD FOR PROMOTION

Question areas may include:

- your achievements through cadet training (eg, corps program, CSTC program);
- previous positions of leadership held (eg, at cadets, at school) and your performance in related situations;
- personal goals and / or your goals for the corps;
- achievements outside of the cadet corps setting (eg, at school, in the community, sports teams, extra-curricular activities), and
- scenario-based questions that relate to typical corps situations and how you might approach / deal with the situation.

All candidates will be asked the same questions, which could be similar to the following examples:

- Describe your current corps responsibilities.
- Describe your involvement in corps teams, band and drill, flag party or clubs.
- What leadership positions have you held in any organization?
- What do you consider your strengths / weaknesses are?
- If you had to change something about yourself, what would it be?
- How did you become interested in the cadet movement?
- On an average evening, how much time do you dedicate to homework?
- For what do you use your home computer (eg, games, research, emails)?
- Where are you headed in life?
- Do you plan to take any post-secondary school education?
- What discipline or education do you wish to pursue?
- Do you have a part-time job and, if so, does it compete with cadets or school?
- What community related-activities do you participate in?
- What targets have you set for your personal growth or improvement?
- Do you participate in any organized school teams / groups (eg, band, football)?
- Are you involved with any citizenship activities in your community outside of cadets?
- Do you have any hobbies?
- Scenario-based questions:
 - You have been given responsibility for a group of cadets, some of whom require motivation in uniform care. What will you do?
 - You are in charge of drill instruction and one of your assistant instructors keeps touching cadets when correcting them, despite your instructions to not touch. What do you do?

THIS PAGE INTENTIONALLY LEFT BLANK

PREPARATION FOR A MERIT REVIEW BOARD FOR PROMOTION

A candidate for a merit review board for promotion should:

- think about potential questions that could be asked and prepare answers to them;
- talk to others who have been through the process to find out what to expect; and
- participate in any opportunity to practice for a board, such as practice merit review boards.

Dress Requirements

The interview candidate shall identify dress requirements well ahead of time. The uniform must be worn in accordance with the cadet dress instructions in the relevant Cadet Administration and Training Order (CATO). Dress shall be maintained to a high standard.

TIPS FOR A SUCCESSFUL INTERVIEW

Importance of Bearing

Many candidates will exhibit high standards of dress and high levels of knowledge. The final selections will be based partly on the winning candidates' bearing.

Unless given other instructions, the candidate will enter facing the board, wearing headdress, and salute. Wait until offered a seat and remove headdress when seated.

During the interview, do nothing that may distract the interviewers, such as:

- biting one's lips;
- squirming;
- scratching;
- chewing gum;
- twisting fingers;
- playing with hair;
- checking the time;
- yawning—make sure to have a good night's sleep before the interview; and
- taking anything into an interview that has any chance of distracting the interviewers.

Hand gestures while speaking will also distract interviewers, making a negative impression.

Sit with an open posture and legs and arms not crossed.

The members of the board want the cadet to feel comfortable and relaxed. Try to be so, while maintaining respect and decorum. A confident candidate will sit up straight, calmly looking the interviewer straight in the eye without fidgeting. Nodding or shaking the head does not constitute an answer of any kind. All replies must be verbal.

Candidates must be prepared to say some introductory words about themselves.

Remember that the interviewers are also going through a process for which they have made long preparations and to which they attach great importance. The candidate being interviewed is, in many ways, part of a team

which includes the interviewers. All members of this team are expected to maintain respect, decorum and friendliness.

When the interview is completed, stand, replace headdress, make firm eye contact, salute, and smartly depart the room. The board members may or may not offer to shake hands. Follow their lead.

If the candidate does not know the answer to a question it is best to say so in as direct a manner as possible so the interview moves on to another topic where the candidate has better knowledge. This will minimize both the psychological impact of the missing information and the damage to the candidate's mark. Shoulders must never be shrugged during an interview.



MERIT REVIEW BOARD SCORESHEET



Cadet's Name: _____

Date: _____

| Question | Score | Comments |
|----------|-------|----------|
| 1. | /5 | |
| 2. | /5 | |
| 3. | /5 | |
| 4. | /5 | |
| 5. | /5 | |
| 6. | /5 | |
| Total | /30 | |

Additional Comments:

Board Member's Name: _____

Board Member's Signature: _____

THIS PAGE INTENTIONALLY LEFT BLANK

DRESS INSPECTION SCORESHEET

Cadet's Name: _____

Date: _____

| Uniform Items / Accessories | Score | Comments |
|---|--------------|-----------------|
| HEADRESS | | |
| Beret and Insignia (includes other headdress) | /5 | |
| CLOTHES ON THE UPPER BODY | | |
| Badges (proper placement and sewn on correctly) | /5 | |
| Cadet Slip-on or Armlet | /5 | |
| Shirt, Cadet, Short Sleeve / Turtleneck Sweater | /5 | |
| Uniform Jacket and Belt | /5 | |
| Name Tag | /5 | |
| CLOTHES ON THE LOWER BODY | | |
| Trousers and Belt | /5 | |
| FOOTWEAR | | |
| Parade Boots (with socks) | /5 | |
| OVERALL PERSONAL APPEARANCE | | |
| Hair (includes facial hair) | /5 | |
| Makeup, Jewellery, Sunglasses, etc | /5 | |
| Total | /50 | |

Note. Additional comments may be recorded on the back of the checklist

THIS PAGE INTENTIONALLY LEFT BLANK



**COMMON TRAINING
GOLD STAR
INSTRUCTIONAL GUIDE**



SECTION 1

EO M408.01 – DISCUSS COMMANDING A PLATOON ON PARADE

Total Time:

30 min

PREPARATION

PRE-LESSON INSTRUCTIONS

Resources needed for the delivery of this lesson are listed in the lesson specification located in A-CR-CCP-704/PG-001, *Gold Star Qualification Standard and Plan*, Chapter 4. Specific uses for said resources are identified throughout the instructional guide within the TP for which they are required.

Review the lesson content and become familiar with the material prior to delivering the lesson.

Photocopy CATO 46-01, *Army Cadet Dress Regulations*, for every three cadets, for reference during the group discussion.

PRE-LESSON ASSIGNMENT

Nil.

APPROACH

A group discussion was chosen for this lesson as it allows the cadet to interact with their peers and share their knowledge and opinions about commanding a platoon on parade. Sharing in the discussion encourages the cadet to examine their own thoughts and feelings and may prompt them to re-examine their previously held ideas. Participating in a group discussion improves the cadet's listening skills and team development.

INTRODUCTION

REVIEW

Nil.

OBJECTIVES

By the end of this lesson the cadet shall have discussed commanding a platoon on parade.

IMPORTANCE

It is important for cadets to discuss commanding a platoon on parade in a professional and confident manner as their performance can influence the cadets within the platoon. It is important to be aware of the key attributes required to successfully command a platoon while on the parade square, such as maintaining a high standard of appearance, presence and bearing.

Teaching Point 1**Discuss commanding a platoon on parade.**

Time: 25 min

Method: Group Discussion

BACKGROUND KNOWLEDGE



The point of the group discussion is to draw the following information from the group using the tips for answering / facilitating discussion and the suggested questions provided.



Gold Star cadets will be given opportunities to fill various parade appointments (eg, Platoon Commander, Platoon Warrant). The term team leader has been used throughout this EO to encompass any position.

COMMANDING A PLATOON ON PARADE

The aim of drill is to contribute to the operational effectiveness of the Cadet Program. This aim can be achieved by ensuring cadets march and manoeuvre on the parade square as one unit and by promoting discipline, alertness, precision, pride and the cohesion necessary for success.

Communicating Effectively

As the team leader, there will be various occasions when effective communication will be required, such as when:

- communicating drill commands; and
- speaking to the platoon, in a more informal way.

When speaking to cadets in a platoon, clear and positive communication is necessary to aid in achieving the aim of drill. Profanity, personal sarcasm or negative comments shall never be used.

When calling drill commands, the team leader must develop and use a vocabulary of short, concise words to impress on the platoon that the movement must be performed smartly. When communicating or referring to drill commands and movements, words to use could include:

- sharp,
- crack,
- drive,
- seize, and
- grasp.

Sharp drill movements are dependent on the words of command being properly delivered. Words of command are to be pronounced clearly and distinctly, with confidence and determination, since they convey an order which is to be promptly obeyed.



When correcting errors, the team leader is to address the cadet in a positive tone. The most effective way to correct errors is to explain and demonstrate the correct method and then have the cadet(s) complete the movement(s) the correct way while being observed. This allows the cadet to learn from their error(s).

Executing Sharp Personal Drill

Team leaders must execute all drill movements confidently, correctly and smartly. The characteristics of drill are efficiency, precision and dignity and these qualities are developed through self-discipline and practice.

Team leaders who display constant proficiency in drill are recognized throughout the Cadet Program as highly trained, well-disciplined and professional. Well executed drill develops individual pride, mental alertness, precision and esprit-de-corps. It also sets the standard for the completion of parades and builds a sense of confidence between the team leader and cadet that is essential to high morale.

Maintaining Dress IAW Dress Instructions

Team leaders shall be well groomed with footwear cleaned and shone. The uniform shall be clean and properly pressed at all times.

Dress instructions help ensure a positive image and a high standard of dress are consistent among all cadets when in uniform. Showcasing a high standard of personal dress, appearance and grooming will aid in exhibiting confidence and reflect that the team leader has knowledge of the dress instructions.



Refer to CATO 46-01, *Army Cadet Dress Regulations* for further information on dress standards.

Exhibiting a Positive Attitude

Team leaders should always exhibit a positive attitude toward the members of the platoon while on the parade square because a positive attitude will encourage the cadets to want to follow the example set by the team leader.

The positive attitude taught and developed on and off the parade square must be maintained by the team leader at all times.

Conducting Oneself in an Appropriate Manner

As the team leaders are expected to set the example for the platoon, it is important to project an image of discipline and self-control.

Chewing gum, slouching, sauntering, placing hands in pockets and similar deportment that detracts from a proud and orderly appearance are unacceptable for team leaders.



The appearance, presence and bearing of the team leader must be of the highest standard since this example may be imitated by the cadets within the platoon.

GROUP DISCUSSION



TIPS FOR ANSWERING / FACILITATING DISCUSSION:

- Establish ground rules for discussion, eg, everyone should listen respectfully; don't interrupt; only one person speaks at a time; no one's ideas should be made fun of; you can disagree with ideas but not with the person; try to understand others as much as you hope they understand you; etc.
- Sit the group in a circle, making sure all cadets can be seen by everyone else.
- Ask questions that will provoke thought; in other words avoid questions with yes or no answers.
- Manage time by ensuring the cadets stay on topic.
- Listen and respond in a way that indicates you have heard and understood the cadet. This can be done by paraphrasing their ideas.
- Give the cadets time to respond to your questions.
- Ensure every cadet has an opportunity to participate. One option is to go around the group and have each cadet answer the question with a short answer. Cadets must also have the option to pass if they wish.
- Additional questions should be prepared ahead of time.

SUGGESTED QUESTIONS:

- Q1. What attributes do you expect from a person when they are commanding a platoon? Why?
- Q2. As a member of a platoon, what were some of the positive attributes that you noticed / remembered about your team leader when they were on the parade square?
- Q3. What are some leadership competencies you have noticed in the past as a member of a platoon? What competencies should you exhibit when commanding a platoon on parade?
- Q4. Have you ever commanded a platoon on parade? If so, what did you learn from this experience(s)? What went well when you commanded a platoon on parade? What did not go well when you commanded a platoon on parade?
- Q5. Why is it important to communicate effectively to the cadets within the platoon when commanding a platoon on parade?
- Q6. Why is it important to exhibit a positive attitude when commanding a platoon on parade?
- Q7. Why is it important, as a team leader, to maintain a positive attitude and a high standard of dress?



Write the mentioned / discussed topics on a flip chart and display them for the cadets so they can refer to them.



Other questions and answers will develop throughout the group discussion. The group discussion should not be limited to only those suggested.



Reinforce those answers given and comments made during the group discussion, ensuring the teaching point has been covered.

CONFIRMATION OF TEACHING POINT 1

The cadets' participation in the group discussion will serve as the confirmation of this TP.

END OF LESSON CONFIRMATION

The cadets' participation in the group discussion will serve as the confirmation of this lesson.

CONCLUSION

HOMEWORK / READING / PRACTICE

Nil.

METHOD OF EVALUATION

Nil.

CLOSING STATEMENT

When assigned to command a platoon on parade it is important to conduct oneself with professionalism and confidence. A team leader who portrays a high standard of appearance, presence and bearing positively affects how cadets conduct themselves and respond to orders that are given on the parade square.

INSTRUCTOR NOTES / REMARKS

Nil.

REFERENCES

A0-002 A-PD-201-000/PT-000 Director History and Heritage 3-2. (2005). *The Canadian Forces manual of drill and ceremonial*. Ottawa, ON: Department of National Defence.

A2-028 CATO 46-01 Director Cadets 4. (2005). *Army Cadet dress instructions*. Ottawa, ON: Department of National Defence.

THIS PAGE INTENTIONALLY LEFT BLANK



**COMMON TRAINING
GOLD STAR
INSTRUCTIONAL GUIDE**



SECTION 2

EO M408.02 – IDENTIFY PARADE SEQUENCE

Total Time:

30 min

PREPARATION

PRE-LESSON INSTRUCTIONS

Resources needed for the delivery of this lesson are listed in the lesson specification located in A-CR-CCP-704/PG-001, *Gold Star Qualification Standard and Plan*, Chapter 4. Specific uses for said resources are identified throughout the instructional guide within the TP for which they are required.

Review the lesson content and become familiar with the material prior to delivering the lesson.

Photocopy the parade sequence from A-CR-CCP-701/PF-001, *Green Star Instructional Guides*, Chapter 8, Section 13, Annex A, PO 108 (Participate in an Annual Ceremonial Review [ACR] Parade), to distribute during TP 2 to each cadet.

Photocopy the ACR sequence from A-CR-CCP-701/PF-001, *Green Star Instructional Guides*, Chapter 8, Section 13, Annex D, PO 108 (Participate in an ACR Parade) to distribute during TP 3 as a reference for every three cadets.

Review any regional orders regarding conducting ACR parades.

PRE-LESSON ASSIGNMENT

Nil.

APPROACH

An interactive lecture was chosen for this lesson to orient the cadet to the parade sequences of a parade night and an ACR.

INTRODUCTION

REVIEW

The review for this lesson is from EO M408.01 (Discuss Commanding a Platoon on Parade).

QUESTIONS:

- Q1. What are some examples of communicating effectively when commanding a platoon on parade?
- Q2. What attributes should a cadet demonstrate when commanding a platoon on parade?
- Q3. What are some important aspects of your dress to follow / maintain when commanding a platoon on parade?

ANTICIPATED ANSWERS:

- A1. When speaking to cadets in a platoon, clear and positive communication is necessary to aid in achieving the aim of drill. When commanding a platoon on parade, the team leader must develop and use a vocabulary of short, concise words to impress on the platoon that the movement must be performed smartly.
- A2. Some of the attributes would include:
- communicating effectively;
 - executing sharp personal drill;
 - maintaining dress IAW dress instructions;
 - exhibiting a positive attitude; and
 - conducting oneself in an appropriate manner.
- A3. Team leaders shall be well groomed with footwear cleaned and shone. The uniform shall be clean and properly pressed at all times.

OBJECTIVES

By the end of this lesson the cadet shall have identified the parade sequence of a parade night and an ACR.

IMPORTANCE

It is important for cadets to know the sequence of a parade night's opening and closing parades and an ACR as they will be placed in a team leader role and will need to know the commands, formations and locations of all members on the parade square. Cadets will be looking to their team leader for guidance during a parade night's opening and closing parades and during an ACR.

Teaching Point 1**Discuss the roles of parades within the Cadet Program.**

Time: 5 min

Method: Interactive Lecture



This TP is intended to introduce the many parades that may be conducted within the Cadet Program.



Cadet corps may have specific traditions that they follow for some of their parades.

ROLES OF PARADES WITHIN THE CADET PROGRAM

The purpose of parades is to move cadets in an orderly and efficient manner using precise movements required for displays and ceremonies. Parades also showcase the cadets' knowledge of drill to spectators.

Parade Night

Cadet corps conduct an opening and closing parades most times when they meet for training, as it allows cadets to take attendance, practice drill and inspect uniforms. These parades also provide an excellent opportunity for announcements, presentation of awards and promotions. Opening and closing parades usually follow the ACR sequence, allowing cadets to learn the ACR sequence throughout the training year.

ACR

Each year, cadet corps are required to conduct an ACR parade. The ACR parade provides an opportunity for cadet corps to showcase what they have learned that year and to demonstrate their grasp of drill for family, friends and the community.

Remembrance Day

Every year on November 11, Canadians gather at memorials from coast to coast to remember those who have lost their lives in war or peacekeeping missions. Cities across Canada host Remembrance Day ceremonies and are usually attended by government officials, veterans, serving military members, police, cadets and the general public. At a Remembrance Day ceremony, cadet corps may march in the parade or provide a guard(s) for the cenotaph or memorial.

Special Ceremonial Parades

Special ceremonial parades may be conducted throughout the cadet training year. The following is a list of special ceremonial parades that may be conducted:

- Battle of Britain,
- Battle of the Atlantic,
- Ceremony of the Flags,
- Change of Command,
- Drumhead Ceremony,
- Freedom of the City,

- Military Funeral,
- Retreat and Tattoo,
- Sunset Ceremony, and
- Trooping the Colour(s).

Drill demonstrations may be performed during special ceremonial parades. Standard drill movements must be used at all times.



Refer to A-PD-201-000/PT-000, *The Canadian Forces Manual of Drill and Ceremonial*, for further information on special ceremonial parades.

CONFIRMATION OF TEACHING POINT 1

QUESTIONS:

- Q1. What is the purpose of parades?
- Q2. What two parades are normally conducted on a parade night?
- Q3. Identify some of the special ceremonial parades that may be conducted.

ANTICIPATED ANSWERS:

- A1. The purpose of parades is to move cadets in an orderly and efficient manner using precise movements required for displays and ceremonies. Parades also showcase the cadets' knowledge of drill to spectators.
- A2. Cadet corps conduct an opening and closing parades on a parade night.
- A3. The following is a list of special ceremonial parades that can be conducted:
 - Battle of Britain,
 - Battle of the Atlantic,
 - Ceremony of the Flags,
 - Change of Command,
 - Drumhead Ceremony,
 - Freedom of the City,
 - Military Funeral,
 - Retreat and Tattoo,
 - Sunset Ceremony, and
 - Trooping the Colour(s).

Teaching Point 2**Describe the parade night sequence.**

Time: 10 min

Method: Interactive Lecture



This TP describes the opening and closing parade sequences during a parade night from the view of a team leader commanding a platoon on parade.

Distribute to each cadet a copy of the ACR parade sequence located at A-CR-CCP-701/PF-001, *Green Star Instructional Guides*, Chapter 8, Section 13, Annex A, PO 108 (Participate in an Annual Ceremonial Review [ACR] Parade).

The parade night sequence that is provided in this TP is one way to conduct the parade. Cadet corps have some flexibility regarding their own routines.

PARADE NIGHT SEQUENCE

It is necessary to know and understand the sequence of the opening and closing parades as a team leader commanding a platoon on parade. Team leaders will be required to lead cadets on the parade square through a series of drill commands, formations and movements while effectively communicating.

Opening Parade

The sequence for the opening parade is as follows:

1. **Form up.** Through a series of drill commands, the cadets of the platoon will form up for the opening parade.
2. **Roll call.** Attendance is taken by the team leader to determine if cadets are present, excused or absent.
3. **Inspection.** The inspection can be conducted by the team leader, the Regimental Sergeant Major (RSM) or an officer. In most cases, the team leader conducts the initial inspection of the platoon, before the RSM or an officer conducts the main corps inspection.
4. **March past.** This allows the corps to practice marching for the ACR or any other upcoming parades. As some cadet corps may not have the required space, a march past may not be possible or is not always required.
5. **Announcements.** This is a good opportunity for any announcements, awards, presentations and / or promotions to be given.



Cadet corps may present awards or promotions at the opening parade or the closing parade.

6. **Dismissal.** The dismissal signifies the end of the opening parade and the beginning of the training session(s).

Closing Parade

The sequence for the closing parade is as follows:

1. **Form up.** Through a series of drill commands, the cadets of the platoon will form up for the closing parade.
2. **Announcements.** This is a good opportunity for any announcements, awards, presentations and / or promotions to be given.

3. **Advance in review order.** This allows the corps to practice the advance in review order for the ACR and any other upcoming parades. As some cadet corps may not have the required space, an advance in review order may not be possible or is not always required.



Final compliments to royalty, senior officials and higher military commanders shall be paid after completing the advance in review order.

4. **Dismissal.** The dismissal signifies the end of the closing parade and the end of the training session.



Refer to PO 108 (Participate in an Annual Ceremonial Review [ACR] Parade) Annex A, for further information.

CONFIRMATION OF TEACHING POINT 2

QUESTIONS:

- Q1. How do team leaders lead cadets on parade?
Q2. What is the sequence for the opening parade?
Q3. What is the sequence for the closing parade?

ANTICIPATED ANSWERS:

- A1. Team leaders lead cadets on parade through a series of drill commands, formations and movements while effectively communicating.
- A2. The sequence for the opening parade is as follows:
- form up;
 - roll call;
 - inspection;
 - march past;
 - announcements; and
 - dismissal.
- A3. The sequence for the closing parade is as follows:
- form up;
 - announcements;
 - advance in review order; and
 - dismissal.

Teaching Point 3**Describe the ACR sequence.**

Time: 10 min

Method: Interactive Lecture



This TP is intended to highlight the ACR sequence from the view of a team leader commanding a platoon on parade.

Distribute a copy of the ACR parade sequence located at A-CR-CCP-701/PF-001, *Green Star Instructional Guides*, Chapter 8, Section 13, Annex D, PO 108 (Participate in an Annual Ceremonial Review [ACR] Parade) to every three cadets. This handout outlines the entire format for an ACR parade sequence.

The ACR format that is provided in this TP is one way to conduct the parade. Cadet corps have some flexibility regarding their own routines.

ACR SEQUENCE

The ACR parade provides an opportunity for cadet corps to showcase what they have learned that year and to demonstrate their grasp of drill for family, friends and the community.

Each year, cadet corps are required to conduct an ACR parade. The main sections of the parade sequence for the ACR are as follows:

- form up;
- reception of the reviewing officer (RO);
- inspection by the RO;
- march past;
- awards and presentations;
- advance in review order;
- departure of the RO; and
- dismissal.



Upon completion of the awards and presentations many corps march off the parade square and then conduct demonstrations or displays. The reviewing officer's address normally takes place once the formation has reformed on the parade square after the awards and presentations portion.

CONFIRMATION OF TEACHING POINT 3**QUESTIONS:**

- Q1. How often are cadet corps required to conduct an ACR parade?
- Q2. What is the purpose of an ACR parade?
- Q3. What is the sequence of the ACR parade?

ANTICIPATED ANSWERS:

- A1. Each year cadet corps are required to conduct an ACR parade.
- A2. The ACR parade is an opportunity for cadets to showcase what they have learned that year and to demonstrate their grasp of drill for family, friends and the community.
- A3. The parade sequence for the ACR is as follows:
- form up;
 - reception of the reviewing officer (RO);
 - inspection by the RO;
 - march past;
 - awards and presentations;
 - advance in review order;
 - departure of the RO; and
 - dismissal.
-

END OF LESSON CONFIRMATION

QUESTIONS:

- Q1. What is the purpose of parades?
- Q2. What parade do the opening and closing parade sequences follow?
- Q3. What is the purpose of an ACR parade?

ANTICIPATED ANSWERS:

- A1. The purpose of parades is to move cadets in an orderly and efficient manner using precise movements required for displays and ceremonies. Parades also showcase the cadets' knowledge of drill to spectators.
- A2. Opening and closing parades usually follow the ACR sequence, allowing cadets to learn the ACR sequence throughout the training year.
- A3. The ACR parade is an opportunity for cadets to showcase what they have learned that year and to demonstrate their grasp of drill for family, friends and the community.
-

CONCLUSION

HOMEWORK / READING / PRACTICE

Nil.

METHOD OF EVALUATION

Nil.

CLOSING STATEMENT

When placed in a team leader role it is important to remember that cadets will be looking for guidance and knowledge on the parade square. Team leaders will be expected to guide cadets through a parade night and ACR sequence through a series of drill commands, formations and movements.

INSTRUCTOR NOTES / REMARKS

Nil.

REFERENCES

A0-002 A-PD-201-000/PT-000 Director History and Heritage 3-2 (2005). *The Canadian Forces manual of drill and ceremonial*. Ottawa, ON: Department of National Defence.

THIS PAGE INTENTIONALLY LEFT BLANK



**COMMON TRAINING
GOLD STAR
INSTRUCTIONAL GUIDE**



SECTION 3

EO M408.03 – COMMAND A SQUAD

Total Time:

30 min

PREPARATION

PRE-LESSON INSTRUCTIONS

Resources needed for the delivery of this lesson are listed in the lesson specification located in A-CR-CCP-704/PG-001, *Gold Star Qualification Standard and Plan*, Chapter 4. Specific uses for said resources are identified throughout the instructional guide within the TP for which they are required.

Review the lesson content and become familiar with the material prior to delivering the lesson.

Photocopy and fold in half (laminates if possible) the Parade Sequence Aide-Mémoire Card located at Attachment A for each cadet.

PRE-LESSON ASSIGNMENT

Nil.

APPROACH

A demonstration and performance was chosen for this lesson as it allows the instructor to explain and demonstrate the skill of commanding a squad while providing an opportunity for the cadet to practice the skill under supervision.

INTRODUCTION

REVIEW

The review for this lesson is from EO M408.02 (Identify Parade Sequence).

QUESTIONS:

- Q1. What is the sequence for the opening parade?
- Q2. What is the sequence for the closing parade?
- Q3. What is the general sequence of the Annual Ceremonial Review (ACR) parade?

ANTICIPATED ANSWERS:

A1. The sequence for the opening parade is as follows:

- form up;
- roll call;
- inspection;
- march past;
- announcements; and
- dismissal.

A2. The sequence for the closing parade is as follows:

- form up;
- announcements;
- advance in review order; and
- dismissal.

A3. The general parade sequence for the ACR is as follows:

- form up;
- reception of the reviewing officer (RO);
- inspection by the RO;
- march past;
- awards and presentations;
- advance in review order;
- departure of the RO; and
- dismissal.

OBJECTIVES

By the end of this lesson the cadet shall have commanded a squad.

IMPORTANCE

It is important for cadets to command a squad on parade as they will be placed in a team leader role and will need to know the formations and locations of all members on the parade square. Cadets also need to know how to deliver words of command in a clear and concise manner, with confidence and determination, which will affect how cadets in the squad respond to orders.

Teaching Point 1**Explain, demonstrate and have the cadets command a squad.**

Time: 25 min

Method: Demonstration and Performance



This TP is intended to demonstrate to the cadet how to command a squad. For this skill TP, it is recommended that instruction take the following format:

1. Explain and demonstrate the complete skill of commanding a squad while cadets observe, to include:
 - a. falling in;
 - b. greeting the RO to complete the inspection;
 - c. leading the squad on the march past; and
 - d. falling out.
2. Explain and demonstrate each step required to effectively command a squad while on parade.
3. Have each cadet assume the role of team leader and practice each step.
4. Have each cadet assume the role of team leader and practice the complete skill.

Divide the team into two or three groups, if required, for all cadets to command a squad.

Note: Assistant instructors may be required for demonstration purposes.



Position the cadets around the parade square, as required, so that they can see the movements required to command a squad.



Distribute a copy of the Parade Sequence Aide-Mémoire Card located at Attachment A to each cadet. Cadets may use the card when practicing the skill of commanding a squad.



The term squad is a generic name for a group of cadets, used to teach drill movements. This term can be interchanged with platoon, flight, division or any other applicable elemental or regimental term.

The aim of platoon drill is to enable the platoon, when it takes its place in the company, to carry out any sequence of drill movements that the parade commander orders.



The parade format that is provided in this lesson is one way to conduct the parade. Cadet corps have some flexibility, as they may not have the number of cadets required or cadets may have not completed the required training to assume the role of every parade position.

Refer to Annex A of PO 108 (Participate in an Annual Ceremonial Review Parade), for further information on the parade format.

Falling In

When falling in as a platoon warrant officer (PI WO), follow the required commands of the master warrant officer (MWO) or the deputy parade commander.



If there is no deputy parade commander, the parade commander would complete the required commands and actions.



When assuming the role of a platoon commander (PI Comd), the following additional steps for falling in are to be conducted:

1. The commencement of the promenade begins after the squads have fallen in. The promenade continues until the deputy parade commander or the parade commander is ready to assume command.
2. PI Comds position themselves five paces in the rear of and centred on the deputy parade commander, at the front of the parade square. Dressing is automatic and PI Comds are to stand at ease in succession from the right.
3. On the command OFFICERS FALL—IN, by the deputy parade commander, PI Comds come to attention, turn left and march to their respective squads, approaching their squads from the right flank front (as illustrated in Figure 1).

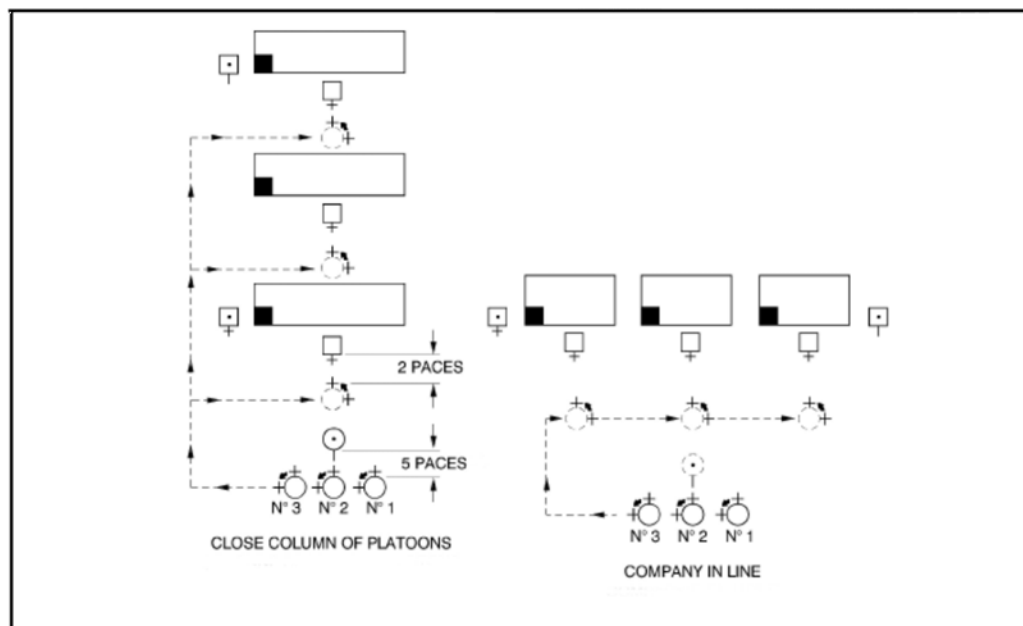

Figure 1 When Officers Fall In

Note. From *The Canadian Forces Manual of Drill and Ceremonial* (p. 7-3-16), by Director History and Heritage 3-2, 2005, Ottawa, ON: Department of National Defence.

4. PI Comds halt two paces in front of the PI WO, who reports the strength, condition, etc, of the squad. PI Comds then march forward two paces to take their proper command position after the PI WO has moved to their position behind the squad.



Figure 1 demonstrates the fall-in procedures when a PI Comd and a PI WO are on parade. Inform the cadets that if no PI Comd is required to fall in, the PI WO will maintain command of the platoon.

Regardless of frontage, when a squad is formed up in line the PI Comd / WO shall be positioned three paces in front and centre of the squad.

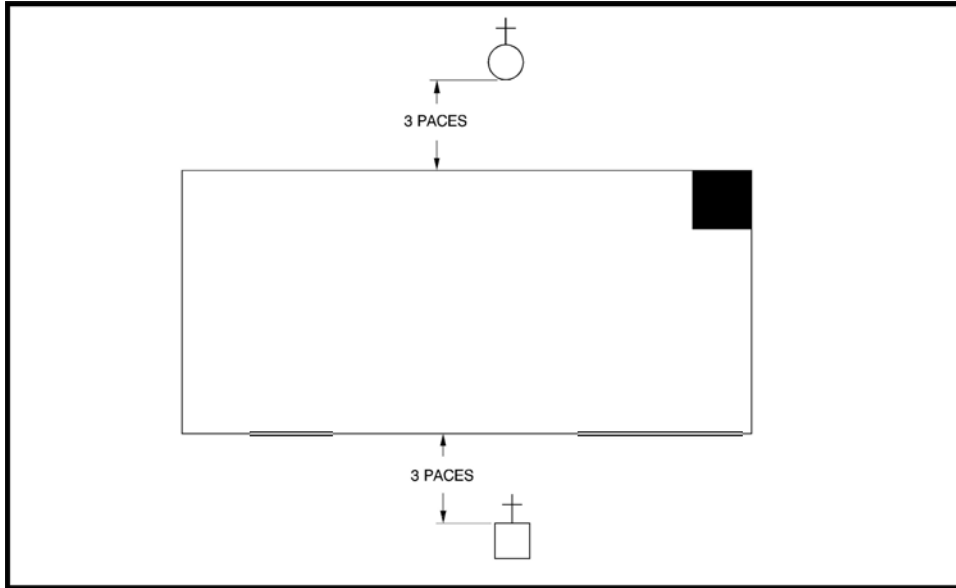

Figure 2 Squad in Line

Note. From *The Canadian Forces Manual of Drill and Ceremonial* (p. 7-2-2), by Director History and Heritage 3-2, 2005, Ottawa, ON: Department of National Defence.





Figure 2 demonstrates the command positions when a PI Comd and a PI WO are on parade.

When on parade, each squad follows the same procedures to hand over command. Once the PI Comd / WO are in their new position(s), the command STAND AT—EASE, is given in succession from the front (right). On the executive word of command of the last PI Comd / WO ordering their squad to stand at ease, PI Comd / WOs turn about and stand at ease together.



Throughout the parade it is important to remember that words of command are to be pronounced clearly and distinctly, with confidence and determination, since they convey an order which is to be promptly obeyed.

Refer to A-CR-CCP-703/PF-001, *Silver Star Instructional Guides*, EO M308.02 (Deliver Words of Command), if further information is required on how to deliver proper words of command.



When paying compliments during the parade, all salutes must be acknowledged and conducted in a sharp manner.

Greeting the RO to Complete the Inspection

Inspections are conducted one squad at a time, normally accompanied by the RO and the reviewing party. The parade commander will give the command NO. 1 SQUAD, STAND FAST, REMAINDER STAND AT—EASE before the inspection begins. The inspection commences with the squad ordered to stand fast.

As the RO approaches, the PI Comd / WO turns right and marches to a position three paces in front of the marker, facing the RO. When the RO approaches, the PI Comd / WO will salute (if required) and report the squad.



The following is an example opening report from the PI Comd / WO to the RO, when the RO approaches the platoon for the inspection.

"Good evening (morning / afternoon) sir (ma'am), Sergeant Jones reporting for number one platoon, 25 cadets on parade, ready for your inspection".



If the RO is a local government official, a civilian or a non-commissioned officer (NCO), a salute is not required.

The PI Comd / WO will guide the RO through the front and rear of each rank, commencing at the right flank of the front rank and proceeding in a counter-clockwise direction around each rank in turn. When the RO has completed the inspection, the PI Comd / WO will position themselves behind the rear rank marker, to acknowledge the RO's completion of the squad's inspection, ask permission to carry on and salute (if required).



The following is an example response from PI Comd / WO to the RO, when the RO has completed the inspection of the platoon.

"Sir (ma'am), thank you for inspecting number one platoon. Permission to carry on?"

Once the RO has begun to move to the next squad, the PI Comd / WO executes a right turn and marches, using a series of wheels, back to their command position facing the squad. When in position the PI Comd / WO shall give the commands CLOSE ORDER—MARCH and STAND AT—EASE. The PI Comd / WO will then turn about to face the front, stand at ease, and await further orders from the parade commander.

As the inspection is being completed, the remaining PI Comds / WOs will observe the RO and as the RO inspects the rear rank of the preceding squad, the next PI Comd / WO shall turn about to face their squad, give the command ATTEN—TION and carry out the inspection sequence for their squad.



Inspections are always carried out at the open order.

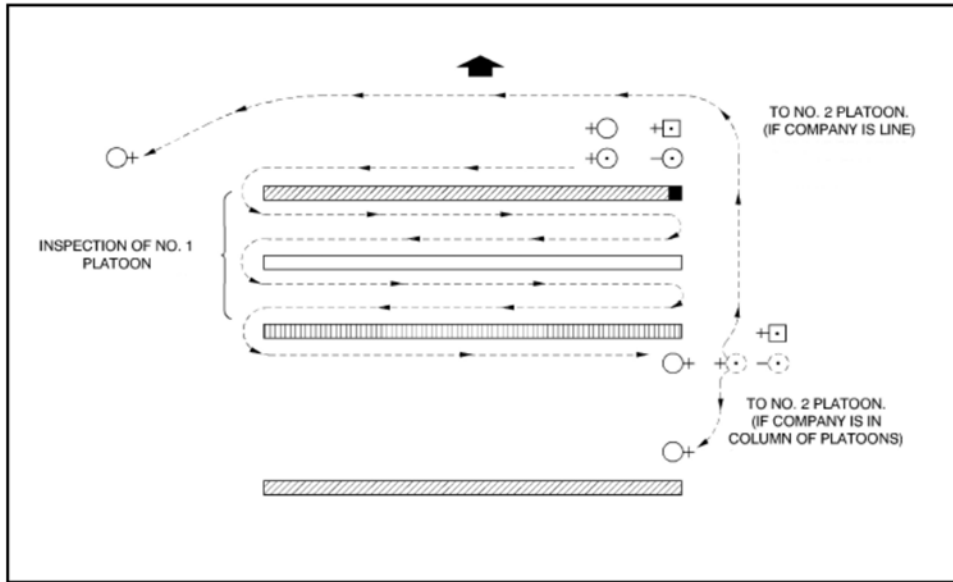



Figure 3 Completing the Inspection

Note. From *The Canadian Forces Manual of Drill and Ceremonial* (p. 7-3-18), by Director History and Heritage 3-2, 2005, Ottawa, ON: Department of National Defence.

Leading the Squad on the March Past

March pasts may be conducted in column of route or in column of threes, depending on time and space available, level of training and the occasion. The simplest march past is column of route in quick time.

Throughout the march past, when commanded by the parade commander, the PI Comd / WO may be required to give the command EYES—RIGHT and EYES—FRONT to their respective squad.

 The commands EYES—RIGHT and EYES—FRONT, will be given on the left foot.

 If there are turns on the march past, the PI Comd / WO may be required to give the commands RIGHT—TURN (called on the left foot) and / or LEFT—TURN (called on the right foot), when directed by the parade commander.

At the end of the march past, the command HALT (called on the left foot) may also be required to be given, when directed by the parade commander.

Column of route. The PI Comd / WO is two paces in front of the centre single file of the squad. Column of route is the formation most commonly used to move squads on the march.

When halted in this position and given the command to turn, the PI Comd / WO will turn in the appropriate direction, observe the standard pause and march, using a series of wheels, to their appropriate position(s).

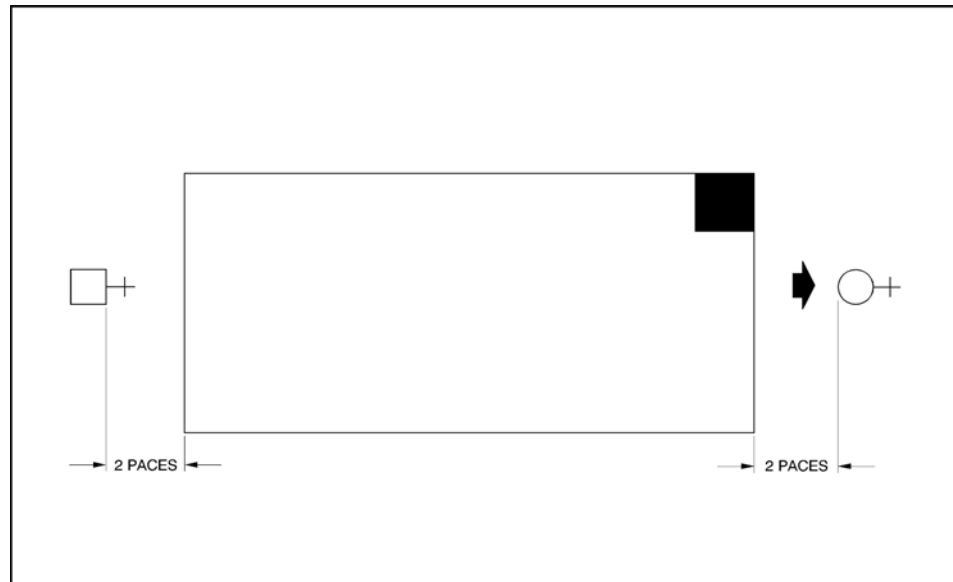

Figure 4 Squad in Column of Route

Note. From *The Canadian Forces Manual of Drill and Ceremonial* (p. 7-2-4), by Director History and Heritage 3-2, 2005, Ottawa, ON: Department of National Defence.



Figures 4 and 5 demonstrate the command positions when a PI Comd and a PI WO are on parade for the march past, in column of route. If there is no PI Comd, the PI WO will command the platoon.

Column of threes. A squad in column of threes is in the same formation as when in line, but facing a flank. Column of threes is another formation used to move a squad on the march.

When halted in this position and given the command to turn, the PI Comd / WO turn in the appropriate direction and maintain their position(s).

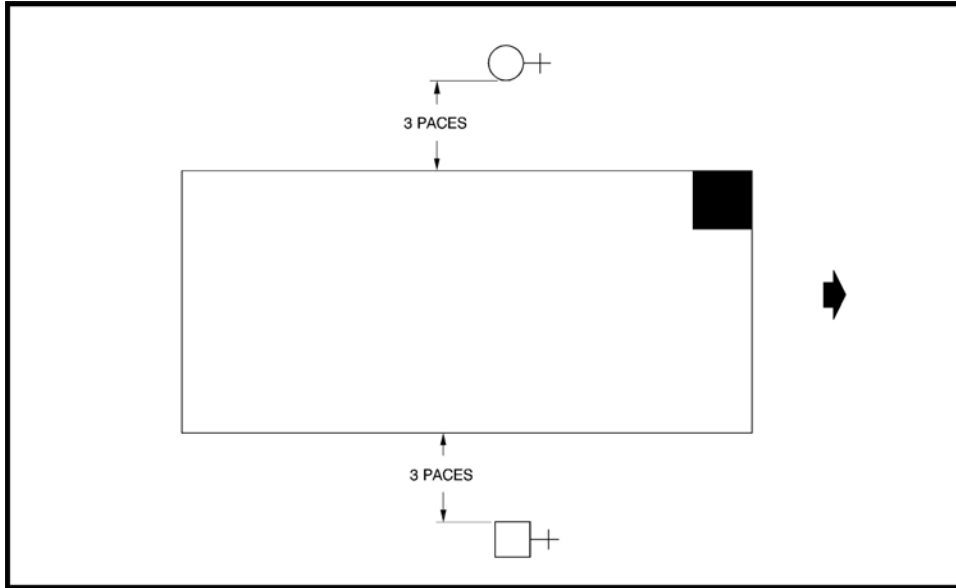



Figure 5 Squad in Column of Threes

Note. From *The Canadian Forces Manual of Drill and Ceremonial* (p. 7-2-3), by Director History and Heritage 3-2, 2005, Ottawa, ON: Department of National Defence.

Falling Out

When falling out as a PI WO, follow the commands of the MWO or the deputy parade commander.



When assuming the role of a PI Comd, the following additional steps of falling out are to be conducted:

1. On the command OFFICERS, FALL—OUT, which is given by the parade commander when the parade is at attention, the PI Comd marches the most direct route and forms up in a line, five paces in front of, centred on and facing, the parade commander, at arm's length interval (without raising the arm), the deputy parade commander on the right.
2. When all PI Comds are present and in line, the deputy parade commander takes a half pace forward.
3. When ordered by the parade commander to DIS—MISS, the deputy parade commander will step back one half pace. All PI Comds will observe the standard pause and march straight forward off the parade square, along with the deputy parade commander.

CONFIRMATION OF TEACHING POINT 1

The cadets' commanding a squad will serve as the confirmation of this TP.

END OF LESSON CONFIRMATION

The cadets' commanding a squad will serve as the confirmation of this lesson.

CONCLUSION

HOMEWORK / READING / PRACTICE

Nil.

METHOD OF EVALUATION

This lesson is assessed IAW A-CR-CCP-704/PG-001, *Gold Star Qualification Standard and Plan*, Chapter 3, Annex B, 408 PC.

CLOSING STATEMENT

Commanding a squad on parade with confidence and determination, will affect how cadets respond to the orders given. Delivering words of command, in a clear and concise manner allows a squad to move as a team in an organized and efficient manner.

INSTRUCTOR NOTES / REMARKS

Where there are a large number of cadets, divide the group into two or three squads and rotate the cadets through as commanders.

REFERENCES

A0-002 A-PD-201-000/PT-000 Director History and Heritage 3-2. (2005). *The Canadian Forces manual of drill and ceremonial*. Ottawa, ON: Department of National Defence.

THIS PAGE INTENTIONALLY LEFT BLANK

PARADE SEQUENCE AIDE-MÉMOIRE CARD



PARADE SEQUENCE AIDE-MÉMOIRE CARD

FALLING IN

When falling in as a PI WO:

Follow the required commands of the MWO or the deputy parade commander.

When falling in as a PI Comd:

1. Stand at ease in succession from the right, once in position.
2. On the command to fall in, come to attention, turn left and march to the platoon, approaching from the right flank.
3. Halt two paces in front of PI WO.
4. March two paces forward (assume the proper command position) and give the command **STAND AT—EASE**.
5. On the executive word of command of the last platoon ordered to stand at ease, turn about and stand at ease.

GREETING THE RO TO COMPLETE THE INSPECTION

1. Ensure the platoon is at attention. Give the command **ATTEN—TION** (if required).
2. Turn right and move to a position three paces in front of the marker (check RO's position as required).
3. Salute the RO (if required) and report the platoon (eg, "Good evening [morning / afternoon] sir [ma'am], Sergeant Jones reporting for number one platoon, 25 cadets on parade, ready for your inspection").
4. Guide the RO through the ranks.
5. After the inspection, stand to attention behind the rear rank marker and salute (if required) and respond to the RO (eg, "Sir [ma'am], thank you for inspecting number one platoon. Permission to carry on?").
6. Execute a turn and march back to the front of the platoon.
7. Give commands **CLOSE ORDER—MARCH** and **STAND AT—EASE** to the platoon.
8. Turn about to face front, stand at ease and await further orders from the parade commander.

LEADING THE PLATOON ON THE MARCH PAST

- Execute all commands given by the parade commander, as per the parade sequence.
- Assume the correct command positions throughout the march past.
- Give the commands **LEFT—TURN** (as required), **EYES—RIGHT**, **EYES—FRONT**, **RIGHT—TURN** (as required) and **HALT** (as required), as directed by the parade commander.

FALLING OUT

When falling out as a PI WO:

Follow the required commands of the MWO or the deputy parade commander.

When falling out as a PI Comd:

- On the command to fall out, march the most direct route and form up in position facing the parade commander.
- On the command to dismiss, observe the standard pause and march straight off parade square.

THIS PAGE INTENTIONALLY LEFT BLANK



**COMMON TRAINING
GOLD STAR
INSTRUCTIONAL GUIDE**



SECTION 4

EO M408.04 – INSPECT A CADET ON PARADE

Total Time:

60 min

PREPARATION

PRE-LESSON INSTRUCTIONS

Resources needed for the delivery of this lesson are listed in the lesson specification located in A-CR-CCP-704/PG-001, *Gold Star Qualification Standard and Plan*, Chapter 4. Specific uses for said resources are identified throughout the instructional guide within the TP for which they are required.

Review the lesson content and become familiar with the material prior to delivering the lesson.

Photocopy CATO 46-01, *Army Cadet Dress Instructions* and the Dress Instructions Activity Worksheet located at Attachment A, for every three cadets.

Photocopy the Dress Instructions Checklist located at Attachment C for each cadet.

PRE-LESSON ASSIGNMENT

Nil.

APPROACH

An in-class activity was chosen for TP 1 as it is an interactive way to provoke thought and stimulate interest and confirm comprehension of elemental dress instructions.

A demonstration and performance was chosen for TP 2 as it allows the instructor to explain and demonstrate the skill of inspecting a cadet on parade while providing an opportunity for the cadet to practice the skill under supervision.

INTRODUCTION

REVIEW

The review for this lesson is from EO M408.03 (Command a Squad).

QUESTIONS:

- Q1. Regardless of frontage, when a squad is formed up in line, how many paces must the platoon commander / warrant officer be positioned when in front and centre of the squad?
- Q2. What is an example report when the reviewing officer (RO) approaches the platoon for the inspection?
- Q3. When commanding the squad as a team leader, what is the team leader responsible for?

ANTICIPATED ANSWERS:

- A1. When a squad is formed up in line the platoon commander / warrant officer shall be positioned three paces in front and centre of the squad.
- A2. "Good evening (morning / afternoon) sir (ma'am), Sergeant Jones reporting for number one platoon, 25 cadets on parade, ready for your inspection".
- A3. When commanding a squad, the team leader is responsible for:
- falling in;
 - greeting the RO to complete the inspection;
 - leading the squad on the march past; and
 - falling out.

OBJECTIVES

By the end of this lesson the cadet shall be expected to inspect a cadet on parade.

IMPORTANCE

It is important for cadets to be able to inspect a cadet on parade as they will be placed in a team leader role and will need to know how to effectively correct errors and evaluate dress, IAW CATO 46-01, *Army Cadet Dress Instructions*. Team leaders must maintain a high standard of appearance and bearing, as cadets will be looking to their team leader for examples, guidance and knowledge when it comes to wearing the elemental cadet uniform.

Teaching Point 1**Conduct an activity where the cadets will, in groups of three, identify the correct way of wearing the cadet uniform.**

Time: 15 min

Method: In-Class Activity



Refer to CATO 46-01, *Army Cadet Dress Regulations* for background information. CATOs can be found online at www.cadets.gc.ca.

ACTIVITY**OBJECTIVE**

The objective of this activity is to have the cadets, in groups of three, identify the correct way of wearing the cadet uniform.

RESOURCES

- Dress Instructions Activity Worksheet located at Attachment A (one per group),
- CATO 46-01, *Army Cadet Dress Instructions* (one per group),
- Dress Instructions Activity Worksheet Answer Sheet located at Attachment B,
- Tables (one per group),
- Chairs (one per cadet), and
- Pen / pencil (one per group).

ACTIVITY LAYOUT

Set up the drill hall or outdoor parade square with tables and chairs for group work, with the required resources for each group to complete their activity worksheet.

ACTIVITY INSTRUCTIONS

1. Divide the cadets into groups of three.
2. Distribute the Dress Instructions Activity Worksheet to each group.
3. Allow each group five minutes to answer the questions on their worksheet.
4. Circulate and assist the cadets as necessary, offering suggestions and advice. Refer to the Dress Instructions Activity Worksheet Answer Sheet, as required.
5. Distribute a copy of CATO 46-01, *Army Cadet Dress Instructions* to each group.
6. Have the cadets, within the group, discuss and confirm their answers from their group activity worksheet.
7. Allow the groups five minutes to check their answers on their worksheet.
8. Review the answers with the class.

SAFETY

Nil.

CONFIRMATION OF TEACHING POINT 1

The cadets' participation in the activity will serve as the confirmation of this TP.

Teaching Point 2

Explain, demonstrate and have the cadets perform an individual inspection.

Time: 35 min

Method: Demonstration and Performance



This TP is intended to demonstrate how to perform an individual inspection and to aid the cadets' comprehension of the inspection process as a team leader. For this skill TP, it is recommended that instruction take the following format:

1. Explain and demonstrate the complete skill of performing an individual inspection while cadets observe, to include:
 - a. inspecting the front of the cadet from head to toe;
 - b. inspecting the back of the cadet from head to toe; and
 - c. correcting errors verbally, as required.
2. Explain and demonstrate each step required to effectively perform an individual inspection.
3. Have each cadet assume the role of team leader and practice each step.
4. Have each cadet assume the role of team leader and practice the complete skill.

Divide the team into two equal groups, if required, for all cadets to assume the role of a team leader inspecting a squad.

Note: Assistant instructors may be employed for demonstration purposes.



This activity will be conducted IAW A-PD-201-000/PT-000, *The Canadian Forces Manual of Drill and Ceremonial*.

Distribute a copy of the Dress Instruction Checklist located at Attachment C to each cadet, as a reference when assuming the role of team leader inspecting a squad.



In this TP, the role of platoon commander is referred to as the team leader.

Inspections shall be carried out at the open order. Ranks shall be dressed after the open order, before the inspection and after the close order. The individual performing the inspection will inspect the front and rear of the rank, commencing at the front rank marker and proceeding in a counter-clockwise direction around each rank in turn.

Ranks that are being inspected are in the position of attention and ranks within the same platoon that are not being inspected, may be ordered to stand at ease. Similarly, during the inspection of one or more squads, the squads that are not being inspected may be ordered to stand at ease. During an inspection, an individual ordered to adjust clothing or equipment shall do so immediately, maintaining their current position within the ranks. After the adjustment is finished, the position of attention will be resumed.

INSPECTING THE FRONT OF A CADET FROM HEAD TO TOE

Inspecting the front of the cadet shall commence at the head and work down to the feet to determine that the cadet:

- is properly equipped for the parade, with clothing and equipment clean and in good repair;
- is properly dressed, with all clothing, badges, ribbons, etc, worn correctly; and
- has a high standard of personal hygiene and grooming.

INSPECTING THE BACK OF A CADET FROM HEAD TO TOE

Inspecting the back of the cadet is done in the same manner as inspecting the front; commence at the head and work down to the feet. The individual performing the inspection is also checking that the cadet is properly dressed and equipped with a high standard of personal hygiene.

CORRECTING ERRORS VERBALLY

Speak to cadets clearly and positively to ensure maximum learning and understanding of the dress instructions.

When correcting errors, the team leader(s) is to address the cadet in a positive tone. Explain and demonstrate the correct method and have the cadet complete the correction (providing it is a minor correction / adjustment that can be done while the cadet is in ranks). This method will allow the cadet to learn from their error(s).



When correcting errors, never touch the cadet. Either ask permission to touch the cadet's uniform or demonstrate how to correct the error using one's own uniform.

CONFIRMATION OF TEACHING POINT 2

The cadets' performance of an individual inspection will serve as the confirmation of this TP.

END OF LESSON CONFIRMATION

The cadets' performance of an individual inspection will serve as the confirmation of this lesson.

CONCLUSION

HOMEWORK / READING / PRACTICE

Nil.

METHOD OF EVALUATION

Nil.

CLOSING STATEMENT

When placed in a team leader role, it is important to remember that cadets will be looking for examples, guidance and knowledge regarding the elemental cadet dress instructions. Team leaders who portray a high standard of appearance and bearing are able to effectively evaluate dress and correct errors in a positive manner.

INSTRUCTOR NOTES / REMARKS

Nil.

REFERENCES

A0-002 A-PD-201-000/PT-000 Director History and Heritage 3-2. (2005). *The Canadian Forces manual of drill and ceremonial*. Ottawa, ON: Department of National Defence.

A2-028 CATO 46-01 Director Cadets 4. (2005). *Army cadet dress instructions*. Ottawa, ON: Department of National Defence.

DRESS INSTRUCTIONS ACTIVITY WORKSHEET

Instructions: Circle TRUE or FALSE for each question. After all questions have been answered, read through CATO 46-01, *Army Cadet Dress Instructions*, to confirm the answers.

| | |
|-----|--|
| 1. | There are three occasions when cadets are permitted to wear their uniforms. |
| | TRUE or FALSE |
| 2. | Cadet medals are worn on the right side of the dress uniform jacket. |
| | TRUE or FALSE |
| 3. | Cadets are not authorized to wear makeup while in uniform. |
| | TRUE or FALSE |
| 4. | An undershirt is allowed to be worn under the uniform, providing it is not visible. |
| | TRUE or FALSE |
| 5. | The double overhand knot is to be used to tie the necktie. |
| | TRUE or FALSE |
| 6. | The Supply Officer is to ensure that the cadets are dressed in accordance with the CATOs. |
| | TRUE or FALSE |
| 7. | The beret shall be worn evenly when positioned on the head. |
| | TRUE or FALSE |
| 8. | The beret is the only headdresses that is authorized to be worn. |
| | TRUE or FALSE |
| 9. | The Remembrance Day poppy is to be placed / pinned and centred on the top left pocket flap of the cadet dress jacket. |
| | TRUE or FALSE |
| 10. | Civilian backpacks must never be carried or worn while in uniform. |
| | TRUE or FALSE |

| |
|--|
| <p>11. Modifications are not permitted on the parade boots.</p> <p>TRUE or FALSE</p> |
| <p>12. The name tag is exactly 7 cm in length.</p> <p>TRUE or FALSE</p> |
| <p>13. The rank insignia shall be worn on the right sleeve of the dress uniform jacket.</p> <p>TRUE or FALSE</p> |
| <p>14. The belt on the dress uniform jacket shall be adjusted so that the excess of the belt is no more than 6 cm.</p> <p>TRUE or FALSE</p> |
| <p>15. The length of the trousers should extend to the 3rd eyelet of the parade boot.</p> <p>TRUE or FALSE</p> |

DRESS INSTRUCTIONS ACTIVITY WORKSHEET ANSWER SHEET

1. There are three occasions when cadets are permitted to wear their uniforms.

ANSWER: TRUE

PARAGRAPH NUMBER: 47 a,b and c

FURTHER INFORMATION: Cadets shall wear their uniform when:

- a. attending training or proceeding to or from a place of training unless directed by the corps CO;
- b. proceeding to or from a CSTC; and
- c. attending ceremonies or functions at which the wearing of uniform is appropriate and authorized by the cadets corps or CSTC CO.

2. Cadet medals are worn on the right side of the dress uniform jacket.

ANSWER: FALSE

PARAGRAPH NUMBER: 84 and 85

FURTHER INFORMATION: Medals shall be worn on the jacket of the uniform and only with the numbered dress C-1, ceremonial dress. Medals shall be suspended above the left breast pocket of the jacket, immediately above and centred. When two or more medals are awarded, they shall be worn in order of precedence, without interval, with the highest priority medal closest to the centre of the chest. Medals shall hang in one row so that they are fully visible. Should this not be possible because of the number being worn, medals shall be overlapped horizontally, the one with the highest priority showing in full. Normally, five or more medals will require overlapping. The maximum width of the mounting is governed by the physique of the individual. The bar shall not project beyond the arm seam of the jacket once the mounting is centred with the jacket pocket.

3. Cadets are not authorized to wear makeup while in uniform.

ANSWER: FALSE

PARAGRAPH NUMBER: 59

FURTHER INFORMATION: Female cadets are authorized to wear a minimal amount of makeup. When wearing a uniform, make-up shall be applied conservatively. This precludes the use of false eyelashes, heavy eyeliner, brightly-coloured eye shadow or lipstick and / or coloured nail polish.

4. An undershirt is allowed to be worn under the uniform, providing it is not visible.

ANSWER: TRUE

PARAGRAPH NUMBER: 31

FURTHER INFORMATION: The undershirt may be worn with any order of dress. The undershirt shall not be visible at the neck opening.

5. The double overhand knot is to be used to tie the necktie.

ANSWER: FALSE

PARAGRAPH NUMBER: 49 I

FURTHER INFORMATION: The necktie shall be knotted neatly using a Windsor or four-in-hand knot and shall be kept tight.

6. The Supply Officer is to ensure that the cadets are dressed in accordance with the CATOs.

ANSWER: FALSE

PARAGRAPH NUMBER: 3

FURTHER INFORMATION: Corps COs shall ensure that their cadets are dressed in accordance with the instructions contained in the CATO.

7. The beret shall be worn evenly when positioned on the head.

ANSWER: TRUE

PARAGRAPH NUMBER: 49 c

FURTHER INFORMATION: The beret shall be worn evenly on the head with the sweatband 2.5 cm above the eyebrows, badge centred over the left eye.

8. The beret is the only headdresses that is authorized to be worn.

ANSWER: FALSE

PARAGRAPH NUMBER: 41

FURTHER INFORMATION: Authorized items are:

- a. Glengarry,
- b. Balmoral,
- c. Forage Cap,
- d. Blue Irish bonnet, and
- e. turban.

9. The Remembrance Day poppy is to be placed / pinned and centred on the top left pocket flap of the cadet dress jacket.

ANSWER: TRUE

PARAGRAPH NUMBER: 82

FURTHER INFORMATION: On the cadet jacket, the poppy shall be pinned and centred on the top left pocket flap or in a similar position on the all-season jacket.

10. Civilian backpacks must never be carried or worn while in uniform.

ANSWER: FALSE

PARAGRAPH NUMBER: 33

FURTHER INFORMATION: Civilian pattern backpacks may either be carried in the left hand or worn suspended from both shoulders and square on the back.

11. Modifications are not permitted on the parade boots.

ANSWER: TRUE

PARAGRAPH NUMBER: 49 n

FURTHER INFORMATION: Boots shall not be modified with any type of metal cleats, hobnails or other metal attachments to heel or sole.

12. The name tag is exactly 7 cm in length.

ANSWER: FALSE

PARAGRAPH NUMBER: 25

FURTHER INFORMATION: The name tag shall be detachable, made of black and white laminated plastic plate, 6.3 cm in length and 1.2 cm in height, inscribed with white lettering 0.6 cm high.

13. The rank insignia shall be worn on the right sleeve of the dress uniform jacket.

ANSWER: TRUE

PARAGRAPH NUMBER: 76

FURTHER INFORMATION: Rank insignia shall be worn on the right sleeve of the dress uniform jacket.

14. The belt on the dress uniform jacket shall be adjusted so that the excess of the belt is no more than 6 cm.

ANSWER: FALSE

PARAGRAPH NUMBER: 49 g

FURTHER INFORMATION: The jacket belt shall be worn so as the excess of the belt, once attached, is on the same side as the buttonhole flap and the excess of the belt is not more than 8 cm.

15. The length of the trousers should extend to the 3rd eyelet of the parade boot.

ANSWER: TRUE

PARAGRAPH NUMBER: 49 h

FURTHER INFORMATION: The length of the trousers should extend to the 3rd eyelet of the boot.

THIS PAGE INTENTIONALLY LEFT BLANK

DRESS INSTRUCTIONS CHECKLIST

CADET'S NAME _____ PLATOON / SECTION _____

| Uniform Items / Accessories | Check (✓) if Item is Clean / Pressed / Polished | Additional Comments |
|---|---|---------------------|
| HEADDRESS | | |
| Beret and Insignia (includes other headdress) | | |
| CLOTHES ON THE UPPER BODY | | |
| Badges (proper placement and sewn on correctly) | | |
| Cadet Slip-on or Armlet | | |
| Shirt, Cadet, Short Sleeve | | |
| Turtleneck Sweater | | |
| Uniform Jacket and Belt | | |
| Necktie | | |
| Name Tag | | |
| CLOTHES ON THE LOWER BODY | | |
| Trousers and Belt | | |
| FOOTWEAR | | |
| Parade Boots (with grey wool socks) | | |
| OVERALL PERSONAL APPEARANCE | | |
| Hair (includes facial hair) | | |
| Makeup, Jewellery, Sunglasses, etc | | |
| PHYSICAL FITNESS GEAR (as required) | | |
| Grey Sports T-Shirt and Shorts | | |
| Running Shoes | | |

Note. Additional comments may be recorded on the back of the checklist.

THIS PAGE INTENTIONALLY LEFT BLANK



**COMMON TRAINING
GOLD STAR
INSTRUCTIONAL GUIDE**



SECTION 5

EO C408.01 – DISCUSS THE HISTORY OF DRILL

Total Time:

30 min

PREPARATION

PRE-LESSON INSTRUCTIONS

Resources needed for the delivery of this lesson are listed in the lesson specification located in A-CR-CCP-704/PG-001, *Gold Star Qualification Standard and Plan*, Chapter 4. Specific uses for said resources are identified throughout the instructional guide within the TP for which they are required.

Review the lesson content and become familiar with the material prior to delivering the lesson.

Photocopy the Summary of Significant Drill Events handout located at Attachment A for each cadet.

PRE-LESSON ASSIGNMENT

Nil.

APPROACH

An interactive lecture was chosen for this lesson to orient the cadets to the history of drill and generate interest.

INTRODUCTION

REVIEW

Nil.

OBJECTIVES

By the end of this lesson the cadet shall have discussed the history of drill.

IMPORTANCE

It is important for cadets to discuss the history of drill as it represents a part of military history. Being able to understand the purpose and evolution of drill will help cadets understand why drill movements are performed by the military today.

Teaching Point 1**Discuss the origins of drill.**

Time: 10 min

Method: Interactive Lecture



This TP is intended to introduce the origin of drill throughout ancient history and how vital drill used was on the battlefield.

Distribute the Summary of Significant Drill Events located at Attachment A to each cadet.

In ancient history, the most powerful, efficient and developed empires developed ways of moving soldiers from one place to another on the battlefield, without individuals getting confused and mixed up with other units. Empires realized that well-drilled soldiers were more efficient in battle.



The earliest known drill movement, during the rise of kingship in Mesopotamia, about 3000 BC, was close-order drill, defined as shoulder to shoulder marching.

At one time, drill and tactics were the same, as drill was needed on the battlefield. Battle drill has existed since ancient times. Separate drill for infantry, armoured, cavalry and others were replaced by all arms drill early in the 20th century, as the changing conditions of war gradually separated tactics from barrack routine.



Infantry. Infantry drill was practiced regularly around 1000 BC and was necessary to ensure that each soldier's movements matched those of the rest.

Armoured. Soldiers, known as armoured spearmen, fought in close-order drill and marched in step to maintain an unbroken shield wall against the enemy. Regular practice was needed to keep the ranks together during battle.

Cavalry. In 875 BC, about a century after the infantry and armoured were developed, a new battlefield tactic (the bow and arrow) was introduced and a new style of warfare drill developed, which resulted in the establishment of the Cavalry. The Cavalry could attack from a distance, with the use of horses. They learned to do drill on the horses, control the horses and aim and shoot their bow and arrow.

Imitation of battle taught the proper use of weapons and strengthened endurance on the battlefield. Armies found that by teaching the soldiers drill and battle procedures, their chances of victory significantly improved.

Drill is still used routinely to move soldiers in an orderly and efficient manner. It also forms the basis of the precise manoeuvres used in military displays and ceremonies.

Romans

Around 2400 BC, Romans realized the way to learn the required skills when deploying for battle was by training Roman soldiers to execute drill in formation. At the beginning of training, recruits were taught the military pace by marching quickly, in time and in formation, up to 32 km (20 miles) a day. Three times a month, garrison soldiers marched 16.1 km (10 miles), built a fortified camp and returned to base, all in the same day. Individual skills with weapons were also developed with daily practice.

Romans spent most of their time practicing ceremonial guard duty and drill, in order to become well-drilled soldiers. The emotional significance of daily and prolonged close-order drill created a lively esprit de corps among the poverty-stricken peasant recruits and the urban outcasts.

The Romans are presumed to have used cadence while marching for tactical formations. Romans regarded military music quite seriously, as they had several warlike instruments. Each soldier had a trumpet, a horn, or both. These were employed for signals, or what is now referred to as “calls”. Instruments were used for marching music and to direct the movement of soldiers.



As Roman soldiers clashed with other armies, they would learn and employ the same sort of successful drill that the other armies had developed.

Greeks and Spartans

Greek citizens did not willingly accept the rigors of military drill, but the emotional effects of keeping together did not disappear when citizen soldiers ceased to dominate military affairs. Drill became more elaborate in the fourth century BC, as those who participated in drill were professional soldiers whose loyalties were to their commanders.

Spartans engaged in drill and marching exercises on a regular basis and learned how to advance evenly into battle by keeping in step to the sound of music, all without breaking their order or ranks. Spartans also learned how to execute flanking movements and open and close order march, allowing their armies to alter the length of their front.



A Spartan is a citizen of Sparta (city in the South Peloponnese) in ancient Greece.



Spartans developed rigorous styles of military training as they required youth to live apart from family, according to their age class in order to participate in physical exercises and military drill.

Chinese

Chinese armies used drummers to beat the drums while soldiers were marching. The drummers would beat the drums once to signify the left foot moving forward and then beat it again to signify the right foot moving forward.

When drill and combat methods were taught, they were taught to 100 men at a time. After instruction to 100 men was complete, they were united with other companies which were comprised of 1 000 men. When the instruction to the 1 000 men was complete, they were combined with other regiments.

Large infantry armies were taught to handle their weapons in unison and maintain formation by keeping in step on the battlefield, all by responding to signals. Most of China's drill movements between 400 and 300 BC were derived from the Romans and the Greeks.



If a drummer missed a beat, he was executed. Those that moved by themselves or did not obey the drums or signals were also executed.

CONFIRMATION OF TEACHING POINT 1

QUESTIONS:

- Q1. In ancient history, why did empires develop ways of moving organized soldiers from one place to another?
- Q2. At the beginning of training, how were Roman recruits taught military pace?
- Q3. Why did Chinese armies use drums?

ANTICIPATED ANSWERS:

- A1. In ancient history, the most powerful, efficient and developed empires developed ways of moving soldiers from one place to another on the battlefield, without individuals getting confused and mixed up with other units.
- A2. At the beginning of training, Roman recruits were taught military pace by marching quickly, in time and in formation, up to 32 km (20 miles) a day.
- A3. Chinese armies used drummers to beat the drums when soldiers were marching. The drummers would beat the drum once to signify the left foot moving forward and then beat it again to signify the right foot moving forward.

Teaching Point 2

Discuss the evolution of drill movements.

Time: 15 min

Method: Interactive Lecture



This TP is intended to describe the evolution of drill and how drill movements and instruction developed throughout the years.

Infantry supremacy and precise drills were eclipsed after the fall of the Roman Empire. During the feudal era, mounted knights ruled combat. Infantry drills were resurrected in the 14th century and slowly developed and improved thereafter.

Swiss

Disciplined soldiers marched in cadence to the sound of musical instruments in admirable order beneath their banners. It is believed that the Swiss, in the late 1300s, were the first modern soldiers to march to music.

Dutch

Words of command were starting to be used for drill shortly after it was introduced to the Dutch in the late 1500s. It became possible to get soldiers to move in unison while performing the actions needed to load, aim and fire their weapons. The soldiers practiced until the necessary motions were almost automatic. This made them less likely to be disrupted by the stress of battle, an advantage when meeting untrained soldiers.

Words of command permitted companies, platoons and squads to respond to their designated leader as different movements and commands were established for units of every size. Soldiers had to practice these movements whenever possible. It was determined that when an entire army was trained this way, control of battle became possible.

In the early 1600s, an artist was used to make engravings of each posture required for each drill movement, with the corresponding words of command below each picture. This material was then gathered and published into a book.

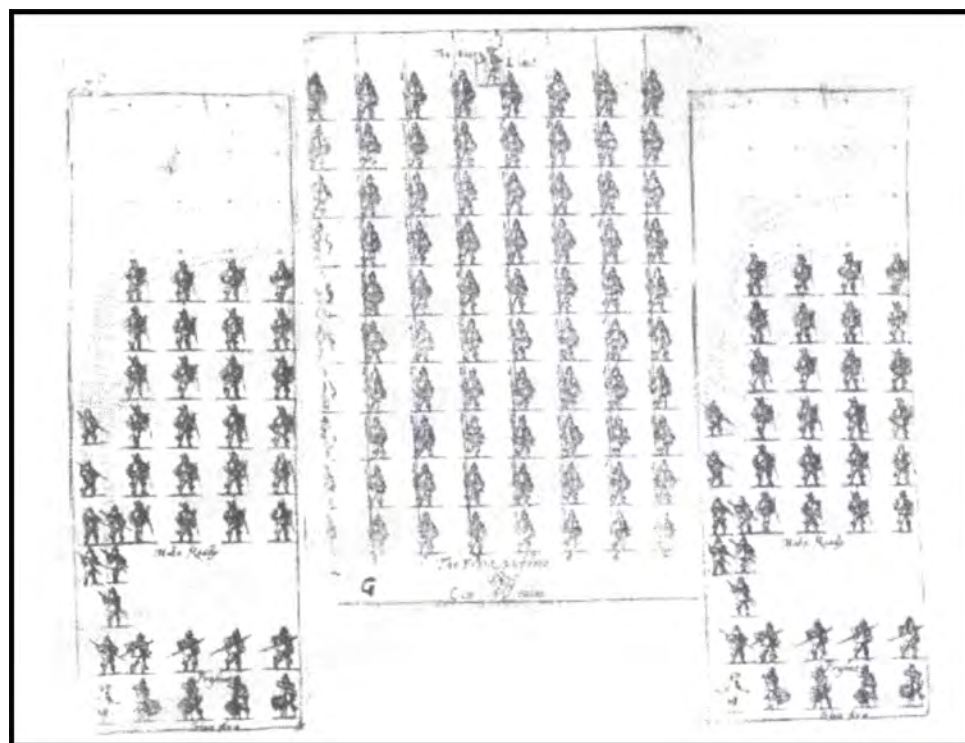

Figure 1 Diagram of a Drill Movement in the 1600s

Note. From *Keeping Together in Time: Dance and Drill in Human History* (p. 86), W. H. McNeill, 1997, Cambridge, MA: Harvard University Press. Copyright 1995 by William H. McNeill.



Over the next half century, the Germans, Russians, Spaniards and French translated the book, causing these drill movements to spread across Europe.

Germans

In the mid 1800s, the Germans (and the Swiss) had the idea of having soldiers become instructors. This provided the opportunity to break down the drill movement(s), demonstrating for all soldiers to see and by allowing the leaders to call out the movements, "by the numbers".



In the late 1800s, the British, Japanese and Chinese followed the Germans and the Swiss by having soldiers teach drill movements.

British

In the British Army, the balance step was a feature of the ordinary march step, experienced today as the slow march. The balance step was introduced as soldiers were required to manoeuvre shoulder to shoulder over rough and uneven ground in disciplined ranks, while giving effective volley fire. Each recruit was trained as a member of a squad until perfect in all points of duty. Each soldier was allowed to join the battalion after being fully trained. Every soldier, after returning from a long absence, had to be re-drilled before being permitted to act in the ranks of his company.

It was imperative that commanders were able to estimate the time required for soldiers to march from point A to point B on foot. With that in mind, the following marches were introduced to the British Army in 1824:

- **March (75 steps per minute, each step 30 inches [76 cm]).** The slowest step (otherwise known as slow time) at which soldiers moved. This march was most commonly used for parades or moving very large formations.
- **Quick march (108 steps per minute, each step 30 inches [76 cm]).** This ordinary pace was applied to most movements by large bodies of soldiers.
- **Wheeling step (120 steps per minute, each step 30 inches [76 cm]).** Wheeling (forming) from line into column or vice versa, ensured there was no delay in achieving the required formation to face a new enemy.
- **Double march (150 steps per minute, each step 36 inches [91 cm]).** This march was applied to the movements within the divisions within a battalion without exhausting soldiers in heavy marching order (eg, load carrying equipment). In rank movements, the double march, when safely applied, may be used in rapid formations, or for quickly moving ranks.

Canadian

- **Royal Canadian Navy.** The Royal Canadian Navy used army drill and ceremonial procedures when on solid ground, by parading as platoons, companies and battalions. While on a ship, the navy conducted ship board drill. The navy still uses the same drill movements while on solid ground; however, they parade by divisions.
- **Canadian Army.** With few exceptions, Canada's Armed Forces used British drill manuals (sometimes with just a Canadian cover and covering page) up until the end of World War II (WW II). It was only with the introduction of a new family of small arms weapons (1989 Draft Drill Manual), and similar developments in other Commonwealth countries, that some of the old drill movements diverged. There were still many similarities in drill, allowing Canadian regiments to execute drill alongside British Army personnel.

One strong influence on the Canadian Forces is the evolution to independent statehood within the British Commonwealth of Nations. This can be seen in customs and routine, uniforms and drill, organization and many other matters (eg, trooping the colours, gun salutes).

- **Royal Canadian Air Force.** Technical requirements of the Royal Canadian Air Force in 1941 called for speeding up the process of drill instruction and, at the same time, reducing the periods of practical training. Both of these objectives were attained by properly combining classroom instruction and parade ground training. The daily program of training was arranged to allow all personnel on strength to receive one hour of classroom instruction and parade ground training per week.

In 1955, the classroom explanation was absent from the *Manual of Drill for the Royal Canadian Air Force*. When conducting drill training, the Royal Canadian Air Force used army drill and ceremonial procedures.



Instructional and practical drill training periods for the Royal Canadian Air Force were as follows:

- classroom instruction—45 percent (demonstration and explanation by instructor);
- practical training—25 percent (on the parade ground);
- mutual instruction—15 percent; and
- voice training—15 percent.



The foot and arms drill of the Royal Canadian Navy, Canadian Army and Royal Canadian Air Force were generally similar, being derived from the same tactical practices. When the three services were unified in 1968, evolution continued by blending the drill detail back into one standard of drill.

CONFIRMATION OF TEACHING POINT 2

QUESTIONS:

- Q1. What did the Dutch create in the early 1600s?
- Q2. What were the marches introduced by the British in 1824?
- Q3. Whose drill manuals did the Canadian Armed Forces use before World War II?

ANTICIPATED ANSWERS:

- A1. In the early 1600s, the Dutch created a book of drill. An artist was used to make engravings of each posture required of each drill movement, with the corresponding words of command below each picture. This material was then gathered and published into a book.
- A2. The following marches were introduced by the British Army in 1824:
- march,
 - quick march,
 - wheeling step, and
 - double march.
- A3. With few exceptions Canada's Armed Forces used British Manuals (sometimes just with a Canadian cover and covering page) up until the end of WW II.

END OF LESSON CONFIRMATION

QUESTIONS:

- Q1. How did the Chinese teach drill to large numbers of soldiers?
- Q2. When did the Dutch start using words of command for drill?
- Q3. Why did the British introduce the balance step?

ANTICIPATED ANSWERS:

- A1. When drill and combat methods were taught, they were taught to 100 men at a time. After instruction to 100 men was complete, they were united with other companies which were comprised of 1 000 men. When the instruction to the 1 000 men was complete, they were combined with other regiments.
- A2. The Dutch started using words of command for drill in the late 1500s.
- A3. The British introduced the balance step because the soldiers were required to manoeuvre shoulder to shoulder over rough and uneven ground in disciplined ranks, while giving effective volley fire.

CONCLUSION

HOMEWORK / READING / PRACTICE

Nil.

METHOD OF EVALUATION

Nil.

CLOSING STATEMENT

Drill procedures and movements are a large component of today's military. Learning about the purpose and evolution of drill will help you understand why so many drill movements are performed within the military today.

INSTRUCTOR NOTES / REMARKS

Nil.

REFERENCES

A0-002 A-PD-201-000/PT-000 Director of History and Heritage 3-2. (2005). *The Canadian Forces manual of drill and ceremonial*. Ottawa, ON: Department of National Defence.

C2-249 ISBN 978-0674-5023-07 McNeill, W. (1997). *Keeping together in time: Dance and drill in human history*. Cambridge, MA: Harvard University Press.

SUMMARY OF SIGNIFICANT DRILL EVENTS

| Date | People | Event |
|----------------|-------------------------------|--|
| 3000 BC | Mesopotamians | The earliest known drill movement was close-order drill (defined as shoulder to shoulder marching). |
| 2400 BC | Romans | Realized the way to learn the required skills when deploying for battle was by training soldiers drill in formation. |
| 1000 BC | Greeks / Romans | Infantry drill was practiced regularly and was very necessary to ensure that each soldier's movements matched those of the rest. Armoured soldiers, also known as spearmen, fought in close-order drill and marched in step to maintain an unbroken shield wall. |
| 875 BC | Greeks / Romans | A new battlefield tactic (the bow and arrow) was introduced and a new style of warfare drill developed, which resulted in the establishment of the Cavalry. The Cavalry could attack from a distance, with the use of horses. They learned to do drill on the horses, control the horses and to aim and shoot their bow and arrow. |
| 400 and 300 BC | Chinese | Most of China's drill movements were derived from the Romans and Greeks. |
| 1300s | Swiss | Were the first modern soldiers to march to music. |
| 1500s | Dutch | The first to use words of command for drill. |
| 1600s | Dutch | An artist made engravings of each posture required for each drill movement, with the corresponding words of command below each picture. This material was gathered and published into a book. |
| mid 1800s | Germans (and Swiss) | Had the idea of having soldiers become instructors. This provided the opportunity to break down the drill movement(s), demonstrating for all soldiers to see and by allowing the leaders to call out the movements, "by the numbers". |
| late 1800s | British, Japanese and Chinese | Followed the Germans and the Swiss by having soldiers teach drill movements. |
| 1824 | British | The balance step (the slow march) was introduced as soldiers were required to manoeuvre shoulder to shoulder over rough and uneven ground in disciplined ranks, while giving effective volley fire. |
| early 1900s | Canadians | Canada's Armed Forces used British drill manuals (sometimes with just a Canadian cover and covering page). |
| 1941 | Canadians | Technical requirements of the Royal Canadian Air Force called for speeding up the process of drill instruction and, at the same time, reducing the periods of practical training. |
| 1955 | Canadians | The classroom explanation was absent from the <i>Manual of Drill for the Royal Canadian Air Force</i> . |
| 1968 | Canadians | The foot and arms drill of the Royal Canadian Navy, Canadian Army and Royal Canadian Air Force were generally similar, being derived from the same tactical practices. When the three services were unified in 1968, drill evolution continued by blending the drill detail back into one. |

THIS PAGE INTENTIONALLY LEFT BLANK



**COMMON TRAINING
GOLD STAR
INSTRUCTIONAL GUIDE**



SECTION 6

EO C408.02 – VIEW A RE-ENACTMENT THAT DEMONSTRATES THE HISTORY OF DRILL

Total Time:

90 min

THERE IS NO INSTRUCTIONAL GUIDE PROVIDED FOR THIS EO

THIS PAGE INTENTIONALLY LEFT BLANK



**COMMON TRAINING
GOLD STAR
INSTRUCTIONAL GUIDE**



SECTION 1

EO M409.01 – IDENTIFY METHODS OF INSTRUCTION

Total Time:

60 min

PREPARATION

PRE-LESSON INSTRUCTIONS

Resources needed for the delivery of this lesson are listed in the lesson specification located in A-CR-CCP-704/PG-001, *Gold Star Qualification Standard and Plan*, Chapter 4. Specific uses for said resources are identified throughout the instructional guide within the TP for which they are required.

Review the lesson content and become familiar with the material prior to delivering the lesson.

Create a slide of Attachment A.

Photocopy and 3-hole punch the handouts located at Attachments B, F, G, and H for each cadet.

Make three copies of the Methods of Instruction Puzzle located at Attachment C for the activity in TP1. The two sheets should be of different colours, Description sheets should be colour A and Typical Application sheets should be colour B.

Prepare the Methods of Instruction Puzzles using the directions located at Attachment C.

Make one photocopy of the methods of instruction information sheets located at Attachment E.

Provide binders for each cadet to collect all work in this performance objective.

PRE-LESSON ASSIGNMENT

Nil.

APPROACH

An in-class activity was chosen for TPs 1 and 2 as it is an interactive way to review previously learned material and confirm the cadets' comprehension of new methods of instruction.

A group discussion was chosen for TP 3 as it allows the cadets to interact with their peers and share their knowledge, experiences, opinions and feelings about the application of various methods of instruction.

INTRODUCTION

REVIEW

Nil.

OBJECTIVES

By the end of this lesson the cadet shall be expected to identify the methods of instruction and select the appropriate method of instruction for a given topic.

IMPORTANCE

It is important for cadets to be aware of the various methods of instruction when filling an instructional role. Being able to select and apply each method will help the cadets prepare and deliver an effective lesson.

Teaching Point 1**Conduct an activity where the cadets will review methods of instruction.**

Time: 10 min

Method: In-Class Activity

ACTIVITY**OBJECTIVE**

The objective of this activity is to review the methods of instruction previously taught in EO M309.02 (Identify Methods of Instruction).

RESOURCES

- Teaching = learning handout located at Attachment A,
- Methods of Instruction worksheet located at Attachment B,
- Methods of Instruction Puzzle located at Attachment C,
- Methods of Instruction Guide Attachment D (for instructor use only),
- OHP,
- Envelopes,
- Binders,
- Pens / pencils,
- Tape, and
- Stopwatch.

ACTIVITY LAYOUT

Place the sample Methods of Instruction Puzzle (located at Attachment C) at the front of the classroom so it is easily accessible to all groups.

Set up two work stations and place the following at each station:

- Methods of Instruction worksheet located at Attachment B for each cadet,
- One envelope with the Method of Instruction Puzzle located at Attachment C, and
- One binder for each cadet.

ACTIVITY INSTRUCTIONS

1. Divide the cadets into two groups.
2. Show the cadets the slide of Attachment A and ask the cadets to:
 - a. determine what the cartoon is implying; and
 - b. consider why varying teaching techniques can assist with learning.

3. Introduce the sample Methods of Instruction Puzzle by:
 - a. pointing out the two top row categories: description and typical applications;
 - b. identifying the first column as the six methods of instruction; and
 - c. explaining the colour coding system by pointing out that all descriptions are colour A and all typical applications are colour B.
4. Have the groups race to complete the Methods of Instruction Puzzle, according to the following rules:
 - a. Groups must place their pieces of the puzzle in the appropriate column and row.
 - b. A group that is having difficulty may visit the sample located at the front of the classroom up to two times.
 - c. A penalty of 30 seconds will be added to a group's time for each visit to the sample.
 - d. The group that completes the puzzle correctly in the least time is the winner.



Attachment B is provided for the cadets who finish the puzzle early. Ask them to make personal notes on each method of instruction. It is not necessary to fully complete the sheet but it will be a useful reference in the future.

SAFETY

Nil.

CONFIRMATION OF TEACHING POINT 1

The cadets' participation in the activity will serve as the confirmation of this TP.

Teaching Point 2

Conduct an activity where the cadets will describe methods of instruction.

Time: 20 min

Method: In-Class Activity

ACTIVITY

OBJECTIVE

The objective of this activity is to introduce the cadets to methods of instruction.

RESOURCES

- Methods of instruction information sheets located at Attachment E,
- Methods worksheet located at Attachment F,
- Presentation aids,
- Markers,

- Pens / pencils, and
- Tape.

ACTIVITY LAYOUT

Set up six learning stations, to include:

- Flip chart paper,
- Markers, and
- Pens / pencils.

ACTIVITY INSTRUCTIONS

1. Write the following on the whiteboard / flip chart:
"Tell me, and I forget;
Show me, I may remember;
Involve me, and I will understand." - Chinese Proverb
2. Ask the cadets the following questions:
 - a. What are some possible meanings of the quote?
 - b. What are the connections between learning and instruction?
3. Divide the class into six groups and assign each group a method of instruction, to include:
 - a. group discussion,
 - b. guided discussion,
 - c. role-play,
 - d. experiential learning,
 - e. problem-based learning, and
 - f. case study.



If the class size is small, divide the class into three groups and assign two methods to each group.

4. Have the groups title the flip chart paper with their given method of instruction.
5. Have the cadets write the following headings on the flip chart paper:
 - a. description,
 - b. applications,
 - c. preparation and development, and
 - d. pros and cons.

6. Have each group brainstorm and record ideas relating to each section of their flip chart paper.
7. Distribute the assigned method of instruction information sheet to each group.
8. Have each group read their method of instruction information sheet and add details to their flip chart paper.



Distribute the Methods worksheet to each cadet.

9. Display charts around the room.
10. Have each group present their method of instruction. Allocate about 1–2 minutes for each group presentation.
11. Instruct the cadets to fill in the Method worksheet, making short notes, as each group presents their method to the class.



It is not necessary for the cadets to fully complete the sheet but it will be a useful reference in the future.

SAFETY

Nil.

CONFIRMATION OF TEACHING POINT 2

The cadets' participation in the activity will serve as the confirmation of this TP.

Teaching Point 3

Conduct a group discussion on the application of methods of instruction.

Time: 20 min

Method: Group Discussion

BACKGROUND KNOWLEDGE



The point of the group discussion is to draw the following information from the group using the tips for answering / facilitating discussion and the suggested questions provided.

Some examples of the types of lessons that lend themselves easily to a specific method of instruction are:

Interactive Lecture. Lessons with facts or dates, including history lessons.

Demonstration and performance. Any drill or skill, such as first aid and rope work.

In-class activity. Lessons that lend themselves easily to using brainstorming, worksheets and group work. This type of lesson is used to reinforce instructional topics such as instructional technique and environmental stewardship.

Practical activity. Map and compass, and cool-down and warm-up activities for sports.

Game. Lessons that include labelling or defining terms and performance-based lessons.

Field trip. Visit an elemental museum, visit an airport or ship, and visit a college to view possible careers.

Group discussion. Benefits of healthy living, qualities of a good leader and environmental issues relevant to Canada.

Guided discussion. Explain personal integrity and explain decision-making processes.

Role-play. Influence behaviours, leadership scenarios, and history.

Experiential learning. Participating in citizenship activities and attending weekend training.

Problem-based learning. Teambuilding activities and leadership styles.

Case study. Characteristics of a leader and various events in history.

GROUP DISCUSSION



TIPS FOR ANSWERING / FACILITATING DISCUSSION:

- Establish ground rules for discussion, eg, everyone should listen respectfully; don't interrupt; only one person speaks at a time; no one's ideas should be made fun of; you can disagree with ideas but not with the person; try to understand others as much as you hope they understand you; etc.
- Sit the group in a circle, making sure all cadets can be seen by everyone else.
- Ask questions that will provoke thought; in other words avoid questions with yes or no answers.
- Manage time by ensuring the cadets stay on topic.
- Listen and respond in a way that indicates you have heard and understood the cadet. This can be done by paraphrasing their ideas.
- Give the cadets time to respond to your questions.
- Ensure every cadet has an opportunity to participate. One option is to go around the group and have each cadet answer the question with a short answer. Cadets must also have the option to pass if they wish.
- Additional questions should be prepared ahead of time.



Attachment G contains a list of possible criteria to consider when choosing methods of instruction. Distribute Attachment G to each cadet before discussing the questions.



Distribute the Method of Instruction Summary handout located at Attachment H. As the methods of instruction are being discussed, the cadets may record ideas for each one on the handout.

To facilitate the discussion, record ideas on a flip chart / whiteboard.

SUGGESTED QUESTIONS:

- Q1. What methods of instruction do you like to participate in most? Why? Provide an example.
- Q2. What methods of instruction were used to instruct this lesson? What evidence do you have?
- Q3. Would you choose a different method of instruction for this lesson? What and why?
- Q4. What criteria do you consider most / least important when choosing a method of instruction? Why?
- Q5. Ask the following questions for each method of instruction:
 1. What is an application of this method?
 2. Why would you choose this method?
 3. Does anyone disagree?
 4. Would this application apply to another method of instruction? Why or why not?
 5. Are there any other lessons that would fall into this method of instruction?



Other questions and answers will develop throughout the group discussion. The group discussion should not be limited to only those suggested.



Reinforce those answers given and comments made during the group discussion, ensuring the teaching point has been covered.

SAFETY

Nil.

CONFIRMATION OF TEACHING POINT 3

The cadets' participation in the group discussion will serve as the confirmation of this TP.

END OF LESSON CONFIRMATION

The cadets' participation in the group discussion will serve as the confirmation of this lesson.

CONCLUSION

HOMEWORK / READING / PRACTICE

Nil.

METHOD OF EVALUATION

This EO is assessed in IAW A-CR-CCP-704/PG-001, *Gold Star Qualification Standard and Plan*, Chapter 3, Annex B, 409 PC.

CLOSING STATEMENT

It is pertinent to have an exposure to the various methods of instruction in order to be flexible as an instructor. Familiarity with these methods may improve the instructor's ability to select activities that are appropriate for lessons. While many lessons may be taught using more than one method of instruction, choosing the most appropriate method of instruction is key.

INSTRUCTOR NOTES / REMARKS

Nil.

REFERENCES

A0-055 A-P9-050-000/PT-006 Director Training and Education Policy. (2002). *Canadian Forces individual training and education system* (Vol. 6). Ottawa, ON: Department of National Defence.

A0-123 A-PD-050-001-PF-001 Chief of Defence Staff. (2001). *Central flying school flight instructors handbook*. Winnipeg, MB: Department of National Defence.

C0-379 Kizlik, R. (2009). *Education Information for new and future teachers*. Retrieved February 26, 2009 from www.adprima.com

THIS PAGE INTENTIONALLY LEFT BLANK

Teaching = Learning?



Figure A-1 Teaching = Learning











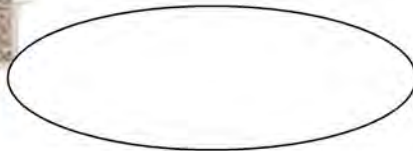
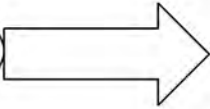

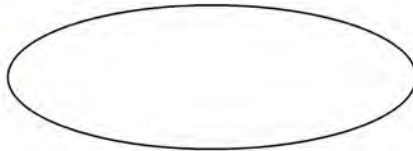
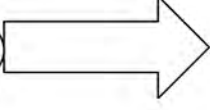
Note: From Tiger Comics by Bud Blake. Retrieved March 10, 2009, from <http://www.kingfeatures.com/features/comics/tiger/about.html>

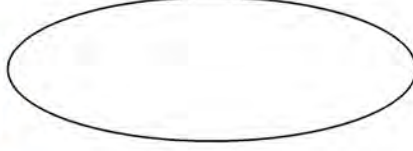
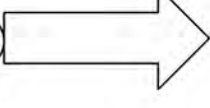
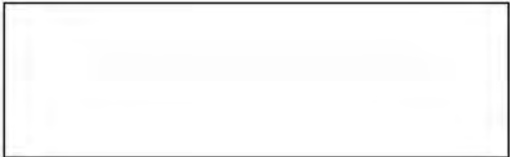
THIS PAGE INTENTIONALLY LEFT BLANK

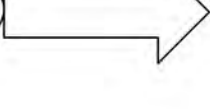
Name: _____

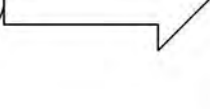
Place 6 methods of instruction in the circles. Then list two characteristics of each.

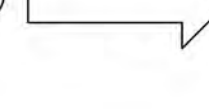
Methods of Instruction

| | | |
|---|---|--|
|  |  |  |
|  |  |  |
|  |  |  |
|  |  |  |
|  |  |  |
|  |  |  |

THIS PAGE INTENTIONALLY LEFT BLANK

METHODS OF INSTRUCTION PUZZLE

Directions

1. Photocopy three copies of Attachment C using coloured paper.



The top right-hand corner of each page indicates the colour paper to be used for each copy. The colours correspond with different sections of the puzzle as illustrated in Figure C-1.

2. Cut out each piece of the puzzle.
3. Refer to Attachment D to help with the assembly of the puzzle.
4. Assemble one puzzle to demonstrate to the class (as illustrated in Figure C-1).

| | Description | Typical Applications |
|-------------------------------|-------------------------------------|-------------------------------------|
| Interactive Lecture | C O L O U R A | C O L O U R B |
| Demonstration and Performance | | |
| In-Class Activity | | |
| Practical Activity | | |
| Game | | |
| Field Trip | | |

Figure C-1 Methods of Instruction Puzzle

Note. Created by Director Cadets 3, 2009, Ottawa, ON: Department of National Defence.

5. Put the other two sets of the puzzle pieces in two envelopes.

| | | |
|---------------------------------------|---|---------------------------------|
| <p>Interactive Lecture</p> | <p>Demonstration and Performance</p> | <p>In-Class Activity</p> |
| <p>Practical Activity</p> | <p>Game</p> | <p>Field Trip</p> |

| | |
|---|--|
| <p style="text-align: center;">DESCRIPTION</p> | <p style="text-align: center;">TYPICAL APPLICATIONS</p> |
|---|--|

DESCRIPTIONS

| | |
|--|--|
| <p>Is used with one or more participants to practice skills, apply strategies, and enhance teams.</p> <p>Supports learning through a challenging activity that allows for skill practice or knowledge confirmation.</p> | <p>A method where theoretical knowledge is reinforced through participation in an activity in a real-life setting.</p> |
| <p>An instructor-driven method that combines both lecture and interaction to meet lesson objectives.</p> <p>Examples include videos with discussion, games, learning stations, brainstorming, debating, group work and the completion of handouts.</p> | <p>This method involves observing the instructor and performing and rehearsing the task under the supervision of the instructor.</p> |

Colour A

DESCRIPTIONS

| | |
|---|--|
| <p>Involves a wide variety of potential activity-based learning that can be used to support learning objectives.</p> <p>Encourages participation.</p> <p>Examples include learning stations, videos, brainstorming, debating, group work, and the completion of handouts.</p> | <p>This method includes a wide variety of activity-based learning opportunities that can be used to introduce new experiences.</p> |
|---|--|

Colour A

TYPICAL APPLICATIONS

| | |
|---|--|
| <p>Used to:</p> <ul style="list-style-type: none"> • introduce a topic; • discover concepts and principles; • learn terminology; • recall terms; • recognize equipment parts; • carry out an application; • confirm learning; or • demonstrate a process. | <p>Used to:</p> <ul style="list-style-type: none"> • introduce / illustrate and confirm topics; • reinforce and clarify classroom learning; • inject variety into the situation; or • allow viewing of operations or equipment that cannot easily be shown in the classroom. |
| <p>Used to:</p> <ul style="list-style-type: none"> • introduce a subject; • present background information; • review previously taught material; • give instructions on procedures; or • illustrate the application of rules, principles or concepts. | <p>Used to:</p> <ul style="list-style-type: none"> • teach hands-on operations or procedures; • teach troubleshooting; • illustrate principles; • teach operation or functioning of equipment; or • teach safety procedures. |

Colour B

TYPICAL APPLICATIONS

| | |
|--|--|
| <p>Used to:</p> <ul style="list-style-type: none">• teach both knowledge and skill lessons;• reinforce instructional objectives;• introduce a subject and generate interest;• give background information;• illustrate application of rules, principles or concepts; or• create interactivity during a lecture. | <p>Used to:</p> <ul style="list-style-type: none">• carry out an application;• demonstrate a process;• verify an explanation;• produce a product;• teach manipulative operations; or• teach procedures. |
|--|--|

Colour B

THIS PAGE INTENTIONALLY LEFT BLANK

METHOD OF INSTRUCTION
Interactive Lecture

| DESCRIPTION | LESSON PREPARATION | TYPICAL APPLICATIONS | LESSON DEVELOPMENT |
|---|---|--|--|
| <p>Interactive lecture is an instructor-driven method that combines both lecture and interaction to meet lesson objectives. The lecture portions of the lesson are offset with relevant activities such as videos with discussion, games, learning stations, brainstorming, debating, group work or the completion of handouts.</p> | <p>Use attention-getters such as interesting facts, statistics or rhetorical questions to begin the lecture or to introduce new teaching points.</p> <p>Prepare participatory questions to encourage cadet participation.</p> <p>Prepare evaluative questions for confirmation of teaching points.</p> <p>Obtain or develop training aids to clarify main points.</p> <p>Prepare an in-class activity to avoid lecturing for too long.</p> <p>Practice delivering the material.</p> | <p>Interactive lectures can be used with different sizes of groups to:</p> <ul style="list-style-type: none"> • introduce a subject; • present background information; • review previously taught material; • give instructions on procedures; • illustrate the application of rules, principles or concepts; or • introduce a demonstration, discussion or performance. | <p>Begin the lesson and each new TP with an attention-getter.</p> <p>Use presentation aids such as:</p> <ul style="list-style-type: none"> • flip chart, • whiteboard, and / or • electronic media. <p>Pay attention to signals of alertness, such as:</p> <ul style="list-style-type: none"> • cadets' facial expressions, and • cadets' body language. <p>Deal with alertness problems by:</p> <ul style="list-style-type: none"> • asking for questions; and • posing questions to the group. <p>Use visual training aids at opportune moments.</p> <p>Integrate interesting facts with lesson material to maintain interest.</p> <p>Use participatory questions or a short activity to avoid lecturing too long.</p> <p>Use questions to confirm each teaching point.</p> <p>Confirm the lesson using questions or an activity.</p> |

METHOD OF INSTRUCTION
Demonstration and Performance

| DESCRIPTION | LESSON PREPARATION | TYPICAL APPLICATIONS | LESSON DEVELOPMENT |
|--|--|---|---|
| <p>Demonstration and Performance</p> <p>During demonstration and performance, the cadets observe the instructor performing the task in a demonstration, and rehearse it under the supervision of the instructor.</p> | <p>The instructor must be skilled in the task.</p> <p>Gather all materials necessary to instruct the lesson.</p> <p>Break the task down into smaller sequential steps.</p> <p>Practice the lesson to ensure that steps are accurate and clear.</p> <p>Prepare a handout outlining the steps, if necessary.</p> <p>Organize the training area so that all cadets can:</p> <ul style="list-style-type: none"> • see the demonstration, and • perform the task. | <p>Demonstration Method</p> <p>Demonstration can be used to:</p> <ul style="list-style-type: none"> • teach hands-on operations or procedures; • teach troubleshooting; • illustrate principles; • teach operation or functioning of equipment; • set standards of workmanship; • explain a theory or concept; or • teach safety procedures. <p>Performance Method</p> <p>Performance can be used to:</p> <ul style="list-style-type: none"> • teach hands-on operations or procedures; • teach operation or functioning of equipment; • teach skills; or • teach safety procedures. | <p>Introduce the lesson by demonstrating what the cadets will be able to do at the end.</p> <p>Explain where the skill can be applied and why it is important.</p> <p>Provide a handout outlining the steps if the process is complex.</p> <p>Explain and demonstrate each step in a sequence.</p> <p>Allow cadets maximum time to practice the steps as soon as possible.</p> <p>Positively reinforce everything the cadets do correctly.</p> <p>Supervise the cadets as they practice, providing assistance or re-demonstrations when necessary.</p> <p>Have cadets perform the skill as confirmation.</p> <p>Encourage the cadets to practice beyond class time.</p> |
| <p>Demonstration Method</p> <p>A method of instruction where the instructor, by actually performing an operation or doing a job, shows the cadet what to do, how to do it and explains why, where and when it is done.</p> <p>Performance Method</p> <p>A method in which the cadet is required to perform, under controlled conditions, the operations, skill or movement being taught.</p> | | | |

METHOD OF INSTRUCTION
In-Class Activity

| DESCRIPTION | LESSON PREPARATION | TYPICAL APPLICATIONS | LESSON DEVELOPMENT |
|--|--|---|--|
| <p>In-class activities encompass a wide variety of activity-based learning opportunities that can be used to reinforce and practice instructional topics or to introduce cadets to new experiences. In-class activities should stimulate interest among cadets and encourage their participation, while maintaining relevance to the performance objectives. Examples of in-class activities include learning stations, videos, brainstorming, debating, and group work.</p> | <p>Create an activity that involves all cadets, which can be conducted within the time allocated.</p> <p>Clearly specify the objective of the activity.</p> <p>Obtain all materials necessary to complete the activity.</p> <p>Write out specific instructions describing what participants are supposed to do.</p> <p>Write out specific directions for conducting the activity.</p> <p>Arrange for assisting staff, if necessary, to help conduct the activity.</p> <p>Prepare handouts for cadets containing background information.</p> <p>Organize the training area into work / learning stations.</p> | <p>An in-class activity can be used for both knowledge and skill lessons to:</p> <ul style="list-style-type: none"> • reinforce instructional objectives; • introduce a subject and generate interest; • present background information; • give direction on procedures; • introduce a demonstration, discussion or performance; • illustrate the application of rules, principles or concepts; • create interactivity during a lecture; or • review, clarify or summarize information. | <p>Introduce the activity to the whole group.</p> <p>Brief participants on what will be expected of them.</p> <p>Stress timings.</p> <p>Ensure all resources are available.</p> <p>Begin the activity.</p> <p>Supervise and assist the groups as required.</p> <p>Conclude the activity.</p> <p>Confirm the TP or lesson.</p> <p>Debrief the cadets.</p> |

METHOD OF INSTRUCTION
Practical Activity

| DESCRIPTION | LESSON PREPARATION | TYPICAL APPLICATIONS | LESSON DEVELOPMENT |
|---|---|---|--|
| <p>Practical activities encompass a wide variety of activity-based learning opportunities that can be used to reinforce and practice skills or to introduce cadets to new experiences. Practical activities should stimulate interest among cadets and encourage their participation, while maintaining relevance to the performance objective.</p> | <p>The instructor must be skilled in the task.</p> <p>Gather all materials necessary to instruct the lesson.</p> <p>Organize the training area so that all cadets will have space to perform the task safely.</p> <p>Ensure there is enough time to conduct the complete activity or breakdown the task into smaller stages.</p> <p>Prepare a handout outlining the steps, if necessary.</p> <p>Arrange for assisting staff, if necessary.</p> <p>Plan for composition of groups.</p> | <p>If it is used to teach new material, it must be combined with other methods to ensure cadets have the necessary background information to complete the activity.</p> <p>The practical activity method can be used to:</p> <ul style="list-style-type: none"> • carry out an application; • demonstrate a process; • verify an explanation; • produce a product; • introduce a subject; • teach manipulative operations; • teach procedures; • teach troubleshooting; • illustrate principles; • teach equipment operation; or • teach safety. | <p>Review background information.</p> <p>Distribute the handout, if necessary.</p> <p>Introduce the activity to the group.</p> <p>Stress safety.</p> <p>Brief the cadets on what they will be expected to do.</p> <p>Brief assisting staff on what they will be expected to do.</p> <p>Begin the activity.</p> <p>Supervise the cadets and provide assistance, if necessary.</p> <p>Watch for safety infractions and stop the activity, if necessary.</p> <p>Conclude the activity.</p> <p>Debrief the cadets.</p> |

METHOD OF INSTRUCTION

Game

| DESCRIPTION | LESSON PREPARATION | TYPICAL APPLICATIONS | LESSON DEVELOPMENT |
|---|---|---|--|
| <p>Games are used with one or more participants to practice skills, apply strategies and enhance teams. It is critical that the game supports learning through a challenging activity that allows for skill practice or knowledge confirmation.</p> | <p>Develop a simple game with the following characteristics:</p> <ul style="list-style-type: none"> • is fast to play; • is easy and quick to organize; • has few rules; • uses minimal equipment; and • involves maximum participation. <p>If possible, use variations of games cadets know from childhood or television.</p> <p>Determine the following when developing the rules of the game:</p> <ul style="list-style-type: none"> • individual or team play, • how to change leaders, • what the leader will do, • what the followers will do, • timings for the game, • how to signal the start and stop of the game, • how to ensure safety. <p>Obtain the resources needed to play the game.</p> <p>Organize the training area to play the game.</p> | <p>Games create variety and arouse interest but must also support learning.</p> <p>Games can be used to:</p> <ul style="list-style-type: none"> • introduce a topic; • discover concepts and principles; • learn terminology; • recall terms; • recognize equipment parts; • develop strategies and tactics; • carry out an application; • demonstrate a process; • practice interpersonal skills; and / or • confirm learning. | <p>Brief the cadets on the following:</p> <ul style="list-style-type: none"> • the objective of the game, and • rules of the game. <p>Play the game.</p> <p>Supervise closely to :</p> <ul style="list-style-type: none"> • ensure that the game is played in the manner expected; • ensure that the game is played safely; and • ensure maximum participation. <p>End the game.</p> <p>Debrief the cadets.</p> |

METHOD OF INSTRUCTION
Field Trip

| DESCRIPTION | LESSON PREPARATION | TYPICAL APPLICATIONS | LESSON DEVELOPMENT |
|--|--|---|--|
| <p>Theoretical knowledge is reinforced through participation in an activity in a real-life setting. Prior planning helps to ensure all pre-training and safety standards are met. Field trip activities are planned and carried out to achieve clear instructional objectives that are understood by the cadets. Examples include trips to areas of local interest, flying / gliding, hiking and / or sailing.</p> | <p>Specify the objective(s) of the field trip.</p> <p>Determine the time and location of the field trip.</p> <p>Obtain necessary authorizations.</p> <p>Determine the timings.</p> <p>Determine the activities or demonstrations needed to achieve the objectives.</p> <p>Determine if trained personnel will be available to assist.</p> <p>Arrange the following, if necessary:</p> <ul style="list-style-type: none"> • transportation, • supervision, and • meals. <p>Determine if the cadets will be allowed to use equipment or participate in a training activity.</p> <p>Determine if all cadets can take part at once or if they need to rotate through.</p> <p>Divide the cadets into groups, if necessary.</p> <p>Ensure safety.</p> | <p>The field trip is used to:</p> <ul style="list-style-type: none"> • introduce / illustrate and confirm topics; • reinforce and clarify classroom learning; • inject variety into the training situation; or • allow cadets to view operations or equipment that cannot easily be shown in the classroom. | <p>Inform cadets as soon as possible of the following:</p> <ul style="list-style-type: none"> • time of the field trip, • location of the field trip, and • timings for departure. <p>Brief cadets on the following prior to departure:</p> <ul style="list-style-type: none"> • objectives of the field trip, • timings and groupings for activities and demonstrations, and • how they will participate during the field trip. <p>During the field trip ensure the following:</p> <ul style="list-style-type: none"> • the safety of all cadets, • maximum participation, and • the objectives are met. <p>After the field trip:</p> <ul style="list-style-type: none"> • debrief the cadets; and • confirm that objectives have been met. <p>Express appreciation to the facilitators of the field trip.</p> |

Guided Discussion

Description:

A method in which learners are guided in steps to reach instructional objectives by drawing out their opinions, knowledge, experience and capabilities, and by building on these to explore and develop new material. Learners discuss issues to expand their knowledge of the subject.

Applications:

- Develop imaginative solutions to problems (eg, through brainstorming).
- Stimulate thinking and interest and secure learner participation.
- Emphasize main teaching points.
- Supplement lectures, reading or laboratory exercises.
- Determine how well learners understand concepts and principles.
- Prepare learners to apply theory or procedure.
- Clarify or review points.
- Determine learner progress and the effectiveness of prior instruction.
- Foster attitudinal change.

Preparation and Development:

Reading material should be provided to learners in advance so that learners are familiar with the concepts that will be discussed.

To begin, an instructor should introduce the topic and scenario; outline the main discussion points; state the what, where and why of the lesson; and create an open environment.

During the body of the lesson, the instructor poses open lead-off questions to guide the discussion toward the aim. The instructor concludes the lesson by reviewing all the main points contributed by both the learner and instructor and by relating points back to the lesson aim.

Advantages:

- Increases cadet interest.
- Increases cadet acceptance and commitment.
- Uses cadet knowledge and experience.
- Results in more permanent learning because of the high degree of cadet participation.

Disadvantages:

- Requires highly skilled instructors to redirect discussion using rephrased comments or summaries.
- Requires preparation by cadets.
- Limits content.
- Consumes time.
- May not accomplish goals.
- Can get off topic.
- Some members may not participate.

Group Discussion

Description:

A method to discuss issues and share knowledge, opinions and feelings about a topic in small groups. The instructor's questioning is flexible and minimal, and encourages reflection on personal experiences and opinions through peer interactions.

Applications:

- Develops imaginative solutions to problems.
- Emphasizes main teaching points.
- Determines individual progress and the effectiveness of prior instruction.
- Prepares individuals for application of theory or procedure.

Preparation and Development:

Prepare an issue or problem that will interest the cadets and stimulate discussion.

Organize cadets into small groups.

Put groups in circles or horseshoes.

Pose a lead-off question and encourage participation of all cadets.

Advantages:

- Increases cadet interest.
- Increases cadet acceptance and commitment.
- Uses cadet knowledge and experience.
- Results in more permanent learning because of the high degree of cadet participation.

Disadvantages:

- Requires highly skilled instructors.
- Requires preparation by cadets.
- Limits content.
- Consumes time.
- Restricts size of group.
- Requires selective group composition.

| Problem-Based Learning | |
|--|--|
| <p>Description: A method that facilitates the learning of principles and concepts by having learners work on solving a problem drawn from the work environment. Instructors must pose thought-provoking questions and guide cadets without influencing their decisions.</p> | |
| <p>Applications: It allows learners to:</p> <ul style="list-style-type: none"> • learn through practicing what they will have to do on the job; • learn by imitating others' behaviour; • learn from the feedback of others; and • learn through practice and reflection on each scenario in which they participate. | |
| <p>Preparation and Development: This method is usually conducted with small groups of 5–7 learners or with pre-established teams. Instructors prepare carefully constructed problems that are realistic. During the lesson, learners analyze the problem and work toward solving it. Instructors facilitate learning by posing questions to get learners thinking and talking (eg, What are the clues, facts and any guesses about the problem and its causes? What other information is needed?). The instructor should ensure that all learners participate because discussion is key to learning, but they should try not to influence decisions. Instructors may also challenge learners' thinking by questioning learners without leading them to the correct answer (eg, What does this mean? What are the implications?).</p> | |
| <p>Advantages:</p> <ul style="list-style-type: none"> • Encourages participation by cadets. • Maintains relevance to performance objectives. • Many resources are involved. • Problems are realistic for learners to relate to. | <p>Disadvantages:</p> <ul style="list-style-type: none"> • Critical thinking skills are required. • Broad knowledge of the subject matter is required. • Instructors must be experienced in facilitating learning. |

Role-Play

Description:

A method of interaction in which learners play out and practice realistic behaviors by assuming specific roles and circumstances.

Applications:

It allows learners to:

- practice responding to various situations that are similar to those they will encounter; and
- develop human interaction skills.

Preparation and Development:

Begin the lesson by clearly explaining the objective of the lesson (what, where, when and why). It is critical to explain that role-playing is a learning process and learners are not expected to play their roles perfectly from the start. This will help put learners at ease.

The instructor must clearly explain each role the learners will play. This is followed by a demonstration of the role-play either on video or through a live performance by instructional staff. Learners are paired or grouped together and the role-plays are cycled through. The instructor does not interfere during the role-play unless learners veer off topic, require cues or assistance, or a safety issue arises. Following each role-play, the instructor debriefs the learner on their performance. Correct behaviours should be positively reinforced, and areas requiring improvement identified.

Advantages:

- High participation, interactive delivery.
- May lead to discussions.
- Experience is developed in a supportive environment.
- Can be very versatile depending on the topic.

Disadvantages:

- Participants can be easily sidetracked.
- Needs a lot of preparation and controls must be clarified.
- Competent, experienced and prepared instructors are needed.
- Not always successful due to group composition.

| Experiential Learning | |
|---|--|
| <p>Description: A method using knowledge and skills to meet objectives. There are four stages to this method: concrete experience, reflective observation, abstract conceptualization, and active experimentation.</p> | |
| <p>Applications: The method teaches:</p> <ul style="list-style-type: none"> • practical skills, • transferable skills, • problem solving, and • process or principle. | |
| <p>Preparation and Development: Step 1: Concrete Experience. Individuals have an experience and take time to identify and define it. Step 2: Reflective Observation. Provides time for individuals to reflect on visual, emotional, and cognitive aspects of the experience. Step 3: Abstract Conceptualization. Individuals work to understand and make connections between the experience and prior experiences. Step 4: Active Experimentation. Individuals look ahead to plan the application of skills and knowledge acquired for future experiences.</p> | |
| <p>Advantages:</p> <ul style="list-style-type: none"> • Knowledge is shared by the participants. • Most participants will create new knowledge. • Everyone is actively involved in the teaching and learning process. • Numerous resources are used. | <p>Disadvantages:</p> <ul style="list-style-type: none"> • Expensive as it uses many resources. • Requires a lot of planning, preparation and organization prior to the activity. • The instructor must master the subject developed. • May not be a good process for learning details. |

Case Study

Description:

A method using a written problem, situation or scenario to achieve a performance objective.

Applications:

- Used for learning principles, attitudes and concepts.
- Develops critical thinking and promotes teamwork.

Preparation and Development:

Give a problem that matches the experience level of the cadets.

Provide time to analyze it.

Responses to the problem should be recorded under four headings:

1. Facts,
2. Assumptions,
3. Problems, and
4. Solutions.

Advantages:







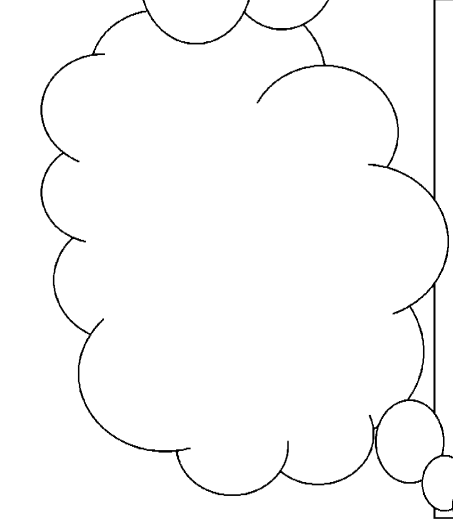
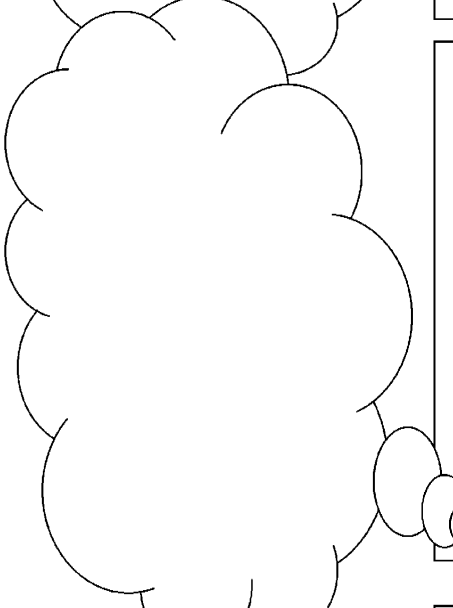
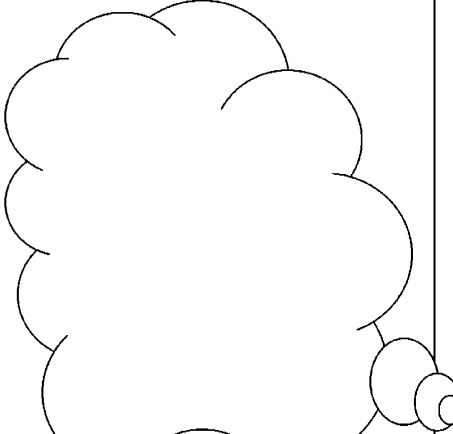

- Cadets can help each other learn.
- High energy.
- Relates to real-life applications.
- Can be used for past, present and future applications.

Disadvantages:

- Must be well organized and facilitated to ensure learning takes place.

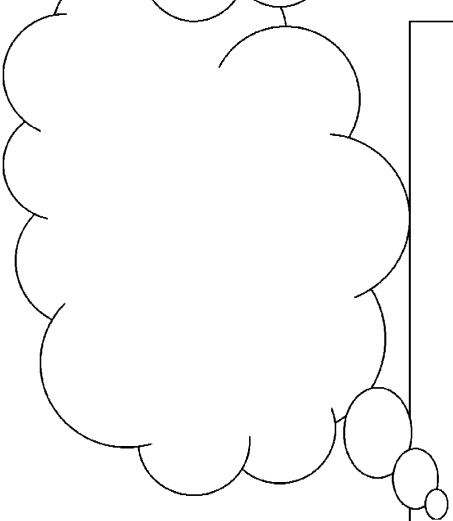
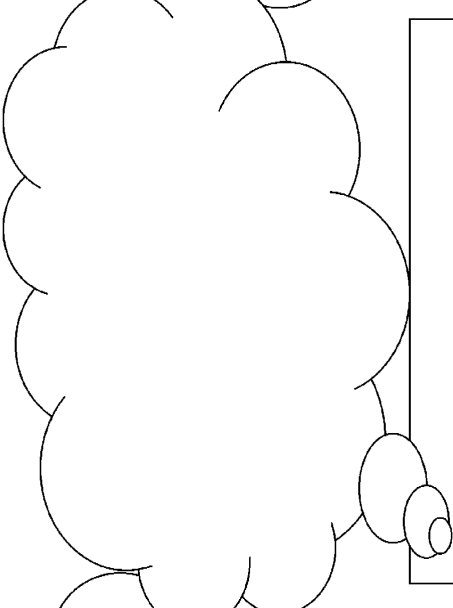
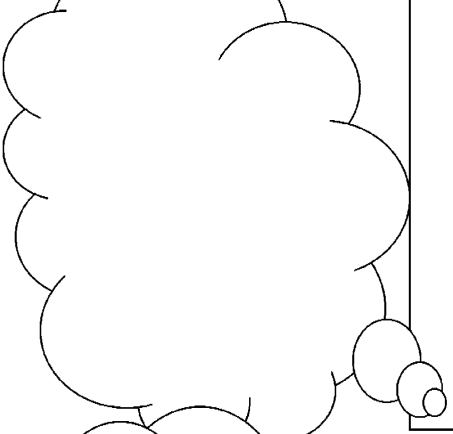
Methods

Write a method of instruction in each rectangle. Listen to each group present their method. In each cloud, list some characteristics defining the method.

| | | | | | |
|--|---|--|---|--|---|
|  |  |  |  |  |  |
|  |  |  |  |  |  |

THIS PAGE INTENTIONALLY LEFT BLANK

METHOD MADNESS

Topic: _____

Group Members: _____

Discuss the factors below in order to reach a decision on adopting a method of instruction.

| | |
|---|--|
| <p>Is the objective to:</p> <ul style="list-style-type: none"> • provide theory? • manual or procedural skills? • develop concepts? • instill desired attitudes? • develop teamwork? | <p>What is the type of content:</p> <ul style="list-style-type: none"> • Knowledge? • Theory? • How difficult is it? |
| <p>Know your cadets by determining the:</p> <ul style="list-style-type: none"> • existing skill, knowledge and attitude level of the students, • class size, • behaviour, • qualifications, • experience, and • skill level. | <p>Establish Materials / Equipment / Facilities:</p> <ul style="list-style-type: none"> • What? • Where? • Available? • Time? • Is it critical? |
| <p>Consider cost:</p> <ul style="list-style-type: none"> • Are funds available? • Is it cost effective? | <p>Know your ability as an instructor by determining:</p> <ul style="list-style-type: none"> • Existing skill, knowledge and attitude level? • Behaviour? • Availability? • Qualification? • Experience? • Skill level? |

THIS PAGE INTENTIONALLY LEFT BLANK

METHODS OF INSTRUCTION SUMMARY

Interactive Lecture. The instructor presents material such as events and facts and the cadets participate by responding to questions and engaging in discussion.

Examples:

Demonstration and performance. The instructor demonstrates a movement or skill, showing the cadet what to do, and explains, why, where and when it is applied. Then the cadets are given time to practice the movement or skill.

Examples:

In-class activity. A variety of activities that reinforce instructional topics.

Examples:

Practical activity: An interactive way to allow cadets to experience skill-based lessons.

Examples:

Game. Fun and challenging activity that allows for skill practice or knowledge confirmation.

Examples:

Field trip. Complements theoretical knowledge required by using concrete examples and allowing cadets to observe real-life applications of learning objectives.

Examples:

Group discussion. Cadets learn from peer responses, which provoke them to examine their own thoughts and experiences.

Examples:

Guided discussion. The instructor directs and stimulates the cadets' learning through a series of structured questions.

Examples:

Role-play. Cadets are assigned roles requiring them to interact with others in responding to various realistic situations.

Examples:

Experiential learning. Allows cadets to acquire new knowledge or skills through direct experience.

Examples:

Problem-based learning. Cadets analyze a problem and apply the steps in the problem-solving method.

Examples:

Case study. The primary purpose may not be to find a correct solution to the problem or issue posed, but to understand the principles involved in reaching a solution or analyzing an issue.

Examples:



**COMMON TRAINING
GOLD STAR
INSTRUCTIONAL GUIDE**



SECTION 2

EO M409.02 – IDENTIFY ELEMENTS OF A POSITIVE LEARNING ENVIRONMENT

Total Time:

60 min

PREPARATION

PRE-LESSON INSTRUCTIONS

Resources needed for the delivery of this lesson are listed in the lesson specification located in A-CR-CCP-704/PG-001, *Gold Star Qualification Standard and Plan*, Chapter 4. Specific uses for said resources are identified throughout the instructional guide within the TP for which they are required.

Review the lesson content and become familiar with the material prior to delivering the lesson.

Photocopy the Create a Positive Learning Environment Crossword Puzzle located at Attachment B for each cadet.

Ensure the different types of attention signals described in TP 3 are available for this EO.

PRE-LESSON ASSIGNMENT

Nil.

APPROACH

An interactive lecture was chosen for TPs 1 and 3 to provoke thought and stimulate the cadets' interest in the importance of a physically and emotionally safe learning environment and a well-managed classroom / training area.

A group discussion was chosen for TP 2 as it allows the cadets to interact with their peers and share their knowledge, experiences, opinions and feelings about stress management.

INTRODUCTION

REVIEW

Nil.

OBJECTIVES

By the end of this lesson the cadet shall have identified the importance of a physically and emotionally safe learning environment, discussed various techniques to manage stress and discussed classroom / training area management techniques.

IMPORTANCE

It is important for the cadets to identify elements of a positive learning environment because it will provide them with specific instructional strategies for motivating and engaging the cadets, for conducting interesting lessons and for boosting the cadets' self-confidence and self-esteem.

Teaching Point 1**Describe the importance of a physically and emotionally safe learning environment.**

Time: 15 min

Method: Interactive Lecture



The cadets should be able to relate to sitting in a classroom trying to listen to an instructor who may have been knowledgeable about the subject but who was unable to engage them. Brainstorm with the cadets the reasons why they may have been unable to concentrate on the lesson. Draw out aspects of the environment such as lighting, ventilation, physical space, the instructor's attitude toward the group and the cadets' relationship with their peers. Explain that these are aspects of the learning environment that directly affect their ability to learn.

THE IMPORTANCE OF A PHYSICALLY AND EMOTIONALLY SAFE LEARNING ENVIRONMENT

"Everything we know or sense about the world comes to us, in one way or another, through the environment in which we live." (Bell, 2007, <http://www.dialogueonlearning.tc3.edu/model/environment/Introduction-grp.htm>)

The learning environment includes the "physical environment" of the classroom or training area and the "emotional environment" that the cadets and instructor create in the classroom or training area. Aspects of the physical and emotional environment such as the lesson location, availability of resources, and cadets' level of stress and anxiety affect learning but are sometimes outside of the instructors' control. However, it is important that instructors try to minimize the effects of such hindrances to learning when they plan their lessons rather than simply know they exist and feel powerless to change them.

Physical Environment

The physical environment for cadet training will most likely change from training session to training session or even from lesson to lesson. Instructors fortunate enough to have a dedicated learning space will find it easier to create a stimulating physical environment, while others who are transient will find it more difficult. The first priority when considering the physical environment is safety. As a minimum standard the physical environment should have:

Adequate lighting. The connection between light and our emotions has long been recognized. Studies have also shown that learners perform better in brightly-lit learning environments than dimly-lit ones. It has also been shown that a learning environment with lots of natural light is more conducive to learning.

Good ventilation. It is important to be conscious of the temperature and air quality in a room because people are especially sensitive to these two elements. Cooler temperatures promote relaxation and receptivity while warmer temperatures promote acting out. If possible, open a window, turn on a fan or open a door to control temperature and air quality.

A colourful atmosphere. There is a connection between colour and moods and emotions. Warm colours (eg, red, orange, yellow) are exciting and may lead to acting out while cool colours (eg, blue, green, purple) are more relaxing. Researchers in brain-based learning suggest that the best colours for elements of the physical environment are yellow, light orange, beige or off-white. The cadets may react differently to the same colour depending on their emotional state. If cadets are feeling stressed, the colour red, for example, may bring out aggressive feelings but if they are relaxed, red can attract their attention.



The physical environment can be improved by adding colourful, visually appealing posters, pictures or other graphic images to the walls. If an instructor lacks control over these elements they should ensure that learning aids (handouts, electronic presentations, transparencies or flip charts) are colourful.

Flexible seating arrangements. The instructor should set up a learning environment that allows cadets to move quietly to take part in small and whole group learning activities. Having the cadets move from large to small group interactions will provide variety help them learn new material more efficiently.

Movement. Cadets learn better if there is movement during a period of instruction. The brain needs glucose, oxygen and water to function properly. Even if the air quality is good, the cadets may still be oxygen deprived because of improper breathing patterns caused by stress and anxiety. Lack of oxygen to the brain negatively impacts its ability to process information; increasing the flow of oxygen to the brain can improve its ability to process information. Physical activity is an excellent way to increase oxygen flow to the brain. Instructors can accomplish this by beginning their classes with 30–60 seconds of stretching or deep breathing and by taking breathing breaks during longer lessons or when they notice that the cadets' attention is lagging.

Water is also important for good brain functioning. Instructors should encourage the cadets to drink beverages, preferably water or fruit juices during lessons.



The brain consumes twenty percent of the body's energy.



Organize the cadets into pairs and have them alternate as they explain to one another how adequate lighting, good ventilation, colourful atmosphere, flexible seating arrangements and movement affect learning. Circulate around the room to get a sense of how well the cadets are processing the information. After all cadets have participated and all elements have been explained, continue with the lesson.

Emotional Environment



"Learning occurs best in an environment that contains positive interpersonal relationships and interactions, comfort and order, and in which the learner feels appreciated, acknowledged, respected and validated." (Earl, 2003, p. 39)

Instructors have a responsibility to make their classrooms as emotionally safe as possible so that learning can take place. If the brain senses a threat, it will ignore all other information to deal effectively with the threat. The perception of threat causes a "fight or flight" response which causes the body to transfer blood from the frontal cortex, or thinking part of the brain, to the bottom and back of the brain to prepare for survival. Any time cadets experience a sense of danger, whether physical or emotional, their bodies and brains react with this "fight or flight" response.

To maximize learning, instructors must create an emotional environment of relaxed alertness that allows the cadets to risk saying a wrong answer or solving a problem incorrectly. This is an emotionally safe learning environment.



Emotional safety is necessary for intellectual risk taking. (Earl, 2003, p. 103)

There are a number of strategies that can be used to achieve an emotionally safe learning environment. It is important for the instructor to:

Lead with a positive attitude. The cadets may have plenty of complications and negativity in their daily lives and will appreciate a positive environment with a positive and enthusiastic instructor. When instructors show interest in what they are teaching, the cadets will become interested as well.

Establish a friendly learning environment. The instructor should make it safe to learn by treating all cadets equally and respectfully and insisting that cadets treat one another in the same way. The instructor can build trust by keeping their word and by keeping information confidential if asked to do so. They should encourage the sharing of ideas, experiences and information and value the contribution of each learner. One simple thing that instructors can do is to be sensitive to the cadets' average attention span.



Use a maximum of one minute per year of age, as a guide, to get uninterrupted listening or active participation in an activity.

Make learning fun. The instructor should challenge the cadets with interesting activities that are not too easy or too difficult. They should try to challenge the cadets just beyond their present level of ability. If they are challenged too far beyond their level of ability, the cadets will give up but if they are challenged too little, they will become bored. Encourage the cadets to take risks and reward effort and energy as well as correctness. The instructor should listen empathetically by acknowledging nervousness, showing patience and being non-judgmental of the cadets' responses. In addition, the instructor should never single out cadets and always be attentive to those who seem isolated from the group. They should never use put-downs or sarcasm.



Instructors should keep the first challenge easy and the encouragement heavy and remember that they are students too but with the added responsibility of helping others learn.

Encourage supportiveness. The instructor should be supportive of the cadets and encourage them to be supportive of one another. Instructors can create a supportive environment by leading applause, thanking cadets for their input and rewarding effort.

Appeal to a variety of senses. The instructor should stimulate the cadets' senses in a variety of ways which will help them feel positive about the learning experience. As well, the instructor should be aware that the cadets will have different learning styles that should be catered to by using many different learning activities.

Provide feedback. The instructor's feedback should be specific and help the cadets compare their current progress to past performance rather than compare it to the performance of others. They should always be accurate and consistent and when they assign specific tasks to be done, they should tell the cadets that they will be coming back to check on their progress.



When providing feedback, the instructors should stress what is to be done rather than confuse the cadets by giving attention to what is not to be done.

Use encouragement. The instructor should use encouragement to boost the cadets' enthusiasm and self-esteem but must be careful not to confuse encouragement with reinforcement. Encouragement will make the cadets feel better but it will not improve their learning in the same way as providing specific feedback regarding a specific task. Instructors should be selective and provide encouragement when it is due to keep the cadets on track.



Instructors should encourage the cadets to look at incorrect responses or unsuccessful attempts at problem solving as research and not failure.

Communicate clear expectations and routines. A sense of safety comes from consistent and predictable behaviours on the part of the instructor. Instructors should not be too rigid but should develop consistent procedures for beginning lessons, getting the cadets' attention and handling disruptions and distractions. They should start every lesson by telling the cadets specifically what they will know or be able to do by the end of the lesson. They should conclude each lesson by reminding the cadets what they have learned or are able to do.

Provide processing time. Instructors should ensure that the cadets have enough time to process the information that they have just received. They should stop periodically during a lesson and allow the cadets to interact over new material which will help them store it in long-term memory for later recall. Instructors can use a variety of group or paired activities to enable the cadets to interact with one another. They can, for example, ask each cadet in a small group to successively respond to a question or comment on an idea. A variation of this type of interaction would be pairing cadets and having them respond alternately by listing one item of a series, by identifying a specific cause or effect of something or by providing a specific reason. The key is for the instructor to stop talking, ask a question, set a time limit and have the cadets interact in groups or pairs to process the information just presented.



Talking or lecturing beyond ten minutes is like pouring water into a glass that is already full.

Instructors must ensure, as much as possible, that the environment in which they instruct their lessons is learner friendly. The environment does affect learning and instructors must find ways to positively impact the learning environment for the cadets. The cadets should feel comfortable when giving answers, taking part in discussions and solving problems. Their incorrect responses to oral questions or attempts at solving a problem should not be put down or belittled but rather should be seen as the beginning of discovery.



Adult learners can overcome a poor learning environment because they are often self-motivated with a genuine interest in the subject or desire for personal gain. Cadets may not have a high degree of self-motivation so it is important to create a learning environment that will motivate them.

CONFIRMATION OF TEACHING POINT 1

Organize the cadets into pairs and have them alternately explain to one another two ways the instructor can establish a friendly learning environment, make learning fun and provide processing time.

Circulate around the room to get a sense of how well the cadets are processing the information. After all cadets have participated and the three items have been explained, continue with the lesson.

Teaching Point 2**Conduct a group discussion on stress management techniques.**

Time: 15 min

Method: Group Discussion

BACKGROUND KNOWLEDGE

The purpose of the group discussion is to draw the following information from the group using the tips for answering / facilitating discussion and the suggested questions provided.

STRESS

Stress is the body's reaction to a perception of a physical or emotional threat. The threat can be real or imagined; it is the perception of threat that triggers the stress response. During an acute stress response, the nervous system is activated automatically and the body experiences increased levels of cortisol, adrenalin and other hormones that produce an increased heart rate, quickened breathing rate and higher blood pressure. Blood is carried from the extremities to the big muscles preparing the body to fight or run away, which is commonly known as the "fight or flight" response. When the perceived threat is gone, our systems are designed to return to normal but this doesn't always happen because the threats can be frequent which causes constant anxiety.

Positive and negative stress are commonly labelled as eustress and distress respectively.

Eustress

Eustress is described as good stress and is created naturally when we participate in exciting but safe activities or when we trick the body into releasing small amounts of cortisol into the bloodstream. This type of stress pushes a person to do better and reach goals. Situations that might produce eustress include:

- riding a roller coaster;
- successfully completing an activity; or
- passing a test.



The prefix 'eu' in the word eustress is taken from the word euphoria which means a feeling of well being.

Distress

Distress is described as bad stress. This type of stress causes worry, anger or pain. Situations that might produce distress include:

- lack of sleep,
- accidents, or
- negative relationships with others.



Stress affects individuals differently. A situation that causes eustress for one person may cause distress for another.

TECHNIQUES FOR CREATING POSITIVE STRESS

Positive stress releases a small amount of cortisol into the bloodstream which can help the cadets learn more easily by improving their memory function. The instructor should use techniques, such as those described below, to create positive stress.

Design activities that challenge cadets. The instructor should design activities that challenge the cadets just beyond their present level of ability to encourage interest and prevent boredom.

Use movement. Instructors should incorporate movement into every lesson because it increases oxygen flow to the brain, which helps the cadets learn better. The movement should occur naturally during the lesson when the cadets are forced to stand up to give responses or move around to engage in a learning or confirmation activity. It does not have to be long but should be frequent during a lesson, which can have a cumulative effect on the brain.

Use music. Music, in addition to being enjoyable, has health benefits because it helps the body to produce cortisol. Instructors should have a good selection of music that they regularly use during their lessons as background noise or as an attention signal to begin a lesson or transition from one activity to another.

Breathe Properly. Breathing is how oxygen gets into the bloodstream to be delivered to the rest of the body. As automatic as it is, cadets may not be breathing well and should practice deep breathing activities to help increase oxygen flow.



Conduct a deep breathing activity by having the cadets:

1. lie on the floor on their back or sit in a comfortable position;
2. place one hand on their upper chest and one hand on their belly just above their waist;
3. breathe in slowly through their nose and feel the hand on their belly rise;
4. breathe out slowly through their mouth and feel the hand on their belly gradually lower; and
5. repeat steps three and four a few times.

If this activity is too disruptive or time consuming, simply encourage the cadets to take a few deep breaths periodically throughout a lesson to get more oxygen from the bloodstream to the brain, which will improve brain function.

TECHNIQUES FOR CONTROLLING NEGATIVE STRESS

If threats, or the perception of threats, are persistent, stress will become long term or chronic. The body can handle temporary or acute stress but not chronic stress and it may become ill. At the least, chronic stress impedes learning and must be prevented. In addition to using some of the techniques described above to create good stress, instructors should incorporate the following in their lessons to manage negative stress.



It is estimated that ninety percent of doctors' visits are for conditions in which stress, at least, plays a role.

Inform cadets of expectations. Instructors must clarify their expectations and communicate them to the cadets. Be specific, when assigning tasks, about what cadets will be expected to do, how they will be assessed and how they will receive extra training if necessary. Develop routines for beginning a lesson, transitioning from one activity to another during a lesson, getting the cadets' attention, dealing with different types of learners and ending a lesson. Routines may be repetitive and the cadets may complain at first, but routines that are realistically developed and consistently applied will allow the cadets to predict what will happen, which will ease their stress.

Provide necessary resources. The instructor must clearly and specifically inform the cadets what is expected of them and ensure that the cadets have all the material they need to complete the learning activity. The cadets will have limited time to complete the activity and will become frustrated if they have to collect material or improvise on their own. The instructor must ensure that all necessary equipment and supplies are readily available in the learning environment.

Provide adequate time to accomplish the task. When determining the amount of time for a task a good rule to follow is to assign one minute for each year of age. If an activity is long it should be broken down into manageable tasks.

Incorporate physical activity. The instructor should ensure that cadets move during every class either naturally as part of an activity or artificially when they notice the cadets' attention lagging.

Provide time to process information. Give the cadets enough time during a task to interact with their peers, in some way or another, over the content to help move it into long-term memory. This can be accomplished in a number of ways such as group interactions or some form of paired sharing. The important thing is to prevent time from becoming a hindrance to learning.

Practice relaxation techniques. There are a number of relaxation techniques to control negative stress. The benefit of such techniques is that they trick the body into thinking that the threat is gone and the increased blood circulation carries more oxygen to the brain, which allows the body to relax.

GROUP DISCUSSION



TIPS FOR ANSWERING / FACILITATING DISCUSSION:

- Establish ground rules for discussion, eg, everyone should listen respectfully; don't interrupt; only one person speaks at a time; no one's ideas should be made fun of; you can disagree with ideas but not with the person; try to understand others as much as you hope they understand you; etc.
- Sit the group in a circle, making sure all cadets can be seen by everyone else.
- Ask questions that will provoke thought; in other words avoid questions with yes or no answers.
- Manage time by ensuring the cadets stay on topic.
- Listen and respond in a way that indicates you have heard and understood the cadet. This can be done by paraphrasing their ideas.
- Give the cadets time to respond to your questions.
- Ensure every cadet has an opportunity to participate. One option is to go around the group and have each cadet answer the question with a short answer. Cadets must also have the option to pass if they wish.
- Additional questions should be prepared ahead of time.

SUGGESTED QUESTIONS:

- Q1. What is stress?
- Q2. How does breathing deeply help create positive stress?
- Q3. What are five things instructors can do to control negative stress?
- Q4. How can practicing relaxation techniques help control negative stress?
- Q5. How does music create positive stress?



Other questions and answers will develop throughout the group discussion. The group discussion should not be limited to only those suggested.



Reinforce those answers given and comments made during the group discussion, ensuring the teaching point has been covered.



If time allows, conduct an activity where the cadets will practice one of the relaxation exercises described in Attachment A.

CONFIRMATION OF TEACHING POINT 2

The cadets' participation in the group discussion will serve as the confirmation of this TP.

Teaching Point 3

Identify classroom / training area management techniques.

Time: 20 min

Method: Interactive Lecture

The classroom / training area for cadets may vary from session to session or even lesson to lesson depending on the type of training being conducted and the space available at the unit. Even if the instructor has the luxury of a dedicated space, it is important that they develop a classroom / training area management plan that will maximize the time available for a lesson. A management plan will prevent the instructor from wasting time getting the cadets' attention, transitioning from one activity to another, handling distractions and dealing with different types of learners.

A management plan should include the following but can be more detailed.

ATTENTION SIGNALS



Attention signals will work only if the cadets know what to do upon hearing or seeing the signal and the instructor has a positive expectation of success. If you do it, but do not actually expect the cadets to give you their attention, most likely they will not.

The instructor may find it useful to use an attention signal which immediately captures the cadets' attention when beginning a lesson, giving instructions, passing on information or transitioning from one activity to another. The attention signal should be both auditory and visual and the cadets should be taught to stop talking, stop working and establish eye contact immediately upon hearing and seeing the signal. Such an approach, when it becomes entrenched into the lesson's routine, will prevent the instructor from becoming frustrated and will help establish a calm tone for the lesson. The attention signal should be used consistently whenever there is a need to get the cadets' attention. The following attention signals may be used:

- **Raising a hand.** The instructor can simply raise their hand or raise their hand and say, "high five." Immediately upon hearing the phrase "high five" and seeing the instructor's hand go up the cadets should stop talking or moving, look at the instructor, raise their hand and repeat the phrase "high five" and keep their hand raised until the group is ready.
- **Flicking the light switch.** Immediately upon seeing the lights go on and off, the cadets should stop talking or moving and look at the instructor until the group is ready. An accompanying verbal command may include "high five" or some other phrase.
- **Sounding a bell, playing a musical tone or playing part of a song.** Immediately upon hearing the bell, musical tone or part of a song, the cadets should stop talking or moving and look at the instructor until the group is ready.
- **Clapping a rhythm.** The instructor claps a rhythm (dut, dut, dut, dut, dut). Immediately upon hearing the clapped rhythm the cadets should stop talking or moving, clap either a responding rhythm (dut, dut) or repeat the rhythm the instructor clapped and then look at the instructor until the group is ready.

- **Whistling.** Immediately upon hearing the whistle the cadets should to stop talking or moving and look at the instructor until the group is ready.



Use one of the attention signals and have the cadets respond with the appropriate behaviour or play the chorus from the song "Respect", have the cadets repeat "R-E-S-P-E-C-T" when they hear it and look at the instructor until the group is ready.



This is not an exhaustive list of attention signals. Some of the signals described above may be too childish for some groups. When deciding on a signal, consider the age, experience and maturity level of the group. Additional research of attention signals and experimenting with the group may help find one that works.

CORRECTING BEHAVIOUR

Instructors must be able to resolve disagreements, draw attention to the merits of differing opinions and maintain control of the classroom. They should prepare ahead of time and have a contingency plan for a range of behaviours similar to those listed below:

| LEARNER BEHAVIOUR | SOLUTIONS |
|--|--|
| <p>Quick Learner The cadet who consistently grasps concepts quickly and finishes work first could become disruptive if they begin to feel bored and unchallenged.</p> | <p>Provide this cadet with more advanced work. Ask this cadet to help others who require help. Have extra work prepared that reinforces the lesson.</p> |
| <p>Quiet Learner The cadet who rarely participates because they are shy, afraid, self-conscious or introverted.</p> | <p>Determine the cadet's interest and make it a topic for a group discussion. Discreetly encourage them to speak on the topic during the discussion asking questions that require short answers but occasionally ask more detailed questions.</p> |
| <p>Helpful Learner The cadet who is eager to help and agrees with everything the instructor says.</p> | <p>If the cadet is truly a generous person, explain in private that their behaviour is appreciated but could be misinterpreted by the group. If the cadet is trying to gain the favour of the instructor, advise the whole group that only merit will be rewarded.</p> |
| <p>Monopolizer The cadet who is always ready to express their views and can end up monopolizing the lesson.</p> | <p>Pose questions to this cadet that require only brief "yes" or "no" answers.</p> |
| <p>Critical Learner The cadet who consistently finds fault with the content or method of instruction.</p> | <p>Listen to the cadet's problems and satisfy them, if possible. If not possible, admit there are areas to be improved and ask for suggestions and solutions. Advise the cadet that you would be happy to discuss these issues after the lesson.</p> |

| LEARNER BEHAVIOUR | SOLUTIONS |
|--|--|
| <p>Know It All The cadet who considers themselves an authority on any topic being discussed and disrupts the class.</p> | <p>Determine if the cadet is knowledgeable or simply trying to get attention. Allow the cadet to answer some questions but allow other cadets to respond as well.</p> |
| <p>Distracter The cadet who attempts to get the group off topic. The cadet may do this to avoid revealing that they have not completed the assigned work or to avoid a difficult subject.</p> | <p>Recognize the types of questions that appear to relate to the lesson but will actually veer off topic. Acknowledge that the question does not relate to the topic but offer to discuss it after the lesson.</p> |



Organize the cadets into pairs and have them alternately describe to one another the different types of learners. Circulate around the room to get a sense of how well the cadets are processing the information. After all cadets have participated and the different types of learners have been described, continue with the lesson.

PROVIDING POSITIVE REINFORCEMENT

Deal with inappropriate academic performance and / or behaviour by emphasizing what is expected of the cadet rather than concentrating on what the cadet did wrong. The feedback should be:

- accurate,
- age-appropriate,
- specific, and
- consistent with the instructor's personal style.

It is extremely frustrating for cadets to be advised that their performance is unsatisfactory but to not know why. Instructors must:

- specifically and clearly identify what aspect of a performance is incorrect; and
- specifically and clearly identify what the cadet must do differently.

The cadets should also be asked to identify their own mistakes and explain why they made the error. In addition, the cadets should also be given the opportunity to:

- explain how to perform the task correctly; and
- practice the correct procedure.

ENGAGING THE CADET

Cadets are engaged when they are moving around or working in groups to manipulate information physically and mentally. Instructors can enhance learning by engaging in activities such as those described below.

Jigsaw worksheets. Instead of having cadets complete a worksheet individually, break them into small groups and assign a portion of the worksheet to each group. Each group must complete its assigned portion of the worksheet and use a poster or some other presentation aid to present the information to the whole group.

Graphics. Have the cadets create graphic organizers such as webs or mobiles to summarize information.

Creative writing. Have the cadets create rhymes, poems or songs to summarize information. If you are teaching terminology, symbols or similar information, have the cadets write a fairy tale or children's story using the information.

Create a chart. Type chronological information using a large font and cut it up into strips. Organize the cadets into pairs or small groups and give each pair or group an envelope with the strips of information and have them work together to place the information in the correct order and paste it on a sheet of chart paper or bristol board. Time the activity for fun.

Information chain. Have each cadet write one fact that they have learned during the class on a piece of coloured paper if possible. Have the class line up in front of the room and invite the first cadet to read their slip then fold it into a link and staple it. Invite the next student to read a fact and attach it to the chain and continue in this fashion until all cadets have created a link.

Scavenger hunt. Teach identification lessons such as parts of a rifle or parts of a compass by planting clues around the room and having cadets engage in a scavenger hunt. The clues may be actual items or pictures of items. When cadets find an actual item or some representation of it, they must describe the item to the group.

Road trip. Create a road trip. Place stop signs around the room containing information describing what the cadet must do. The cadets will travel to each place, complete the activity and have their passport stamped.



Organize the cadets into pairs and have them alternately explain to one another the different ways instructors can engage cadets. Circulate around the room to get a sense of how well the cadets are processing the information. After all cadets have participated and all activities have been explained, continue with the lesson.

MANAGING DISTRACTIONS

The best way for instructors to manage distractions is to prevent them from occurring by engaging the cadets in learning. Use attention signals to get the cadets' attention at the beginning of a lesson, while conducting an activity during a lesson and when transitioning from one activity to another. Instructors can prevent distractions by developing and consistently using routines that help cadets to predict the instructor's behaviour. Disruptions often occur when the cadets move from one activity to another during a lesson. Instructors should structure transitions by answering the following questions:

- Can the cadets talk during transitions?
- How can the cadets get the instructor's attention during a transition?
- What is the purpose of the transition?
- Can the cadets move during the transition?
- What is the desired behaviour during a transition?

Once a procedure has been established, the instructor should teach the cadets the structure through direct instruction and patient practice until the group responds appropriately. A possible approach to teaching transitions could include:

- calling the cadets to attention with the attention signal;
- numbering the cadets and assigning each number a specific task;
- informing the cadets of the rules regarding talking and moving around the room;

- informing the cadets of the procedure for getting the instructor's attention; and
- informing the cadets of the time permitted for the transition.



Instructors should encourage the cadets either individually or collectively when they may not expect it. Such encouragement may be particularly rewarding and will be considered genuine because it is attached to past behaviour and not necessarily designed to provoke further activity from the cadet.

CONFIRMATION OF TEACHING POINT 3

QUESTIONS:

- Q1. What is an attention signal?
- Q2. Identify one solution for dealing with cadets who get finished before others and become disruptive.
- Q3. Identify two questions instructors should answer to structure transitions.

ANTICIPATED ANSWERS:

- A1. An attention signal is a visual or auditory signal that immediately captures the cadets' attention when the instructor begins a class, gives instructions, passes on information or transitions from one activity to another.
- A2. Solutions include:
- providing the cadet with more advanced work;
 - asking the cadet to help others; or
 - having extra work prepared that reinforces the lesson.
- A3. Can the cadets talk during transitions?
 How can the cadets get the instructor's attention during a transition?
 What is the purpose of the transition?
 Can the cadets move during the transition?
 What is the desired behaviour during a transition?

END OF LESSON CONFIRMATION

Have the cadets complete the Create a Positive Learning Environment Crossword Puzzle located at Attachment B.

Review answers using the Create a Positive Learning Environment Crossword Puzzle Answer Key located at Attachment C.

CONCLUSION

HOMEWORK / READING / PRACTICE

Nil.

METHOD OF EVALUATION

This EO is assessed IAW A-CR-CCP-704/PG-001, *Gold Star Qualification Standard and Plan*, Chapter 3, Annex B, 409 PC.

CLOSING STATEMENT

Creating a positive learning environment requires planning and work by instructors. A safe, respectful and positive learning environment is more than a boost to self-confidence and self-esteem or a way to make learning fun—it is the cadet's right and an excellent way to make them want to learn.

INSTRUCTOR NOTES / REMARKS

Nil.

REFERENCES

A0-055 A-P9-050-000/PT-006 Director Training and Education Policy. (2002). *Canadian Forces individual training and education system* (Vol. 6). Ottawa, ON: Department of National Defence.

A0-118 Director Cadets 3. (2007). *Youth reference guide*. Ottawa, ON: Department of National Defence.

C0-191 ISBN 978-0-7360-6675-4 Corbin, C. & Lindsey, R. (2007). *Fitness for life: Updated fifth edition*. Windsor: Human Kinetics.

C0-375 ISBN 978-1-879097-10-0 Kagan, S., & Kagan, M. (2009). *Kagan cooperative learning*. San Clemente, CA: Kagan Publishing.

C0-376 ISBN 0-7619-4626-8 Earl, L. M. (2003). *Assessment as learning*. Thousand Oaks, CA: Corwin Press, Inc.

C0-380 Scott, E. (2008). *Cortisol and stress: How to stay healthy*. Retrieved February 25, 2009, from <http://www.Stress.about.com/od/stresshealth/a/cortisol.htm?p=1>

C0-381 McDonald, E. (2006). *How to involve and engage students*. Retrieved March 4, 2009, from http://www.education-world.com/a_curr/columnists/mcdonald/mcdonald007.shtml

C0-382 Bear, T. C. (2009). *Quiet signals for getting attention and control of your classroom*. Retrieved February 27, 2009, from <http://www.teachercreated.com/blog/?tag=attention-signals>

C0-383 Bell, A. (2007). *Creating a learning centered environment—Introduction*. Retrieved February 23, 2009, from <http://www.dialogueonlearning.tc3.edu/model/environment/Introduction-grp.htm>

C0-384 Handy, K. (2009). *Classroom management plan*. Retrieved February 27, 2009, from <http://www.katiehandy.wordpress.com/classroom-management-plan/>

C0-385 Boudreau, D. (2008). *Creating the ideal learning environment—Emotional*. Retrieved February 25, 2009, from <http://ezinearticles.com/?Creating-the-Ideal-Learning-Environment---Emotional&id=1536435>

RELAXATION EXERCISES

Rag Doll

1. Sit in a chair (or stand) with feet apart.
2. Stretch the arms and trunk upward and inhale.
3. Exhale and drop the body forward. Let the trunk, head and arms dangle between the legs, keeping the muscles relaxed (as illustrated in Figure 1).
4. Remain in this position for 10–15 seconds.
5. Slowly roll up, one vertebrae at a time.

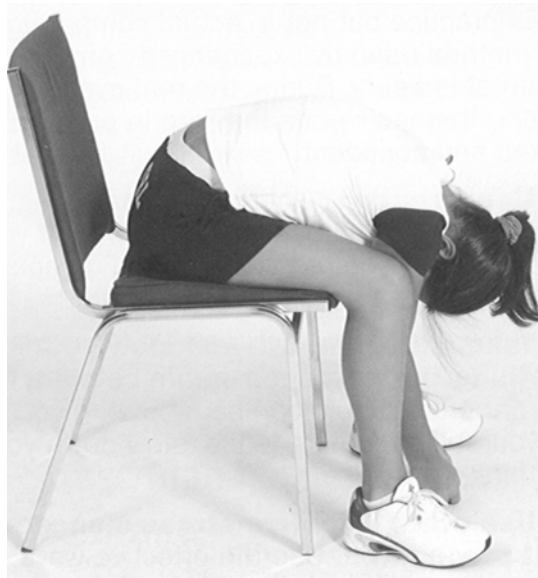

Figure A-1 Rag Doll

Note. From *Fitness for Life: Updated Fifth Edition* (p. 300), by C. Corbin, & R. Lindsey, 2007, Windsor, ON: Human Kinetics. Copyright 2007 by The Cooper Institute.

Neck Roll

1. Sit in a chair or on the floor with legs crossed.
2. Keeping the head and chin tucked, inhale and slowly turn the head as far left as possible (as illustrated in Figure 2).
3. Exhale and turn the head to the centre.
4. Repeat steps 2–3 for the right side.
5. Repeat steps 2–4 three times, trying to turn further each time to feel the stretch in the neck.
6. Drop the chin to the chest and inhale while slowly rolling the head in a semicircle to the left shoulder and exhale while slowly rolling the head back to the centre.
7. Repeat step 6 for the right side.



Do not roll the head backward or in a full circle.



Figure A-2 Neck Roll

Note. From *Fitness for Life: Updated Fifth Edition* (p. 300), by C. Corbin, & R. Lindsey, 2007, Windsor, ON: Human Kinetics. Copyright 2007 by The Cooper Institute.

Body Board

1. Lie on the right side with arms over the head (as illustrated in Figure 3).
2. Inhale and stiffen the body like a wooden board.
3. Exhale and relax the muscles and collapse.
4. Let the body fall without trying to control the direction (as illustrated in Figure 4).
5. Lie still for ten seconds.
6. Repeat steps 1–5 for the left side.



Figure A-3 Body Board Start Position

Note. From *Fitness for Life: Updated Fifth Edition* (p. 301), by C. Corbin, & R. Lindsey, 2007, Windsor, ON: Human Kinetics. Copyright 2007 by The Cooper Institute.

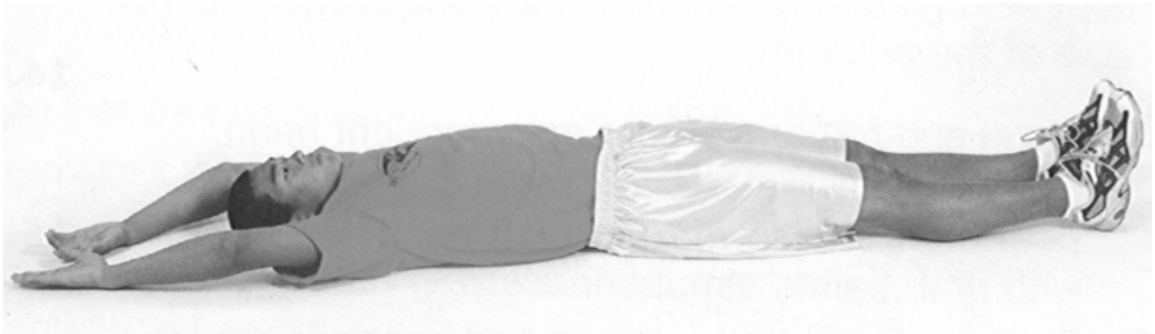

Figure A-4 Body Board Finish Position

Note. From *Fitness for Life: Updated Fifth Edition* (p. 301), by C. Corbin, & R. Lindsey, 2007, Windsor, ON: Human Kinetics. Copyright 2007 by The Cooper Institute.

Jaw Stretch

1. Sit in a chair or on the floor with head up and arms and shoulders relaxed.
2. Open mouth as wide as possible and inhale.
3. Relax and exhale slowly.
4. Shift the jaw to the right as far as possible and hold for three seconds (as illustrated in Figure 5).
5. Repeat step 4 for the left side.
6. Repeat steps 4–5 ten times.

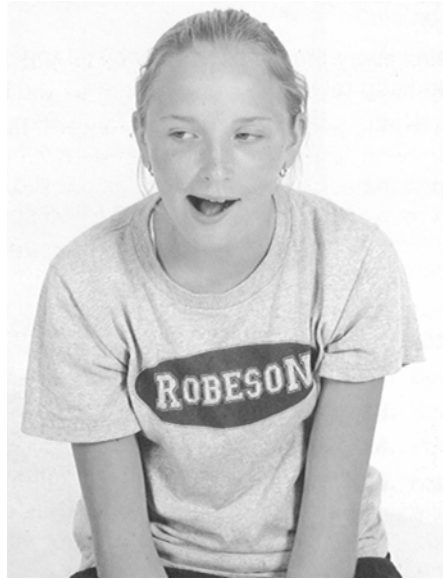
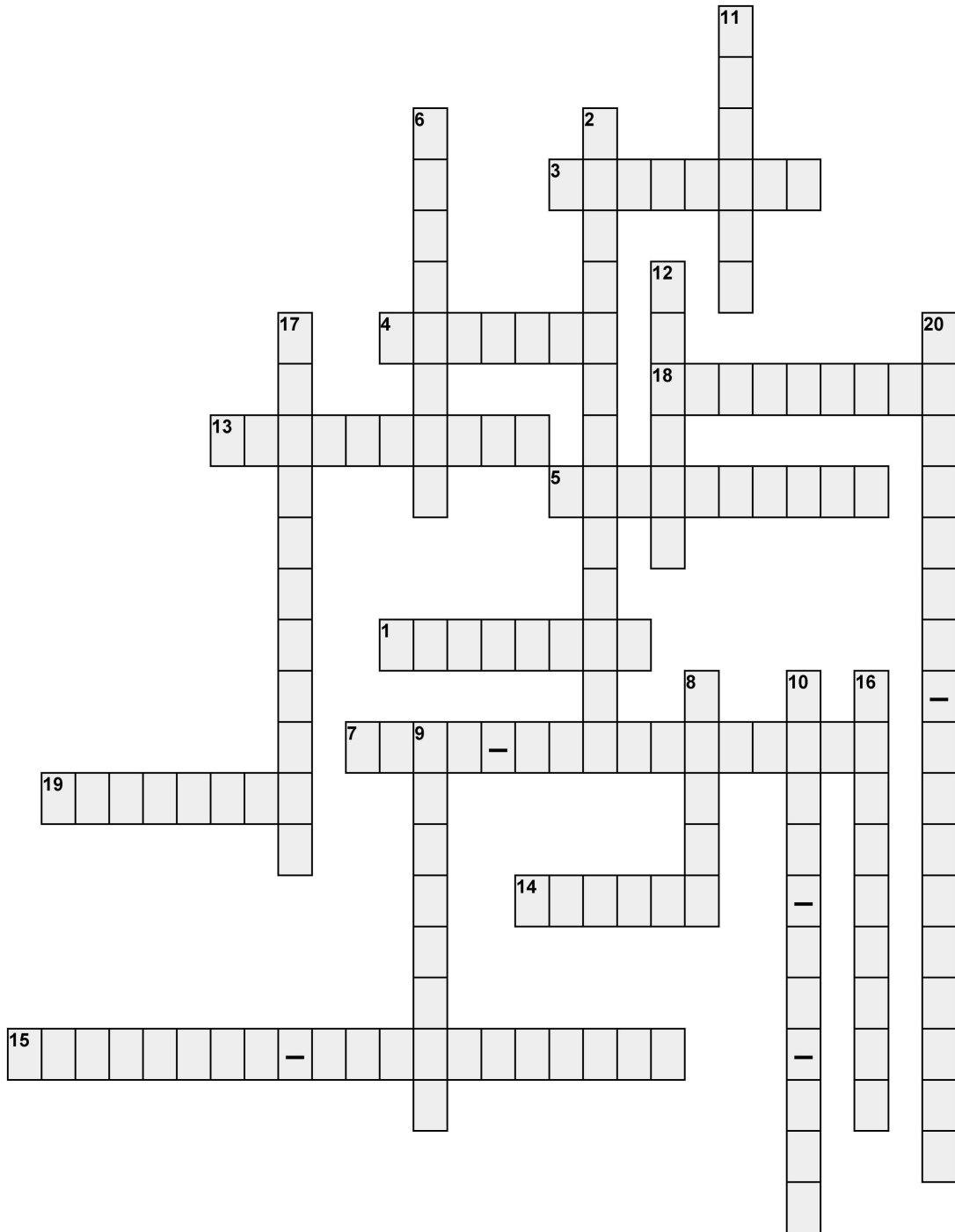

Figure A-5 Jaw Stretch

Note. From *Fitness for Life: Updated Fifth Edition* (p. 301), by C. Corbin, & R. Lindsey, 2007, Windsor, ON: Human Kinetics. Copyright 2007 by The Cooper Institute.

CREATE A POSITIVE LEARNING ENVIRONMENT CROSSWORD PUZZLE



Word List

physical environment, relaxation, movement, brain, stress, relaxed alertness, memorable, past performance, predict, processing, eustress, distress, cortisol, visual, know it all, specific, self-esteem, quiet learner, emotionally, oxygen

Clues

Across:

1. Furniture should be arranged to allow for _____.
3. Positive stress is called _____.
4. Using consistent routines will help cadets _____ instructor behaviour.
5. Cooler temperatures lead to this _____.
7. Feedback should help cadets compare current progress with _____.
13. Moving information from working memory to long term memory is called _____ information.
14. Deep breathing helps get _____ into the blood stream.
15. The place where a lesson takes place is _____.
18. Reinforcement boosts learning but encouragement boosts _____.
19. Music and movement help the body to produce _____.

Down:

2. The cadet who rarely participates is called a _____.
6. Negative stress is called _____.
8. 20% of the body's energy is consumed by the _____.
9. Feedback should be accurate, age-appropriate, consistent and _____.
10. Cadets who think they are authorities on any topic are called _____.
11. Fight or flight is the body's response to _____.
12. Attention signals should be both auditory and _____.
16. When our senses are stimulated the learning experience will become more _____.
17. When cadets feel comfortable and relaxed the environment is said to be _____ safe.
20. To maximize learning the emotional environment should create _____.

CREATE A POSITIVE LEARNING ENVIRONMENT ANSWER KEY

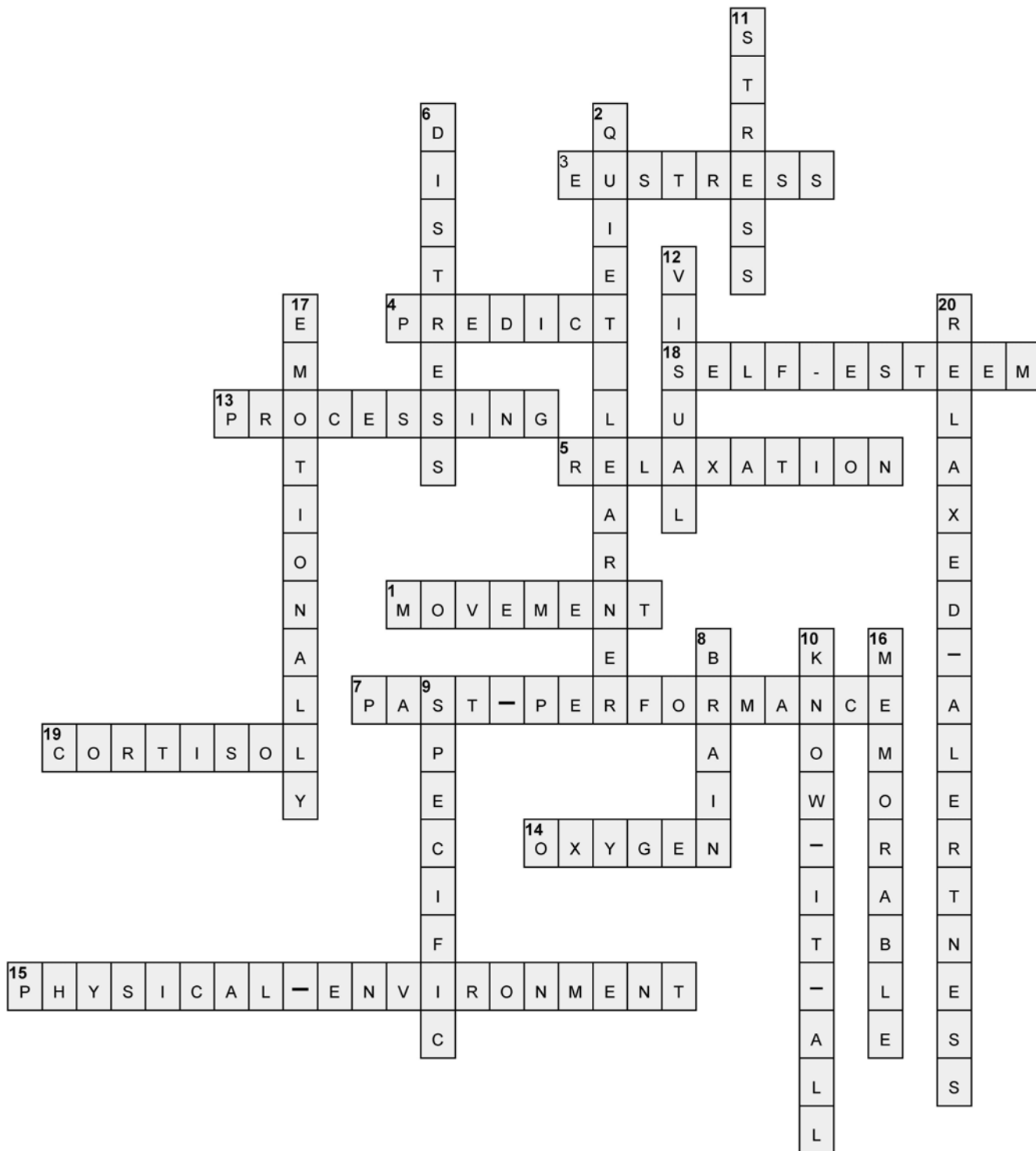

CREATE A POSITIVE LEARNING ENVIRONMENT ANSWER KEY (CONT'D)

Clues

Across:

1. Furniture should be arranged to allow for _____. (MOVEMENT)
3. Positive stress is called _____. (EUSTRESS)
4. Using consistent routines will help cadets _____ instructor behaviour. (PREDICT)
5. Cooler temperatures lead to this _____. (RELAXATION)
7. Feedback should help cadets compare current progress with _____. (PAST PERFORMANCE)
13. Moving information from working memory to long term memory is called _____. (INFORMATION PROCESSING)
14. Deep breathing helps get _____ into the blood stream. (OXYGEN)
15. The place where a lesson takes place is _____. (PHYSICAL ENVIRONMENT)
18. Reinforcement boosts learning but encouragement boosts _____. (SELF-ESTEEM)
19. Music and movement help the body to produce _____. (CORTISOL)

Down:

2. The cadet who rarely participates is called a _____. (QUIET LEARNER)
6. Negative stress is called _____. (DISTRESS)
8. 20% of the body's energy is consumed by the _____. (BRAIN)
9. Feedback should be accurate, age-appropriate, consistent and _____. (SPECIFIC)
10. Cadets who think they are authorities on any topic are called _____. (KNOW IT ALL)
11. Fight or flight is the body's response to _____. (STRESS)
12. Attention signals should be both auditory and _____. (VISUAL)
16. When our senses are stimulated the learning experience will become more _____. (MEMORABLE)
17. When cadets feel comfortable and relaxed the environment is said to be _____ safe. (EMOTIONALLY)
20. To maximize learning the emotional environment should create _____. (RELAXED ALERTNESS)



**COMMON TRAINING
GOLD STAR
INSTRUCTIONAL GUIDE**



SECTION 3

EO M409.03 – DESCRIBE LEARNER NEEDS

Total Time:

60 min

PREPARATION

PRE-LESSON INSTRUCTIONS

Resources needed for the delivery of this lesson are listed in the lesson specification located in A-CR-CCP-704/PG-001, *Gold Star Qualification Standard and Plan*, Chapter 4. Specific uses for said resources are identified throughout the instructional guide within the TP for which they are required.

Review the lesson content and become familiar with the material prior to delivering the lesson.

Create slides of Attachments A and H.

Photocopy and three-hole punch Attachments B, D, E, F, I and K for each cadet.

Photocopy Attachment C and cut into strips.

Make two copies of Attachments J and L.

Ensure that the cadets bring the binder provided in EO M409.01 (Identify Methods of Instruction).

PRE-LESSON ASSIGNMENT

Nil.

APPROACH

An interactive lecture was chosen for TPs 1 and 2 to introduce, provoke thought and stimulate the cadet's interest in learner needs.

An in-class activity was chosen for TPs 3 and 4 as it is an interactive way to provoke thought and stimulate interest in the different types of learners and how to meet their needs.

INTRODUCTION

REVIEW

Nil.

OBJECTIVES

By the end of this lesson the cadets shall have described how developmental periods and learning styles determine learner needs.

IMPORTANCE

Instructors must develop an appreciation for all learning styles in order to meet learner needs. Being aware of developmental periods will provide instructors with the necessary tools to plan relevant and meaningful lessons.

Teaching Point 1**Describe the importance of making material relevant and meaningful, and providing information processing time.**

Time: 5 min

Method: Interactive Lecture



Display the slide of Tiger Comic located at Attachment A to focus the cadets' thoughts toward the learning process.

Learning is a complex process. There are many theories about how learning occurs. Determining what is relevant is the first step to ensure that the learning is meaningful. Understanding the age appropriate learning categories provides some insight into how the brain is working to process information.

RELEVANT LEARNING

Relevant. Determining why and if the material is necessary to know. Once this is determined the learner decides whether or not they engage in committing the information to memory.



Albert Einstein said, "Everything should be made as simple as possible, but not simpler."

In other words, teach to the level of the cadets. The level of difficulty determines whether or not the cadets engage in the lesson. Essentially, less is more when it comes to new material.

MEANINGFUL LEARNING

Providing meaningful and relevant material results in greater overall retention.

Learning becomes meaningful when cadets understand material and store it in the brain. A learning experience is meaningful when the learners engage in three processes:

1. reflecting upon prior knowledge;
2. relating to real-life experiences; and
3. applying knowledge in future experiences.

Retention is the ability to remember material after the material is presented. The more information is repeated, the better the retention.



Display the following on flip chart paper / white board.

Learners retain:

- 10% of what they read,
- 26% of what they hear,
- 30% of what they see,
- 50% of what they see and hear,
- 70% of what they say, and
- 90% of what they say and do.

Information is stored in different places in the brain depending on the type of information. Emotions have a great influence on learning. The stronger the emotions connected with an experience, the stronger the memory.

Various types of information are associated with a specific type of memory (as illustrated in Figure 1).

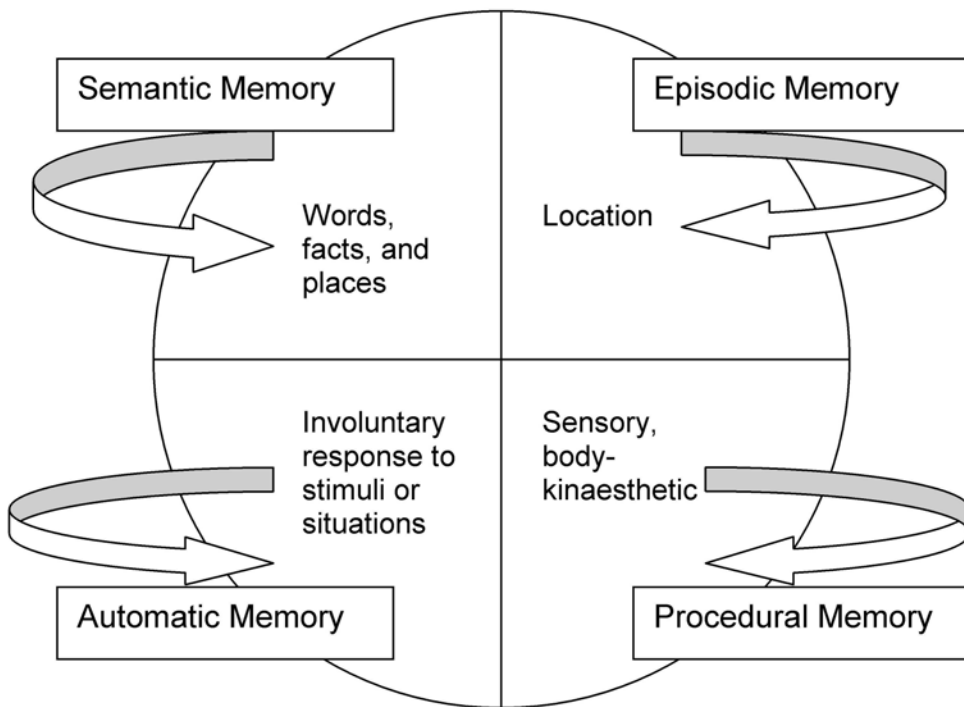

Figure 1 Types of Memory

Note: Created by Director Cadets 3, 2009, Ottawa, ON: Department of National Defence.

PROCESSING TIME

Attention span. The average attention span is about one minute per year of age to a maximum of 15 years.

Allowing time for cadets to apply their learning is important so they can move information from their working memory to their long-term memory. The processing time is known as "thinking about thinking", where cadets can reflect on the lesson and plan, monitor, and evaluate their own thinking and learning.



Distribute the Learning Pyramid located at Attachment B to show the relationship between learning and remembering.

CONFIRMATION OF TEACHING POINT 1

QUESTIONS:

- Q1. What does relevant mean?
- Q2. What three processes involve the learner to have a meaningful learning experience?
- Q3. What is retention? How is it increased?

ANTICIPATED ANSWERS:

- A1. Determining why and if the material is necessary to know. Once this is determined the learner will decide whether or not they will engage in actually committing the information to memory.
- A2. The learner actively:
 - a. reflects upon prior knowledge;
 - b. relates to real-life experiences; and
 - c. applies knowledge in future experiences.
- A3. Retention is the ability to remember material after it is presented. The more information is repeated, the better the retention.

Teaching Point 2

Describe and identify the needs of the developmental periods (DP).

Time: 10 min

Method: Interactive Lecture

DESCRIBE DEVELOPMENTAL PERIODS (DP)

The mental, physical, emotional and social development of a cadet are considered when determining a DP. They are age-based and they focus on refining higher-level thinking skills such as reasoning, reflective thinking, and problem solving. The three are also known as age-appropriate learning categories (as illustrated in Figure 2).

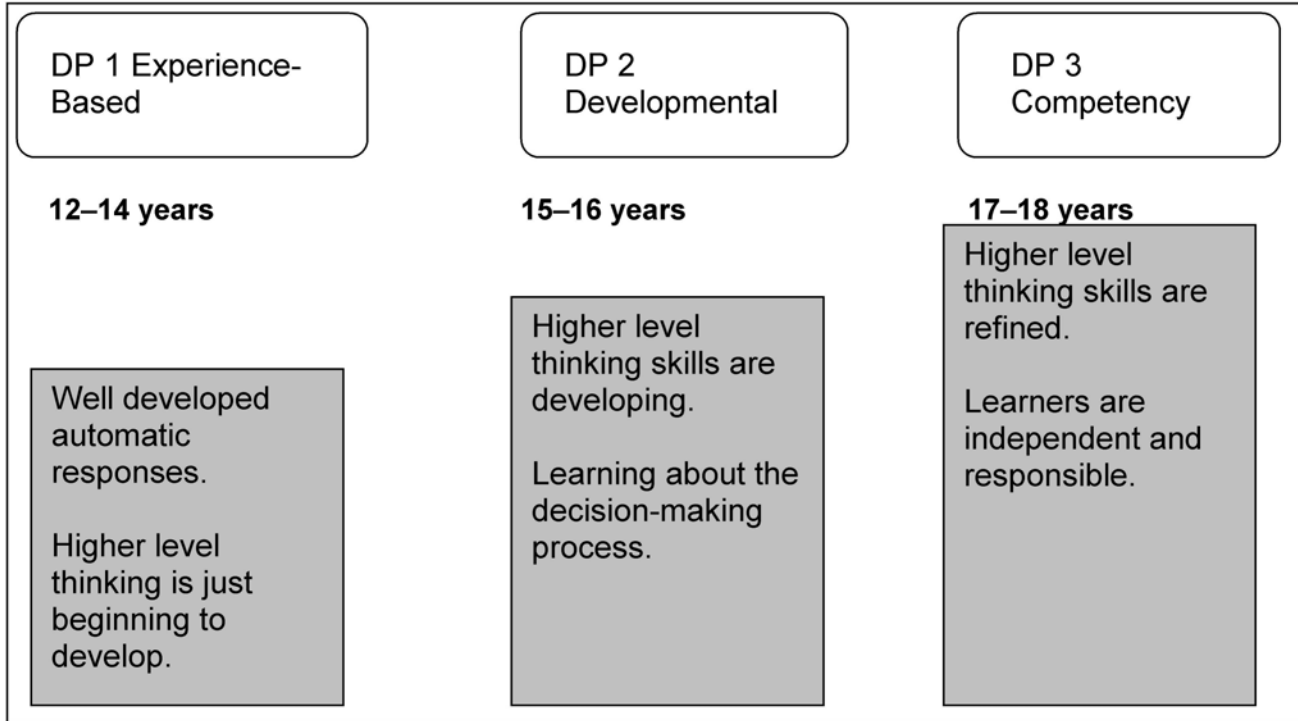



Figure 2 Identifying DPs

Note: Created by Director Cadets 3, 2009, Ottawa, ON: Department of National Defence.

An instructor must plan their lessons based on the DP of the cadets. When planning a lesson it is important to consider what type of activities and questions to ask. For example, each DP indicates how long an activity should last:

- **DP 1.** Activities in a lesson should end in that same lesson.
- **DP 2.** Activities started in a lesson may extend over two to three lessons.
- **DP 3.** Activities started in a lesson may extend over four or more lessons.

NEEDS OF DPs



The following information focuses on DPs 1 and 2 only since the cadets will not be planning lessons for cadets in DP 3.

Experienced-based DP 1 (12–14 years):

- understand what is concrete / real not abstract;
- have mastered reflexive responses;
- require close supervision;
- want interaction and activity in lessons; and
- are very "me" oriented.

Developmental DP 2 (15–16 years):

- in a transition period—moving from understanding the concrete to understanding the abstract;
- beginning to use higher level thinking skills and are comfortable with the concrete;
- want to practice and explore new thinking skills;
- begin to understand cause and effect relationships;
- concerned with fairness—value system kicks in—need for equality for all; and
- asking questions like "how do I fit in?" and "how does this affect me?"

Four areas to consider when teaching within these DPs are:

- active and interactive lessons,
- structured activities,
- the opportunity for choice within the lesson, and
- goals definition.

Each area varies from low to high depending on the age and DP. However, active and interactive lessons are emphasized in all three DPs.

Lessons are planned by incorporating criteria based on the DPs (as illustrated in Figure 3).

| Criteria for Activities | Experience-Based | Developmental | Competency |
|-------------------------|--------------------|---------------|--------------------------------------|
| Active and Interactive | yes | yes | yes |
| Structured | very | some | cadet-run and supervised by officers |
| Provide Choice | minimal | some | much |
| Goals | clear and concrete | clear | abstract |

Figure 3 Needs for Developmental Periods

Note: Created by Director Cadets 3, 2009, Ottawa, ON: Department of National Defence.

ACTIVITY

Time: 5 min

OBJECTIVE

The objective of this activity is to have the cadets describe and identify the DPs.

RESOURCES

Developmental Periods Confirmation strips located at Attachment C.

ACTIVITY LAYOUT

Nil.

ACTIVITY INSTRUCTIONS

1. Distribute the strips of paper from Attachment C to the cadets.



There are only 10 strips. If there are more than 10 cadets they may work in pairs / groups. If there are less than 10 cadets, some cadets may have more than one strip.

2. Ask the cadets who have a DP to come forward and tape their strip on the board.
3. Ask each cadet to read each strip to the class and decide what DP it describes. If the cadet is having difficulty, other cadets may help.
4. Once a decision has been made, tape the strip under the respective category.

CONFIRMATION OF TEACHING POINT 2

The cadets' participation in the activity will serve as the confirmation of this TP.

Teaching Point 3

Conduct an activity where the cadets will describe and identify the needs of the different learning styles.

Time: 20 min

Method: In-Class Activity

ACTIVITY

OBJECTIVE

The objective of this activity is to have the cadets describe and identify the needs of learners.

RESOURCES

- Learning Styles Information Sheet located at Attachment D,
- Learning Styles Survey located at Attachment E,
- How to Make a Jumping Frog located at Attachment F,
- How to Make a Triangular Box located at Attachment G,
- Slide of *Schoolies* comic located at Attachment H,
- Letter size paper for each cadet,
- Square sized sticky notes (eg, size 3 inches by 3 inches), and
- Sticky notes—4 inches by 6 inches.



In this lesson, sticky notes are used instead of origami paper (which is optimal). However, if sticky notes are not available, cut any paper according to the sizes recommended above.

ACTIVITY LAYOUT

Nil.

ACTIVITY INSTRUCTIONS

1. Distribute the Learning Styles Information Sheet located at Attachment D. Read through the handout together.
2. Distribute the Learning Style Survey located at Attachment E. Have the cadets read each question and choose the most appropriate answer. Once they have answered all questions, have the cadets total each letter to determine their individual learning style.
3. Designate three areas of the classroom to represent each learning style: visual, kinaesthetic, and auditory. Have the cadets move to the group that reflects their learning style as indicated in the survey.



The groups should be uneven. Compare class results with the distribution of learning style percentage as indicated in the Learning Styles Information Sheet located at Attachment D.

4. Have the cadets return to their seats.
5. Distribute a piece of letter size paper, three square sticky notes, and one 4 inch by 6 inch sticky note to each cadet.



The activities are intended to allow the cadets to experience difficulty while using each one of the learning styles. Emphasis is on the cadets experiencing each learning style and not the completion of each activity. It is not important for the cadets to complete each activity, since they are for initial experiences only. Allot 2–3 minutes for each activity.

6. Have the cadets experience the auditory learning style by:
 - a. listening to the directions to make a paper object;
 - b. performing the direction as it is said; and
 - c. refraining from asking questions as the directions are being given.



For this activity, have the cadets use the letter size paper. Read the following directions aloud to the cadets on how to make a paper boat:

1. Fold a piece of paper in half, from top to bottom.
2. Fold the right corner into the middle of the paper.
3. Fold the left corner into the middle of the paper.
4. Fold the bottom of the paper up against both sides.
5. Insert thumbs into the bottom to make a square.
6. Fold the bottom corners over each other to create a triangle.
7. Insert thumbs into the bottom to make a square.
8. Hold the paper with flaps down.
9. Fold the corners to the top point.
10. Pull the middle out to form a square.
11. Pull the two triangles at the top apart to create a boat.



For the next activity, have the cadets use the 4 inch by 6 inch sticky notes. Distribute How to Make a Jumping Frog located at Attachment F to each cadet.

7. Have the cadets experience the visual learning style by:
 - a. seeing pictures to make a jumping frog;
 - b. reading the directions to make a jumping frog; and
 - c. performing the task without assistance.



For the next activity, have the cadets use the square sticky note. Use How to Make a Triangular Box located at Attachment G and demonstrate each step so the cadets can see.

8. Have the cadets experience the kinaesthetic learning style by:
 - a. watching the instructor make a triangle box without verbal or written directions, and
 - b. performing the task without assistance.
9. Discuss the cadets' feelings towards each of the learning styles by provoking these thoughts:
 - a. What learning style was dominant in each of the activities?
 - b. What task was most difficult?
 - c. What task was the easiest?



Display the slide of *Schoolies* comic located at Attachment H.

CONFIRMATION OF TEACHING POINT 3

The cadets' participation in the activity will serve as the confirmation of this TP.

Teaching Point 4

Conduct an activity where the cadets will identify how to structure a lesson to meet the needs of the different types of learners.

Time: 15 min

Method: In-Class Activity

ACTIVITY**OBJECTIVE**

The objective of this activity is to have the cadets identify how to structure a lesson to meet the needs of types of learners.

RESOURCES

- Instructor Tips for Learning Styles worksheet located at Attachment I,
- Instructor Tips for Learning Styles Answer Key located at Attachment J,
- Activities in Developmental Periods worksheet located at Attachment K,
- Activities in Developmental Periods Answer Key located at Attachment L,
- Flip chart paper,
- Stopwatch,
- Markers, and
- Pens / pencils.

ACTIVITY LAYOUT

Set up workstations by taping flip chart paper around the classroom.



The number of workstations can be determined by dividing the class number by two or four. For example, if the class size is small divide by two, and if it is large divide by four.

ACTIVITY INSTRUCTIONS

1. Divide the cadets into two groups by assigning each cadet a number: Number 1 or Number 2. Arrange the cadets so that each group is sitting on opposite sides of the classroom.
2. Distribute the Instructor Teaching Tips for Learning Styles worksheet located at Attachment I to the cadets in Group 1 and the Activities in Developmental Periods worksheet located at Attachment K to Group 2.
3. Have the cadets work in their groups to fill out their worksheets.



Allocate two minutes for the cadets to work on the worksheets. It is not important to fully complete the sheets.

4. Distribute the answer keys located at Attachments J and L to one cadet in each group.
5. Have the cadet with the answer key in the each group read out the correct answers while the other cadets mark their worksheets and fill in any missing answers.
6. Have the cadets pair up with a cadet from the other side of the classroom and move to one of the workstations.



When the class size is large, two pairs can be assigned to each work station.

7. Give the cadets 2–3 minutes to explain on the chart paper how a DP 1 lesson would be structured differently than a DP 2 lesson. The cadets may use ideas from the worksheets and handouts in the class.
8. Have each group discuss their ideas for 2–3 minutes.



Distribute the remaining copies of Attachments I and K to those cadets that did not receive them earlier in the activity.

SAFETY

Nil.

CONFIRMATION OF TEACHING POINT 4

The cadets' participation in the activity will serve as the confirmation of this TP.

END OF LESSON CONFIRMATION

The cadets' participation in the in-class activities will serve as the confirmation of this lesson.

CONCLUSION

HOMEWORK / READING / PRACTICE

Nil.

METHOD OF EVALUATION

This EO is assessed IAW A-CR-CCP-704/PG-001, *Gold Star Qualification Standard Plan*, Chapter 3, Annex B, 409 PC.

CLOSING STATEMENT

Understanding what makes information relevant and meaningful is important when it comes to instructing. Defining learning styles and identifying developmental stages helps identify instructional strategies that will meet the learners' needs and ultimately provide them with a healthy and welcoming learning environment.

INSTRUCTOR NOTES / REMARKS

Nil.

REFERENCES

A0-118 Director Cadets 3. (2007). *Youth reference guide*. Ottawa, ON: Department of National Defence.

C0-397 Belding, S. (2004). *Stickiness: Skills retention and synthesis*. Retrieved March 23, 2009, from http://www.airs.org/files/public/Making_Training_Stick.pdf

C0-398 ISBN I-57517-344-1 Burke, K. (2000). *What to do with the kid who....* Arlington Heights, IL: Skylight Professional Development.

THIS PAGE INTENTIONALLY LEFT BLANK

TIGER COMIC

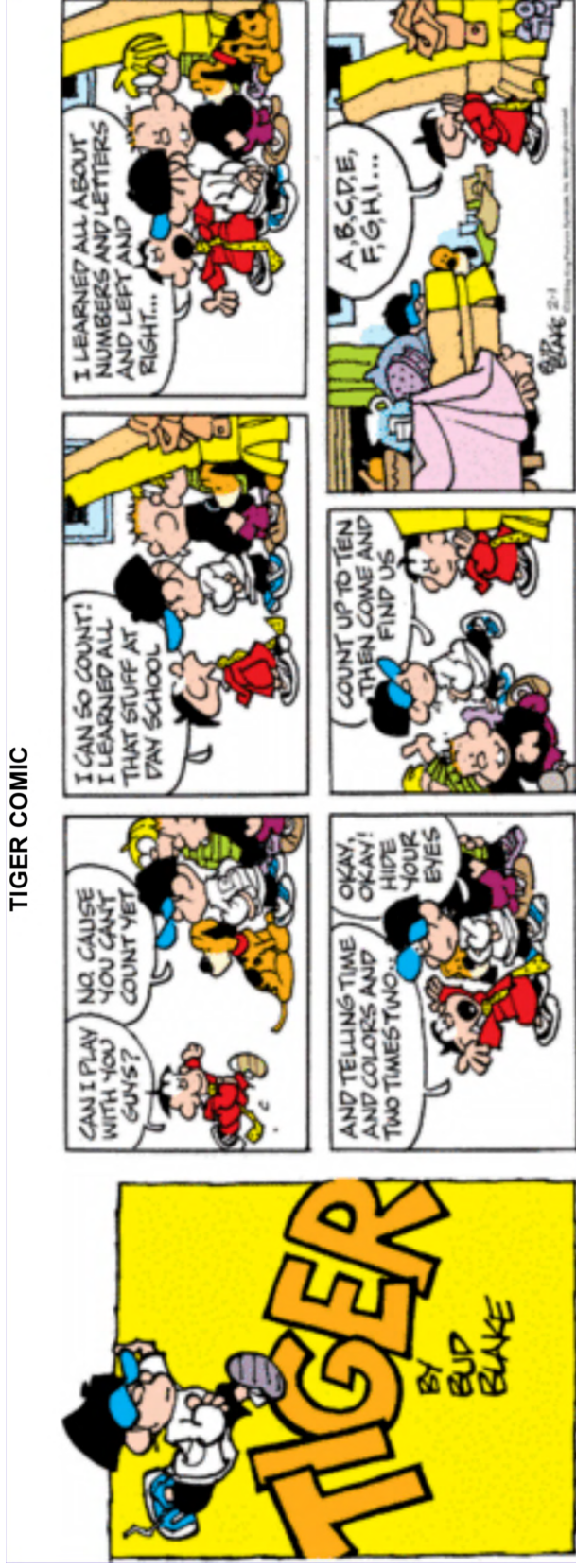

Figure A-1 Hide and Seek

Note. From *Tiger Comics* by B. Blake. Retrieved March 10, 2009, from <http://www.kingfeatures.com/features/comics/tiger/about.html>

THIS PAGE INTENTIONALLY LEFT BLANK

LEARNING PYRAMID



Figure B-1 Learning Pyramid

Note. From *Engage Educate Empower*, 2007, Copyright by Life Adventure Centre 2009. Retrieved March 11, 2009, from <http://www.lifeadventure center.org>

THIS PAGE INTENTIONALLY LEFT BLANK

DEVELOPMENTAL PERIODS CONFIRMATION

Cut out each strip and place in an envelope. Use page C-3 as a reference during the activity.

12–14 years Experience-Based

Effective learning experiences for cadets at this stage should be achievable, active and fun.

It is important to note that these cadets are just developing the area of the brain associated with higher level thinking skills.

Require close supervision.

Activities in the lesson should end in the same lesson.

DEVELOPMENTAL PERIODS CONFIRMATION

Cut out each strip and place in an envelope. Use page C-3 as a reference during the activity.

15–16 years Developmental

Cadets in this stage are ready to start learning about and practising reasoning and problem-solving skills.

Cadets want to practise and explore new thinking skills

Concerned with fairness; the value system kicks in where they need equality for all.

Cadets ask question like "how do I fit in?" and "how does this affect me?"

DEVELOPMENTAL PERIODS CONFIRMATION ANSWER KEY

12–14 years Experience-Based

Effective learning experiences for cadets at this stage should be achievable, active and fun.

It is important to note that these cadets are just developing the area of the brain associated with higher level thinking skills.

Require close supervision.

Activities in the lesson should end in the same lesson.

15–16 years Developmental

Cadets in this stage are ready to start learning about and practising reasoning and problem-solving skills.

Cadets want to practise and explore new thinking skills

Concerned with fairness; the value system kicks in where they need equality for all.

Cadets ask question like "how do I fit in?" and "how does this affect me?"

THIS PAGE INTENTIONALLY LEFT BLANK

LEARNING STYLES INFORMATION SHEET

Understanding the different learning styles can help make a more effective instructor. For example, being aware of how cadets process information allows the instructor to design lessons and activities that present information in a variety of ways to address as many learning styles as possible. Learning occurs using the senses. The three learning styles use seeing, hearing and touching. Seeing corresponds to visual learners, hearing corresponds to auditory learners and touching corresponds to kinaesthetic learners.

| | | |
|---|---|---|
| <p>Visual Learners:</p> <ul style="list-style-type: none"> • are described as readers and observers; • learn through seeing; • think in pictures; • benefit from and enjoy visual aids; and • are better at reading than listening. | <p>Auditory Learners:</p> <ul style="list-style-type: none"> • are described as listeners and talkers; • process information through their ears; • are good working in louder environments; • are great socialisers; and • need to ask questions to confirm learning. | <p>Kinaesthetic Learners:</p> <ul style="list-style-type: none"> • are described as doers; • learn through moving, touching and doing; • process information through their muscles; and • learn best when combining muscles with reading or talking. |
|---|---|---|

Figure D-1 Learning Styles

Note. Adapted from *Cadet Program Reference Guide*. Created by Director Cadets 3, 2009, Ottawa, ON: Department of National Defence.

The differences between the three learning styles are illustrated in Figure D-2.

| | VISUAL | AUDITORY | KINAESTHETIC |
|-----------------------------|--|---|---|
| Decision Making | Create a chart of the possible alternatives; write out pros / con. | Talk over options with a friend. | Try out options—go with the path that seems best. |
| Asking Directions | Prefer a map / written directions. | Prefer verbal instructions. | Prefer to have someone take them the first time. |
| Learning a New Skill | Watch someone else do it, follow a diagram in a manual. | Attend a lecture; have someone talk them through the steps. | Try this and that until it works. |

Figure D-2 Learning Styles and Instructional Activities

Note. From *Cognitive Preference*. Retrieved March 10, 2009, from <http://www.georgebrown.ca/saffairs/stucuss/learningstyles.aspx>.

To process information, a combination of the three senses are used, signifying that no learning style is completely independent. Each individual has a dominant learning style that represents how they process information most / how they learn best. Most of the population learn best by seeing and are therefore visual learners. When preparing a lesson, the instructor must keep in mind that it is best to provide multiple opportunities for all three styles of learning.



Figure D-3 Dominant Learning Style

Note. Adapted from *Cadet Program Reference Guide*. Created by Director Cadets 3, 2009, Ottawa, ON: Department of National Defence.

LEARNING STYLES SURVEY

Directions. Select the answer that describes you best. There can only be one answer for each question. Once all the questions are answered, tally each of the letters, V, A and K to find your learning style.

1. If I have to learn how to do something, I learn best when I:

- (V) watch someone show me how.
- (A) hear someone tell me how.
- (K) try to do it myself.

2. When I read, I often find that I:

- (V) visualize what I am reading in my mind's eye.
- (A) read aloud or hear the words inside my head.
- (K) fidget and try to "feel" the content.

3. When asked to give directions, I:

- (V) see the actual places in my mind as I say them or prefer to draw them.
- (A) have no difficulty in giving them verbally.
- (K) have to point or move my body as I give them.

4. If I am unsure how to spell a word, I:

- (V) write it in order to determine if it looks right.
- (A) spell it out loud in order to determine if it sounds right.
- (K) write it in order to determine if it feels right.

5. When I write, I:

- (V) am concerned with how neat and well spaced my letters and words appear.
- (A) often say the letters and words to myself.
- (K) push hard on my pen or pencil and can feel the flow of the words or letters as I form them.

6. If I had to remember a list of items, I would remember it best if I:

- (V) wrote them down.
- (A) said them over and over to myself.
- (K) moved around and used my fingers to name each item.

7. I prefer teachers who:

- (V) use the board or overhead projector while they lecture.
- (A) talk with a lot of expression.
- (K) use hands-on activities.

8. When trying to concentrate, I have a difficult time when:

- (V) there is a lot of clutter or movement in the room.
- (A) there is a lot of noise in the room.
- (K) I have to sit still for any length of time.

9. When solving a problem, I:

- (V) write or draw diagrams to see it.
- (A) talk myself through it.
- (K) use my entire body or move objects to help me think.

10. When given written instructions on how to build something, I:

- (V) read them silently and try to visualize how the parts will fit together.
- (A) read them out loud and talk to myself as I put the parts together.
- (K) try to put the parts together first and read later.

11. To keep occupied while waiting, I:

- (V) look around, stare, or read.
- (A) talk or listen to others.
- (K) walk around, manipulate things with my hands, or move / shake my feet as I sit.

12. If I had to verbally describe something to another person, I would:

- (V) be brief because I do not like to talk at length.
- (A) go into great detail because I like to talk.
- (K) gesture and move around while talking.

13. If someone were verbally describing something to me, I would:

- (V) try to visualize what they were saying.
- (A) enjoy listening but want to interrupt and talk myself.
- (K) become bored if their description got too long and detailed.

14. When trying to recall names, I remember:

- (V) faces but forget names.
- (A) names but forget faces.
- (K) the situation that I met the person other than the person's name or face.

Scoring Instructions: Add the number of responses for each letter and enter the total below. The area with the highest number of responses is your primary style of learning.

Visual V = _____ Auditory A = _____ Kinaesthetic K = _____

Figure E-1 Survey

Note. From *Learning Styles*. Retrieved March 16, 2009, from <http://www.georgebrown.ca/saffairs/stusucc/learningstyles.aspx>

HOW TO MAKE A JUMPING FROG

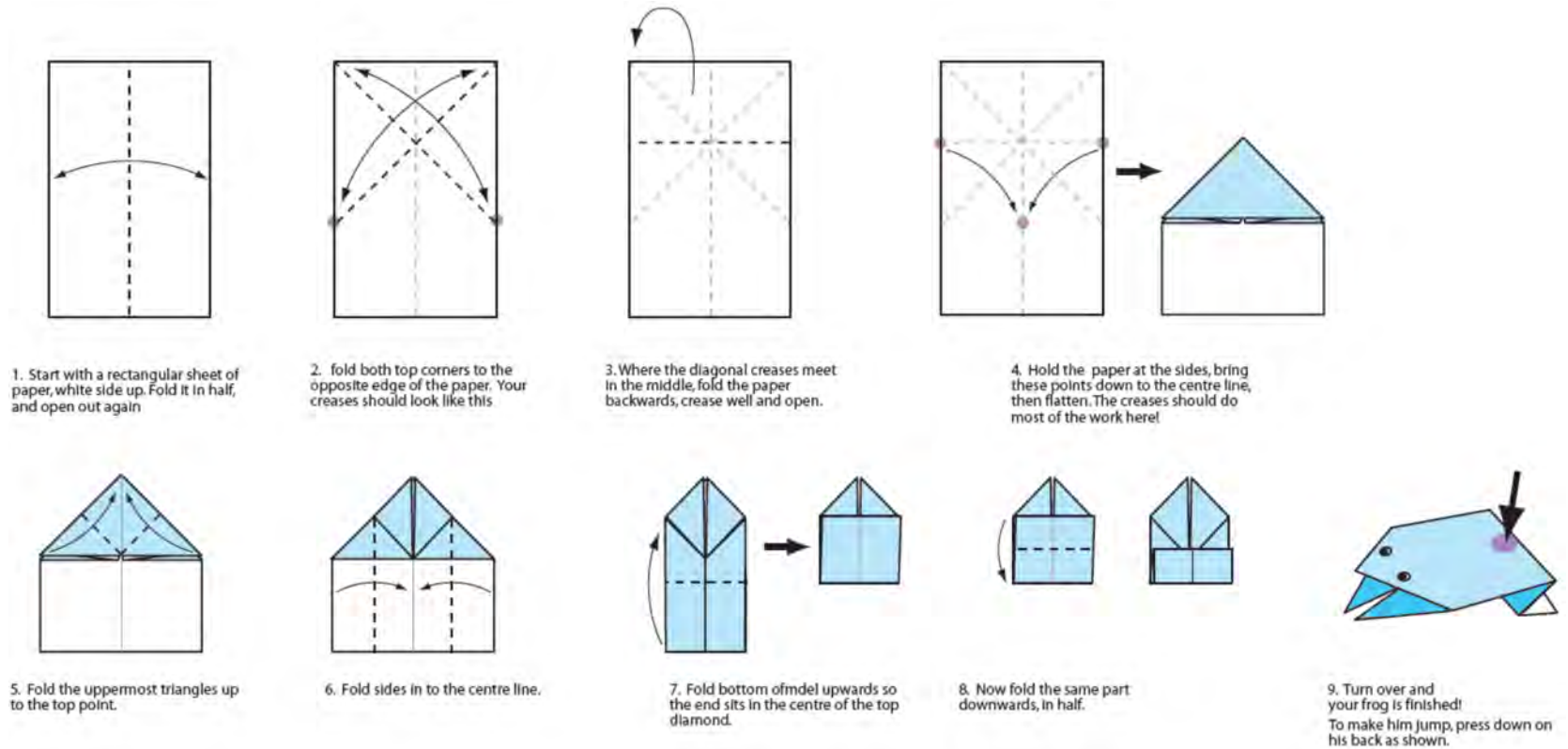
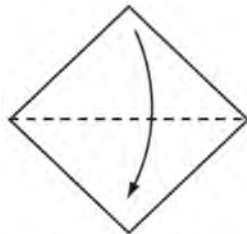

Figure F-1 Jumping Frog

Note. From *Origami-Fun*. Retrieved March 10, 2009, from <http://www.origami-fun.com>

THIS PAGE INTENTIONALLY LEFT BLANK

HOW TO MAKE A TRIANGULAR BOX



1. Start with a square piece of paper, plain side up.
Fold the paper in half.



2. Fold the top corners toward the bottom point, then open to create these creases.



3. Fold both layers of the bottom point up to the top of the model, then open.



4. This is one completed unit, You need three. So make 2 more of these!

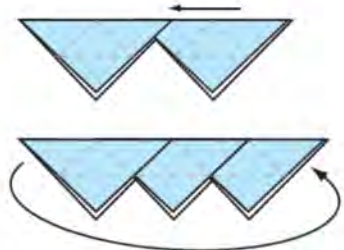

5. Insert one unit inside the other, then link the units all together.



Completed Triangle Box

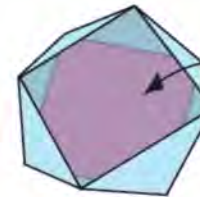

4 sided Triangle Box



You can also make boxes with more than three units.

If you join four units together, you will have a lovely box with a square opening...

If you join 5 units together, you will have a box with a pentagon shaped opening.

Note: boxes with more than 3 units will need a bit of paper on the base as the units will not quite touch.

Cut out a square piece of paper to glue to the bottom of the box. This will cover up the hole and look neat!

The square should be the same size as the opening of the box, so measure the edges to get a perfect fit.

Figure G-1 Triangular Box

Note. From *Origami-Fun*. Retrieved March 10, 2009, from <http://www.origami-fun.com>

THIS PAGE INTENTIONALLY LEFT BLANK

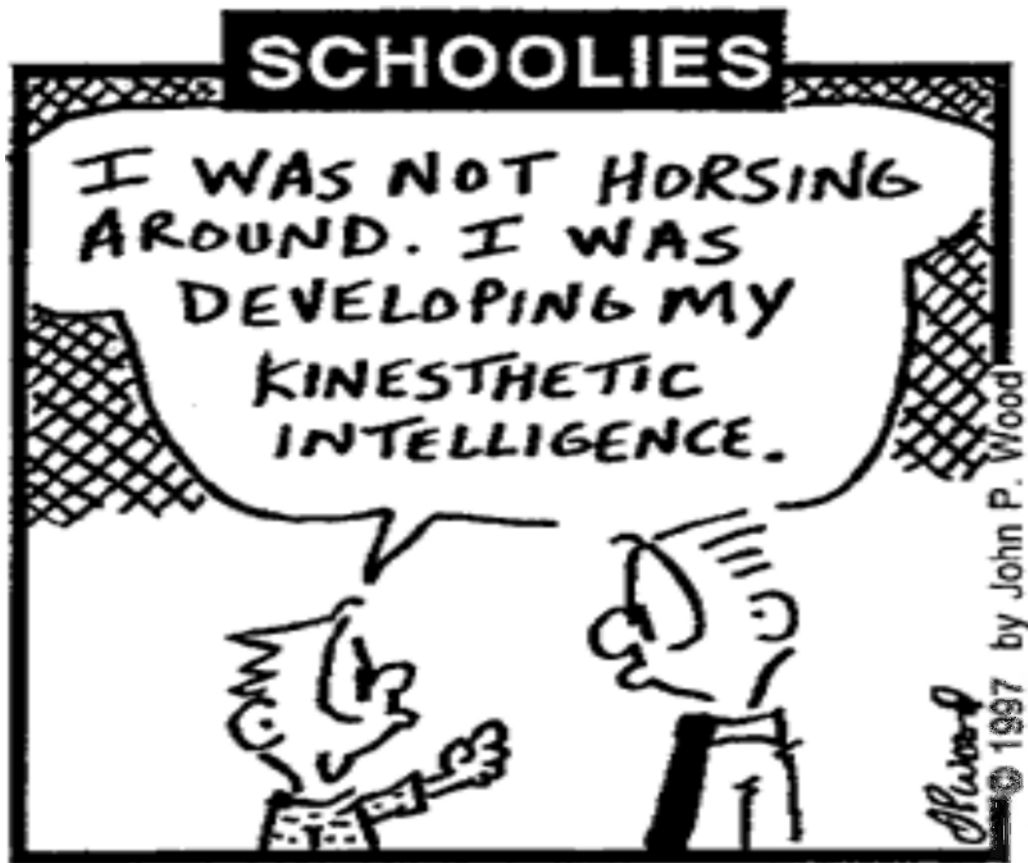

Figure H-1 Kinesthetic Learning

Note. From *Schoolies*, 1997, Copyright 1997 by J. Wood. Retrieved from <http://www.learninglaffs.com>

THIS PAGE INTENTIONALLY LEFT BLANK

INSTRUCTOR TIPS FOR LEARNING STYLES

Directions: Match each instructor tip with the correct learning style. Use V for Visual, A for Auditory, and K for Kinaesthetic.

1. _____ Allow cadets to sit where they can see clearly.
2. _____ Allow the cadets to get up and move.
3. _____ Use hands-on activities.
4. _____ Provide movement as part of the lesson.
5. _____ Buddy up to teach each other.
6. _____ Use items that can be handled and moved.
7. _____ Allow the cadets to sit where they can hear clearly.
8. _____ Read aloud written material.
9. _____ Keep visual aids in view long enough to be seen and referred back to.
10. _____ Use presentations, mutuels and speeches.
11. _____ Follow a written agenda and provide written material to be followed.
12. _____ Write out directions.
13. _____ Provide a space where they can read questions aloud to themselves before they write them down.
14. _____ Allow the cadets to do what is asked for, not to describe it.
15. _____ Provide discussion opportunities.
16. _____ Use rhymes, mnemonics and acronyms.
17. _____ Slow down and repeat when giving verbal information.
18. _____ Change pitch, tone and speed for emphasis.
19. _____ Avoid meaningless movement and decorations.
20. _____ Use posters, pictures, models, real items, and people.
21. _____ Have the cadets repeat things back.
22. _____ Use real items in context.
23. _____ Provide a space with few distractions.
24. _____ Allow matching or reorganizing rather than naming.
25. _____ Slow down, repeat and use only necessary words when asking verbal questions.
26. _____ Provide opportunity for written responses.
27. _____ Provide space to move around.
28. _____ Provide opportunity for verbal responses.
29. _____ Allow them to talk to themselves and whisper when they read.

THIS PAGE INTENTIONALLY LEFT BLANK

INSTRUCTOR TIPS FOR LEARNING STYLES ANSWER KEY

Directions: Match each instructor tip with the correct learning style. Use V for Visual, A for Auditory, and K for Kinaesthetic.

1. V Allow cadets to sit where they can see clearly.
2. K Allow the cadets to get up and move.
3. K Use hands on activities.
4. K Provide movement as part of the lesson.
5. A Buddy up to teach each other.
6. K Use items that can be handled and moved.
7. A Allow the cadets to sit where they can hear clearly.
8. A Read aloud written material.
9. V Keep visual aids in view long enough to be seen and referred back to.
10. A Use presentations, mutuels and speeches.
11. V Follow a written agenda and provide written material to be followed.
12. V Write out directions.
13. A Provide a space where they can read questions aloud to themselves before they write it down.
14. K Allow the cadets to do what is asked for, not to describe it.
15. A Provide discussion opportunities.
16. A Use rhymes, mnemonics and acronyms.
17. V Slow down and repeat when giving verbal information.
18. A Change pitch, tone and speed for emphasis.
19. V Avoid meaningless movement and decorations.
20. V Use posters, pictures, models, real items, and people.
21. A Have the cadets repeat things back.
22. K Use real items in context.
23. V Provide a space with few distractions.
24. K Allow matching or reorganizing rather than naming.
25. V Slow down, repeat and use only necessary words when asking verbal questions.
26. A Provide opportunity for written responses.
27. K Provide space to move around.
28. A Provide opportunity for verbal responses.
29. A Allow them to talk to themselves and whisper when they read.

THIS PAGE INTENTIONALLY LEFT BLANK

ACTIVITIES IN DEVELOPMENTAL PERIODS

Read each statement and determine what developmental period is being described. Draw an arrow to the correct column.

| Ages 12–14 | Activity Description | Ages 15–16 |
|-------------------------------|--|---------------------------|
| DP 1 Experienced-Based | | DP 2 Developmental |
| | Clear / simple processes. | |
| | Provide reasons for the activity. | |
| | Provide some structure (eg, the instructor chooses the groups but leaves some choices to the group). | |
| | Closely supervised. | |
| | Semi-independent and less supervised. | |
| | Clear goals with some choice in process. | |
| | Very structured. | |
| | Lots of play. | |
| | Trial and error activities. | |
| | Clear and concrete goals (eg, one goal / one activity). | |
| | Provide reasons for the activity. | |
| | Will not require an instant result at the end of the first session. Can stretch the activity over 2–3 lessons. | |
| | Results oriented. | |
| | Formal, effective assessment is appropriate. Begin to develop skills in self assessment. | |
| | Assessment should focus on participation and observation. | |
| | Short learning sessions. | |

THIS PAGE INTENTIONALLY LEFT BLANK

ACTIVITIES IN DEVELOPMENTAL PERIODS ANSWER KEY

Read each statement and determine what developmental period is being described. Draw an arrow to the correct column.

| Ages 12–14 | Activity Description | Ages 15–16 |
|------------------------|--|--------------------|
| DP 1 Experienced-Based | | DP 2 Developmental |
| ← | Clear / simple processes. | |
| | Provide reasons for the activity. | → |
| | Provide some structure (eg, the instructor chooses the groups but leaves some choices to the group). | → |
| ← | Closely supervised. | |
| | Semi-independent and less supervised. | → |
| | Clear goals with some choice in process. | → |
| ← | Very structured. | |
| ← | Lots of play. | |
| ← | Trial and error activities. | |
| ← | Clear and concrete goals (eg, one goal / one activity). | |
| | Provide reasons for the activity. | → |
| | Will not require an instant result at the end of the first session. Can stretch the activity over 2–3 lessons. | → |
| ← | Results oriented. | |
| | Formal, effective assessment is appropriate. Begin to develop skills in self assessment. | → |
| ← | Assessment should focus on participation and observation. | |
| ← | Short learning sessions. | |

THIS PAGE INTENTIONALLY LEFT BLANK



**COMMON TRAINING
GOLD STAR
INSTRUCTIONAL GUIDE**



SECTION 4

EO M409.04 – EXPLAIN ASSESSMENT

Total Time:

30 min

PREPARATION

PRE-LESSON INSTRUCTIONS

Resources needed for the delivery of this lesson are listed in the lesson specification located in A-CR-CCP-704/PG-001, *Gold Star Qualification Standard and Plan*, Chapter 4. Specific uses for said resources are identified throughout the instructional guide within the TP for which they are required.

Review the lesson content and become familiar with the material prior to delivering the lesson.

PRE-LESSON ASSIGNMENT

Photocopy the Assessment of Learning Plan located at Attachment A for each cadet.

Photocopy the Assessment Instructions located at Attachment B for each cadet.

Photocopy the assessment instruments located at Attachments C, D and E for each cadet.

APPROACH

An interactive lecture was chosen for this lesson as a way to introduce the cadets to assessment types, instructions and instruments, provoke thought and stimulate interest among cadets.

INTRODUCTION

REVIEW

Nil.

OBJECTIVES

By the end of this lesson the cadet shall have explained assessment.

IMPORTANCE

It is important for cadets to know the different types of assessment and how to use assessment tools to create a positive learning environment. Varying the method of assessment is one way for instructors to create interest and encourage learning.

Teaching Point 1**Explain types of assessment.**

Time: 10 min

Method: Interactive Lecture

ASSESSMENT OF LEARNING

Assessment of learning is the predominant type of assessment used following instruction / learning. It is a summative type of assessment that is used to report on progress made by cadets, usually by showing the instructor a cadet's relative position compared to other cadets. Assessment of learning usually takes the form of questions and answers compiled in a test or quiz. The questions are from the lesson that was taught and typically performed at the end of an instruction unit.

Tests are used to measure quantity and accuracy of student progress with little or no direction and advice for improvement. This type of testing shows which students are doing well and which are doing poorly. Although these testing techniques are simplistic, they can be a good indication of a cadet's mastery of skills and knowledge. They are not always a good indication of the ideas or concepts covered.

Within the Canadian Cadet Organizations (CCO), assessment of learning takes place to determine whether learners have achieved Performance Objectives (PO) or critical Enabling Objectives (EO) (those deemed prerequisites for further training and education) and are used at the end of a phase of instruction. Every opportunity should be given to cadets to be successful in their assessment, even if multiple challenges are required.

ASSESSMENT FOR LEARNING

Assessment for learning is ongoing assessment used during instruction. It is a formative type of assessment and is used to create descriptions of the cadet's knowledge on the subject matter. These descriptions are used to determine if the instructor needs to review information and where the weak areas are in the lesson. This information can also be used to provide feedback to the cadet regarding their strengths and areas for improvement.

Assessment instruments used during assessment for learning include:

- worksheets,
- checklists,
- in-class activities, and
- questions and observations.

In assessment for learning, the instructor is the central character that will use the information obtained to design and develop the next stage of instruction.

Within the CCO, assessment for learning takes place during a phase of instruction and helps cadets and instructors recognize progress or lapses in learning. Through assessment for learning, the instructor can:

- identify when corrective or remedial action is required;
- plan the next steps in instruction;
- provide cadets with feedback so they can improve; and
- reinforce learning to aid the cadet in retaining information.

Assessment for learning may also include opportunities for cadets to practice using Performance Checks (PC) employed in assessment of learning.



A simple comparison of assessment types can be made as follows:

When a cook tastes the soup, that is formative (assessment for) and allows them to adjust spices to change the flavour to improve the taste; when the guests taste the soup, that is summative (assessment of) and allows them to make a judgement of the quality of the soup.

CONFIRMATION OF TEACHING POINT 1

QUESTIONS:

- Q1. What type of assessment is assessment for learning?
- Q2. What does assessment for learning (formative) give the instructor the ability to do?
- Q3. Why does assessment of learning (summative) take place?

ANTICIPATED ANSWERS:

- A1. Formative.
- A2. Identify when corrective or remedial action is required, plan the next steps in instruction, provide cadets with feedback so they can improve, and reinforce learning to aid the cadet in retaining information.
- A3. To determine whether learners have achieved POs or critical EOs (those deemed prerequisites for further training and education).

Teaching Point 2

Describe assessment instructions and instruments.

Time: 15 min

Method: Interactive Lecture

Assessment for learning takes place throughout the learning process and guides the instructor in lesson planning; assessment of learning takes place upon completion of the learning phase. Chapter 3 of the Qualification Standard and Plan (QSP) outlines the assessment of learning plan and the assessment instruments to be used.



All attachments for this lesson are taken from A-CR-CCP-703/PG-001, *Silver Star Qualification Standard and Plan*, Chapter 3. Details of assessment are located in Chapter 3 of all QSPs.

CADET ASSESSMENT OF LEARNING PLAN



Distribute the Assessment of Learning Plan located at Attachment A to each cadet.

The Assessment of Learning Plan located at Chapter 3, Annex B of the QSP, provides an overall strategy for using assessment activities to determine if the cadet has met the requirements for qualification. The assessment of learning plan will:

1. provide an outline of each assessment of learning activity including its purpose, when it will occur and details the assessment instrument(s) used to support cadet evaluation;
2. identify the learning target(s) associated with the PO and / or EO being assessed, to include:
 - a. **Knowledge Mastery.** The facts, concepts and theory a cadet needs to know;
 - b. **Reasoning Proficiency.** A cadet uses what they know to solve a problem, make a decision, make a plan, think critically, set goals, or self-assess;
 - c. **Skills.** Performance demonstration where the cadet demonstrates their ability to perform a skill. To be assessed, these performances must be demonstrated by the cadet and observed by an assessor;
 - d. **Ability to Create Products.** A cadet uses their knowledge, reasoning and skills to create a concrete product; and / or
 - e. **Attitudinal / Dispositional Changes.** A cadet's attitude about learning, safety, conduct, etc. Targets in this realm reflect attitude and feeling. They represent important affective goals we hold for a cadet as a by-product of their CP experience, and as such are not generally assessed for the purpose of attaining a qualification.
3. identify the assessment method(s) that best matches PO and / or EO learning targets, to include:
 - a. **Selected Response.** A cadet selects the correct or best response from a list provided. Formats include multiple choice, true / false, matching, short answer, and fill-in-the-blank questions. Although short answer and fill-in-the-blank questions do require cadets to generate an answer, they call for a very brief answer that is counted as right or wrong, so these have been included in the selected response category;
 - b. **Extended Written Response.** A cadet is required to construct a written answer in response to a question or task rather than select one from a list. An extended written response is one that is at least several sentences in length;
 - c. **Performance Assessment.** This assessment method is based on observation and judgment; performance or product is observed and a determination is made as to its quality; and / or
 - d. **Personal Communication.** Gathering information about a cadet through personal communication; learning is assessed through interpersonal interaction with the cadet.

ASSESSMENT INSTRUMENTS

Specific assessment instruments are designed to support each assessment activity within the assessment of learning plan. These are meant to standardize assessment activities and cadet evaluation for all cadets attempting the qualification. Assessment instruments are located at the appendices to Chapter 3, Annex B of the QSP.



Distribute the Assessment Instructions located at Attachment B to each cadet.

Assessment instructions are provided to guide the instructor through the steps of the assessment to ensure consistent conduct of all assessments.



Using the Assessment Instructions handout, discuss with the cadets the information located in it, to include:

- preparation,
- conduct of assessment, and
- post-assessment instructions.



Distribute the assessment instruments located at Attachments C, D and E to each cadet. Discuss with the cadets how to use each of these assessment instruments.

Assessment is conducted to ascertain levels of learning. In most cases, these levels are defined in the Assessment Instructions. The most common assessment instruments used in the CCO are rubrics, individual checklists, and group checklists.

Rubric. A scoring tool that lists criteria to be considered for assessment. It is designed to guide the individual assessor's interpretation by providing a description of what should be observed for each level of proficiency and should be as clear and concise as practical.

Checklists. A simple checkbox type of worksheet that shows success in given tasks. Checklists can be designed to assess both individuals or groups.

CONFIRMATION OF TEACHING POINT 2

QUESTIONS:

- Q1. What does the Assessment of Learning Plan provide?
- Q2. What are the three parts of the Assessment Instructions?
- Q3. What is a rubric?

ANTICIPATED ANSWERS:

- A1. An overall strategy for using assessment activities to determine if the cadet meets the requirements.
- A2. Preparation, conduct of assessment and post-assessment instructions.
- A3. A scoring tool that lists criteria to be considered for assessment. It is designed to guide the individual assessor's interpretation by providing a description of what should be observed for each level of proficiency and should be as clear and concise as practical.

END OF LESSON CONFIRMATION**QUESTIONS:**

- Q1. Where in the QSP can information on assessment be found?
- Q2. When does assessment for learning (formative assessment) take place?
- Q3. What is the purpose of the Assessment Instructions?

ANTICIPATED ANSWERS:

- A1. In Chapter 3 of the QSP.
- A2. Ongoing throughout the lesson.
- A3. To guide the instructor through the steps of the assessment to ensure consistent conduct of all assessments.

CONCLUSION

HOMEWORK / READING / PRACTICE

Nil.

METHOD OF EVALUATION

This EO is assessed IAW A-CR-CCP-704/PG-001, *Gold Star Qualification Standard and Plan*, Chapter 3, Annex B, 409 PC.

CLOSING STATEMENT

Being familiar with assessment requirements will allow the instructor to be better prepared to meet the requirements of the lesson.

INSTRUCTOR NOTES / REMARKS

Nil.

REFERENCES

A2-067 A-CR-CCP-703/PG-001 Director Cadets 3. (2008). *Silver star qualification standard and plan*. Ottawa, ON: Department of National Defence.

C0-376 ISBN 0-7619-4626-8 Earl, L. (2003). *Assessment as learning*. Thousand Oaks, CA: Corwin Press, Inc.

Annex A
Assessment of Learning Plan – Silver Star

| EC / PC | Scope | Purpose | Target | Method | How | When | Resources | Limitations |
|---|--------|---|---|---|---|---|---|-----------------------|
| PO 301 – Recognize the Purpose of Service Groups Within Canada | | | | | | | | |
| Nil. | | | | | | | | |
| PO 302 – Perform Community Service | | | | | | | | |
| Nil. | | | | | | | | |
| PO 303 – Perform the Role of a Team Leader | | | | | | | | |
| 303 PC | PO 303 | The purpose of this PC is to assess the cadet's ability to perform the role of team leader. | Reasoning proficiency and skills | Performance assessment and personal communication | The cadet is observed performing the role of a team leader. The performance is then discussed with the cadet. | On completion of lessons related to EO M303.07 then ongoing throughout the training year. | Chapter 3, Annex B, Appendix 1 checklist and associated rubric. | Nil. |
| PO 304 – Update Personal Activity Plan | | | | | | | | |
| Nil. | | | | | | | | |
| PO 305 – Participate in Recreational Sports | | | | | | | | |
| Nil. | | | | | | | | |
| PO 306 – Fire the Cadet Air Rifle During Recreational Marksmanship | | | | | | | | |
| Nil. | | | | | | | | |
| PO 307 – Serve in an Army Cadet Corps | | | | | | | | |
| Nil. | | | | | | | | |
| PO 308 – Direct a Squad Prior to a Parade | | | | | | | | |
| 308 PC | PO 308 | To assess the cadet's ability to prepare a squad for parade. | Skills | Performance assessment | The cadet is observed as they prepare a squad for parade by: forming up, sizing, dressing, inspecting and calling the roll. | During preparation for corps opening and closing parades. | Chapter 3, Annex B, Appendix 2 checklist. | Nil. |
| PO 309 – Instruct a Lesson | | | | | | | | |
| 309 PC | PO 309 | To assess the cadet's ability to instruct a lesson using a written | Ability to create product and reasoning proficiency | Performance assessment | The cadet's lesson plan is reviewed and they are | Ongoing during the conduct of EO M309.07. | Chapter 3, Annex B, Appendix 3 | Assistance is denied. |

| EC / PC | Scope | Purpose | Target | Method | How | When | Resources | Limitations |
|---|------------|---|----------------------------|---------------------------|---|-----------------------------|---|--|
| | | lesson plan, an appropriate method(s) of instruction and an appropriate instructional aid(s). | | | observed while instructing a 15-minute lesson. | | checklist and rubric. | |
| PO 320 – Recognize the Valour of Members of the Canadian Army | | | | | | | | |
| Nil. | | | | | | | | |
| PO 321 – Perform the Duties of a Team Leader on a Weekend Bivouac Exercise | | | | | | | | |
| Nil. | | | | | | | | |
| PO 322 – Plot Location on a Topographical Map Using a Global Positioning System Receiver | | | | | | | | |
| 322 EC-01 | EO M322.02 | To assess the cadet's ability to calculate current magnetic declination from the information provided on a topographical map. | Reasoning proficiency | Extended written response | The cadet is presented with a topographical map and is required to correctly calculate the current magnetic declination in degrees. | Confirmation to EO M322.02. | Chapter 3, Annex B, Appendix 4 worksheet. | Nil. |
| 322 PC | PO 322 | To assess the cadet's ability to plot their position on a topographical map with a grid reference calculated by a GPS unit. | Reasoning proficiency | Performance assessment | The cadet shall identify their grid reference from the data provided by a GPS unit and then plot that position on a topographical map within 100 m of accuracy. | During M322.06. | Chapter 3, Annex B, Appendix 5 checklist. | Nil. |
| PO 324 – Survive When Lost | | | | | | | | |
| 324 EC-01 | EO M324.01 | To assess the cadet's ability to build an improvised shelter in | Ability to create products | Performance assessment | Shelters constructed by cadets in pairs shall be assessed to | During the bivouac FTX. | Chapter 3, Annex B, Appendix 6 checklist. | To limit environmental impact, the cadet shall be required |

| EC / PC | Scope | Purpose | Target | Method | How | When | Resources | Limitations |
|-----------|------------|---|----------------------------|-------------------------|--|-------------------------|---|--|
| | | a survival situation. | | | ensure they will provide adequate protection from the elements in a survival situation. | | | to use a half-shelter (ground sheet) in place of boughs. |
| 324 EC-02 | EO M324.02 | To assess the cadet's ability to collect water in a survival situation. | Skills | Performance assessment | The cadet shall construct and gather water from an improvised water collection source. | During the bivouac FTX. | Chapter 3, Annex B, Appendix 6 checklist. | To limit environmental impact, the cadet shall be required to return the environment to a natural state (e.g. fill holes, etc) following this EC. |
| 324 EC-03 | EO M324.03 | To assess the cadet's ability to ignite a fire without the use of matches or a lighter in a survival situation. | Ability to create products | Performance assessment | The cadet shall be assessed on using the correct process to ignite a fire using one of: flint and steel, bow and drill, fire saw, or sun and glass method. | During the bivouac FTX. | Chapter 3, Annex B, Appendix 6 checklist. | To limit environmental impact, the cadet shall be limited in the number of simultaneous evaluations that shall take place. The cadet is assessed on process used not successfully lighting a fire. |
| 324 EC-04 | EO M324.04 | To assess the cadet's ability to predict weather by observing cloud formations and weather patterns. | Reasoning proficiency | Personal communications | The cadet shall be asked to observe the current environmental conditions and to predict the weather based on their | During the bivouac FTX. | Chapter 3, Annex B, Appendix 6 checklist. | The cadet shall be assessed on process used not successfully predicting the weather. |

| EC / PC | Scope | Purpose | Target | Method | How | When | Resources | Limitations |
|---|--------|---|--------|------------------------|---|--|---|-------------|
| | | | | | observations. Additional follow up questions may be asked to probe the cadet's reasoning ability. | | | |
| <i>PO 325 – Identify the Competencies of an Outdoor Leader</i> | | | | | | | | |
| Nil. | | | | | | | | |
| <i>PO 326 – Perform Expedition Skills</i> | | | | | | | | |
| 326 PC | PO 326 | To assess the cadet's ability to perform expedition skills. | Skills | Performance assessment | Cadets are observed to ensure they can perform expedition skills to include: employing two methods of transportation, supervising environmental stewardship, navigating along a route, utilizing expedition equipment, following daily routine, and recording entries in a journal. | During the PO 326 Expedition Centre FTX. | Chapter 3, Annex B, Appendix 7 checklist and associated rubric. | Nil. |

ANNEX B, APPENDIX 1
303 PC
ASSESSMENT INSTRUCTIONS

PREPARATION

PRE-ASSESSMENT INSTRUCTIONS

Review the assessment plan, assessment instructions and 303 PC Assessment Rubric and become familiar with the material prior to conducting the assessment.

There is no time allotted for 303 PC. It is to be administered whenever and wherever Silver Star cadets lead cadets through a leadership assignment.

The cadet shall be given a minimum of one practice leadership assignment which will be assessed using the 303 PC Assessment Rubric. The cadet will reflect and self-assess after the practice leadership assignment using the same rubric. The practice leadership assignment will not be recorded on the cadet's qualification record.

The formal leadership assignment will be given and assessed using the 303 PC Assessment Rubric. The cadet will reflect and self-assess after the leadership assignment using the same rubric. The leadership assignment shall be recorded on the cadet's qualification record.

If the cadet does not achieve the performance standard, the cadet will be given additional leadership assignments until the performance standard is met.

Photocopy the 303 PC Assessment Rubric twice for each leadership assignment given.

PRE-ASSESSMENT ASSIGNMENT

The cadet shall review the 303 PC Assessment Rubric and become familiar with the assessment criteria prior to the leadership assignment.

ASSESSMENT METHOD

Performance assessment and personal communication were chosen as it allows the assessor to observe the cadet's ability to perform the required skill(s) and make a judgement on the quality of performance.

CONDUCT OF ASSESSMENT

PURPOSE

The purpose of this PC is to assess the cadet's ability to lead cadets through a leadership assignment.

RESOURCES

- Two 303 PC Assessment Rubrics, and
- As per the leadership assignment.

ASSESSMENT ACTIVITY LAYOUT

As per the leadership assignment.

ASSESSMENT ACTIVITY INSTRUCTIONS



While observing the cadet leading cadets through a leadership assignment, assess the quality of each criterion by indicating (eg, highlighting, circling, note taking) on the Assessment Rubric, the descriptive statement that best represents this judgement. Criteria for the leading through a leadership assignment are assessed as:

- Incomplete;
- Completed with difficulty;
- Completed without difficulty; or
- Exceeded standard.

Make notes of observations to provide descriptive post-assessment feedback.

1. Communicate to the cadet their leadership assignment either verbally or in writing.
2. Ensure the cadet understands the leadership assignment.
3. Distribute the Assessment Rubric to the cadet for self-assessment purposes.
4. Ensure the cadet understands their self-assessment will not be recorded on their qualification record.
5. Have the cadet conduct the leadership assignment.
6. Evaluate the cadet's leadership ability by observation. Record the result (eg, highlighting, circling, note taking) on the Assessment Rubric for each criterion.



The assessment of leadership abilities is subjective; however, the assessor's responsibility is to be as positive as possible.

7. Have the cadet assess their performance on their Assessment Rubric.

POST ASSESSMENT INSTRUCTIONS

RECORDING ASSESSMENT RESULTS

1. Indicate the overall performance assessment on the Assessment Checklist as:
 - a. **Incomplete.** Overall, the cadet has not achieved the performance standard;
 - b. **Completed with difficulty.** Overall, the cadet has achieved the performance standard with difficulty;
 - c. **Completed without difficulty.** Overall, the cadet has achieved the performance standard without difficulty; or
 - d. **Exceeded standard.** Overall, the cadet has exceeded the performance standard.
2. Record notes and observations in the assessor's feedback section of the Assessment Checklist.

3. Sign and date the Assessment Checklist.
4. Ensure a copy of the Assessment Checklist is attached to the cadet's training file.
5. The overall result will be recorded on the Silver Star Qualification Record located at Chapter 3, Annex C.

PROVIDING ASSESSMENT FEEDBACK

Discuss the cadet's self-assessment on their performance.

Ask the cadet what they felt went right during the leadership assessment, what did not go well and ask the cadet how they would improve their performance if the leadership assignment was given to them again.

Discuss the performance results of each section of the Assessment Rubric with the cadet.

Discuss the overall performance results with the cadet and provide the cadet with a copy of the completed rubric.

THIS PAGE INTENTIONALLY LEFT BLANK

303 PC ASSESSMENT RUBRIC

Cadet's Name: _____

Corps: _____

Date: _____

Division: _____

| | Incomplete | Completed With Difficulty | Completed Without Difficulty | Exceeded the Standard |
|-------------------------------------|---|---|---|---|
| Communicate as a team leader. | Did not communicate with team members. | Communicated with team members occasionally. Team members needed clarification on many occasions. | Communicated with team members on many occasions. Team members needed few clarifications. | Communicated to the team throughout the leadership task. Team members did not need clarification. |
| Supervise cadets. | Did not supervise cadets. | Only supervised cadets at the beginning and / or end of the leadership assignment. | Supervised throughout the leadership assignment making some corrections when necessary. | Supervised throughout the leadership assignment making corrections as necessary. |
| Solve problems. | Did not solve the problem(s). | | Solved the problem(s). | |
| Complete the leadership assignment. | Did not complete the leadership assignment. | | Completed the leadership assignment. | |
| Perform self-assessment. | Did not complete the self-assessment. | | Completed the self-assessment. | |

This form shall be reproduced locally.

THIS PAGE INTENTIONALLY LEFT BLANK

308 PC ASSESSMENT CHECKLIST

Cadet's Name: _____

Corps: _____

Date: _____

Division: _____

Analytical Performance Assessment:

| Direct a squad prior to a parade | Incomplete | Completed With Difficulty | Completed Without Difficulty |
|--|------------|---------------------------|------------------------------|
| Fall in a squad. | | | |
| Call the roll. | | | |
| Size in a single rank and reform in threes (twos). | | | |
| Dress a squad. | | | |
| Inspect a squad. | | | |
| Hand over a squad. | | | |

Assessor's Feedback

| PO 308 Overall Assessment | | | | | | | |
|----------------------------|--|--|---|--|--|--|-------------------|
| Check One | Incomplete | | Completed With Difficulty | | Completed Without Difficulty | | Exceeded Standard |
| Overall Performance | The cadet has not achieved the performance standard by not completing at least one of the required skills. | | The cadet has achieved the performance standard by completing one or more of the required objectives with difficulty. | | The cadet has achieved the performance standard by completing all objectives without difficulty. | | N/A |

| | |
|------------------------------|------------------|
| Assessor's Name: | Position: |
| Assessor's Signature: | Date: |

This form shall be reproduced locally.

THIS PAGE INTENTIONALLY LEFT BLANK

322 PC ASSESSMENT CHECKLIST

Cadet's Name: _____

Corps: _____

Analytical Performance Assessment:

| Plot position on a topographical map with a grid reference calculated by a GPS receiver. | Assessment | | | |
|---|-------------------|----------------------------------|-------------------------------------|--------------------------|
| | Incomplete | Completed With Difficulty | Completed Without Difficulty | Exceeded Standard |
| The cadet confirmed the correct map datum is set on the GPS receiver. | | | | |
| The cadet located the geographical position page on the GPS receiver and confirmed the grid zone is the same as printed on the topographical map. | | | | |
| The cadet located the geographical position page on the GPS receiver and confirmed the 100 000 m square identifiers are the same. | | | | |
| The cadet read the current 10-figure GR and extracted the 6-figure GR. | | | | |
| The cadet plotted the 6-figure GR on the topographical map of the area. | | | | |
| The cadet confirmed the plotted 6-figure GR that corresponds with the assigned checkpoint. | | | | |

Assessor's Feedback:

| 322 EC 01 ASSESSMENT | | | | | | | |
|-----------------------------|--|--|--|--|---|--|---|
| Overall (Check one) | Incomplete | | Completed With Difficulty | | Completed Without Difficulty | | Exceeded Standard |
| | Overall, the cadet has not attempted to complete the worksheet or did not answer one question correctly. | | Overall, the cadet correctly answered one of the two questions. The task was completed with difficulty and / or required assistance from the assessor. | | Overall, the cadet correctly answered two of the questions without difficulty and / or required minimal assistance from the instructor. | | Overall, the task was completed with no difficulty and no assistance from the assessor. |

THIS PAGE INTENTIONALLY LEFT BLANK



**COMMON TRAINING
GOLD STAR
INSTRUCTIONAL GUIDE**



SECTION 5

EO M409.05 – INSTRUCT A 30-MINUTE LESSON

Total Time:

90 min

THERE IS NO INSTRUCTIONAL GUIDE PROVIDED FOR THIS EO

THIS PAGE INTENTIONALLY LEFT BLANK



**COMMON TRAINING
GOLD STAR
INSTRUCTIONAL GUIDE**



SECTION 6

EO C409.01 – PLAN A LESSON

Total Time:

60 min

THERE IS NO INSTRUCTIONAL GUIDE PROVIDED FOR THIS EO

THIS PAGE INTENTIONALLY LEFT BLANK



**COMMON TRAINING
GOLD STAR
INSTRUCTIONAL GUIDE**



SECTION 7

EO C409.02 – INSTRUCT A 30-MINUTE LESSON

Total Time:

90 min

THERE IS NO INSTRUCTIONAL GUIDE PROVIDED FOR THIS EO

THIS PAGE INTENTIONALLY LEFT BLANK



**COMMON TRAINING
GOLD STAR
INSTRUCTIONAL GUIDE**



SECTION 8

EO C409.03 – ACT AS AN ASSISTANT INSTRUCTOR

Total Time:

90 min

PREPARATION

PRE-LESSON INSTRUCTIONS

Resources needed for the delivery of this lesson are listed in the lesson specification located in A-CR-CCP-704/PG-001, *Gold Star Qualification Standard and Plan*, Chapter 4. Specific uses for said resources are identified throughout the instructional guide within the TP for which they are required.

Review the lesson content and become familiar with the material prior to delivering the lesson.

The course officer shall communicate with the training officer to ensure that cadets are paired with a Green, Red or Silver Star instructor during a regular training session. As part of the training session, the instructor and cadet should be scheduled for two periods of instruction. The time the cadet is not instructing may be used for lesson preparation, briefing, debriefing, securing training aids, etc.

A number of factors may exist based on the size of the corps that will not allow for all Gold Star cadets to be scheduled for this EO at the same time. In this circumstance, special consideration should be given to minimize the cadet's absence from other areas of training. For example, scheduling half of the cadets for this EO while the other half is scheduled for EO C422.03 (Discuss Map Software) and reversing the schedule for the following training session.

PRE-LESSON ASSIGNMENT

Nil.

APPROACH

OJT was chosen for this lesson as it allows the cadet to assist instructing a lesson in a safe and controlled environment. The OJT experience provides the cadet a practical application of learned skills in a realistic setting. The cadet reflects on the experience and receives feedback on the performance, which helps to shape future experiences. The cadet develops a sense of responsibility from the OJT aiding their development as a leader.

INTRODUCTION

REVIEW

Nil.

OBJECTIVES

By the end of this lesson the cadet shall have acted as an assistant instructor.

IMPORTANCE

It is important for cadets to act as an assistant instructor as it gives them the opportunity to practice, observe and assist in performing the duties of an instructor in a safe and controlled environment during a regular training session.

Teaching Point 1**Have the cadets act as assistant instructors in on-the-job training (OJT).**

Time: 90 min

Method: On-The-Job Training

PURPOSE

The purpose of having the cadets act as assistant instructors is to provide them with an authentic experience that allows them to observe and assist in performing the duties of an instructor during a regular training session. This activity is intended to be experiential in nature, providing the cadets the opportunity to work with experienced instructors, with assessment for learning being the focus rather than assessment of learning. When pairing the cadets with an instructor, consideration must be given to such things as the background, specialty and confidence of each cadet while in front of a class. The proper pairing of cadets with an instructor will help to ensure the OJT experience satisfies the stated purpose.

GENERAL INSTRUCTIONS

For one training session the cadets shall be paired with an instructor who is instructing a group of cadets participating in Green, Red or Silver Star training.

The instructor is responsible for the following:

1. Ensure the cadet is briefed on their responsibilities and tasks prior to the commencement of the lesson.
2. Ensure the cadet is provided opportunities to perform some or all tasks normally completed by the instructor, such as:
 - a. **Preparing training aids as required.** The cadet may be asked to gather and prepare training aids.



The focus of this EO should be the development of instructional skills and increasing experience and confidence while in front of a class. The instructor should develop training aids for the lesson. Give the cadet tasks such as setting up presentation aids and organizing training aids, eg, signing out an air rifle for a marksmanship lesson.

- b. **Helping instruct the lesson.** The cadet may be asked to provide a demonstration, assist with the conduct of an in-class activity or instruct a TP of a lesson.
 - c. **Supervising the cadets.** The cadet may be asked to assist with the supervision of the cadets.
 - d. **Providing assistance as required.** The cadet may be asked to provide assistance or assist with skill development by coaching or demonstrating a skill being taught.
 - e. **Securing training aids as required.** Once the lesson is complete, the cadet may be asked to secure and return training aids to storage.
3. If necessary, debrief the (Green, Red or Silver Star) cadets, correcting any content errors or omissions made by the cadet.
4. Debrief the cadet upon completion of the training session and provide them the opportunity to ask questions and seek additional feedback.

CONFIRMATION OF TEACHING POINT 1

The cadets' acting as an assistant instructor will serve as the confirmation of this TP.

END OF LESSON CONFIRMATION

The cadets' acting as an assistant instructor will serve as the confirmation of this lesson.

CONCLUSION

HOMEWORK / READING / PRACTICE

Nil.

METHOD OF EVALUATION

Nil.

CLOSING STATEMENT

Acting as an assistant instructor allows for the development of skills necessary to become a competent instructor by observing, practicing instruction and receiving feedback from an experienced instructor in a safe and controlled environment during a regular training session.

INSTRUCTOR NOTES / REMARKS

Prior to this EO, the course officer shall communicate with the training officer to ensure that cadets are paired with a Green, Red or Silver Star instructor for a regular training session.

A number of factors may exist based on the size of the corps that will not allow for all Gold Star cadets to be scheduled for this EO at the same time. In this circumstance, special consideration should be given to minimize the cadet's absence from other areas of training. For example, scheduling half of the cadets for this EO while the other half is scheduled for EO C422.03 (Discuss Map Software) and reversing the schedule for the following training session.

During this EO the instructor shall:

1. brief the cadet prior to commencing the lesson;
2. assign the cadet tasks, to include:
 - a. preparing training aids as required;
 - b. helping instruct the lesson;
 - c. supervising the cadets;
 - d. providing assistance as required; and
 - e. securing training aids as required;
3. monitor the cadet; and
4. debrief the cadet at the end of the lesson.

REFERENCES

Nil.



**COMMON TRAINING
GOLD STAR
INSTRUCTIONAL GUIDE**



SECTION 9

EO C409.04 – PARTICIPATE IN A CREATIVE LESSON-PLANNING WORKSHOP

Total Time:

90 min

PREPARATION

PRE-LESSON INSTRUCTIONS

Resources needed for the delivery of this lesson are listed in the lesson specification located in A-CR-CCP-704/PG-001, *Gold Star Qualification Standard and Plan*, Chapter 4. Specific uses for said resources are identified throughout the instructional guide within the TP for which they are required.

Review the lesson content and become familiar with the material prior to delivering the lesson.

Photocopy Attachments A–C.

Photocopy and three-hole punch the handouts located at Attachments E–G, J and M for each cadet.

Photocopy Attachment K for each group.

Photocopy and cut out the Benefits of Creative Lessons Phrase Strips located at Attachment I for each group.

Photocopy a sample lesson plan (from Green or Red Star) for each group.

Prepare a piece of flip chart paper by writing the goals of the workshop:

1. define creativity;
2. identify the benefits of a creative lesson;
3. explain the creative process; and
4. incorporate creativity in the lesson-planning process.

Select music to play in the background for the entire workshop.

PRE-LESSON ASSIGNMENT

Ensure the cadets bring the binder provided in EO M409.01 (Identify Methods of Instruction).

APPROACH

An in-class activity was chosen for this lesson as it is an interactive way to provoke thought and stimulate interest in the creative process and how to incorporate creativity into the lesson-planning process.

INTRODUCTION

REVIEW

Nil.

OBJECTIVES

By the end of this lesson the cadet shall have participated in a creative lesson-planning workshop to define creativity, identify the benefits of creative lessons, explain the creative process and learn how to incorporate creative elements into lesson plans.

IMPORTANCE

It is important for cadets to incorporate creative elements into their lesson plans to make their lessons more interesting, enjoyable and engaging for the cadets.

Teaching Point 1**Conduct an activity where the cadets will define creativity.**

Time: 15 min

Method: In-Class Activity

ACTIVITY**OBJECTIVE**

The objective of this activity is to have the cadets define creativity.

RESOURCES

- Mixer worksheet located at Attachment A,
- Pigtire This... worksheet located at Attachment B,
- Cliche Stretching worksheet located at Attachment C,
- Mixer Answer Key located at Attachment D,
- Flip chart paper,
- Markers, and
- Stereo.

ACTIVITY LAYOUT

1. Set up three workstations.
2. Label the workstations as A, B, and C and place flip chart paper and the corresponding attachments at each station.
3. Ensure the lesson location:
 - a. is physically safe;
 - b. allows for manipulation of the physical setting such as lighting, temperature and colour to make it more conducive to learning;
 - c. is large enough to accommodate small group and whole group activities; and
 - d. allows for the incorporation of movement into the lesson.

ACTIVITY INSTRUCTIONS

1. Divide the cadets into equal groups at each station.



Display the chart paper illustrating the worksheet goals.

2. Introduce the goals of the workshop. Read the goals of the workshop together.
3. Instruct the cadets to work in their groups brainstorming ideas about creativity and write their responses on flip chart paper.

4. Instruct the cadets to follow the directions at their station to complete the activity.



Play music in the classroom while the cadets are completing individual and group work.

5. Provide the cadets with two minutes to present an example of their activity and to explain how their activity was creative. Encourage the cadets to use a visual representation of their activity on flip chart paper.
6. Explain to cadets that:
- thinking creatively does not always make sense; and
 - sometimes the brain must think in different ways to find the answer.
7. Present the cadets with the following problem and answer:
- If you throw a ball as hard as you can, how does it come back to you?
 - It doesn't hit anything, no one catches it, and no one else throws it back.
 - Answer: If you throw the ball up in the air.
8. Provide the cadets with the following definition of creativity:
- Creativity is the combining of elements in a new way.
 - A new idea or product is often a combination of unlike elements previously thought to be completely unrelated.



There are two types of creativity:

- **Technical.** People create new theories, technologies or ideas; and
- **Artistic.** Involves unique methods of self-expression.

Creative people have three qualities:

- an **ability** to imagine relationships between unlike items,
- a **playful attitude** towards new ideas, and
- a **willingness** to work at changing and improving ideas and solutions.

9. Compare the definition with the ideas that the cadets brainstormed on their flip chart paper.

SAFETY

Nil.

CONFIRMATION OF TEACHING POINT 1

The cadets' participation in the activity will serve as the confirmation of this TP.

Teaching Point 2**Have the cadets participate in activities that celebrate and encourage creativity.**

Time: 10 min

Method: In-Class Activity

ACTIVITY**OBJECTIVE**

The objective of this activity is to have the cadets participate in activities that celebrate and encourage creativity.

RESOURCES

- Celebrate Success handout located at Attachment E (one per cadet),
- Flip chart paper, and
- Markers.

ACTIVITY LAYOUT

Nil.

ACTIVITY INSTRUCTIONS

1. Explain to the cadets that upon hearing the attention signal Two Snaps and a Clap, they will:
 - a. repeat the signal immediately by snapping fingers on both hands twice and clapping once;
 - b. stop, look at the instructor and wait for an announcement; and
 - c. carry on when told to do so.
2. Have the cadets practice the two snaps and a clap.
3. Distribute the Celebrate Success handout located at Attachment E to each cadet.
4. Read Attachment E together.

**STIMULATE THE BRAIN TO THINK CREATIVELY**

The right side of the brain is the creative side and the left side of the brain is the mathematical side. One side of the brain usually dominates the other with scientific people having a more dominant left side and artistic people having a more dominant right side.

Creativity can be improved by having both sides of the brain switched on and functioning. The left side of the brain controls the right side of the body and the right side of the brain controls the left side of the body. Physical activity increases oxygen flow to the brain and helps it function better.

5. Divide the cadets into four groups to represent each cheer.
6. Provide the cadets two minutes to practice each cheer.

7. Provide each group one minute each to demonstrate each cheer to the class and have them participate in their cheer after each demonstration.
8. Debrief the cadets by emphasizing the importance for motivation and physical activity in lessons.

SAFETY

Nil.

CONFIRMATION OF TEACHING POINT 2

The cadets' participation in the activity will serve as the confirmation of this TP.

Teaching Point 3

Conduct an activity where the cadets will identify the benefits of a creative lesson.

Time: 15 min

Method: In-Class Activity



Present the following information to the cadets prior to conducting the activity.

The preparation of a well-developed lesson:

- provides structure and organization;
- guides the instructor through each stage of the lesson; and
- ensures that all essential information is delivered.

A well-developed lesson does not ensure the cadet is interested and engaged in the learning process. Well-planned lessons that creatively challenge and involve the cadets in a variety of activities engage the cadets in the learning process and ensure that learning outcomes are achieved.



Ask the cadets to think about a time when they were bored during a lesson and a time when they were interested during a lesson. Have them think about the two experiences as they take part in the brainstorming activity.

ACTIVITY

Time: 10 min

OBJECTIVE

The objective of this activity is to have the cadets identify the benefits of a creative lesson.

RESOURCES

- The Benefits of Creative Lessons handout located at Attachment F
- The Benefits of Creative Lessons Worksheet located at Attachment G,

- The Benefits of Creative Lessons Answer Key located at Attachment H,
- The Benefits of Creative Lessons Phrase Strips located at Attachment I (one set per group),
- Flip chart paper,
- Markers,
- Pencils / pens, and
- Tape.

ACTIVITY LAYOUT

Nil.

ACTIVITY INSTRUCTIONS

1. Divide the cadets into groups of three or four.
2. Distribute the Benefits of Creative Lessons handout located at Attachment F to each cadet and review the handout together.
3. Distribute the Benefits of Creative Lessons worksheet located at Attachment G to each cadet.
4. Give the cadets five minutes to work together to complete the worksheet.
5. After five minutes review the answers using the Benefits of Creative Lessons Answer Key located at Attachment H.
6. Distribute the Strips located at Attachment I, flip chart paper and tape to each group.
7. Have each group divide their sheet of flip chart paper into two columns:
 - a. uncreative lesson, and
 - b. creative lesson.
8. Have each group place each strip in the appropriate column.
9. Review the cadets' posters and debrief the cadets.



All strips are located under the creative lesson column.



Many instructors do not engage cadets because they do not use enough creativity in their teaching. Some aspects of the cadet program are personally interesting to the cadets which helps compensate for this. Some lessons however, are not personally interesting to the cadets and depend more heavily on the instructors' creative ability.

SAFETY

Nil.

CONFIRMATION OF TEACHING POINT 3

The cadets' participation in the activity will serve as the confirmation of this TP.

Teaching Point 4

Conduct an activity where the cadets will identify the stages of the creative process.

Time: 20 min

Method: In-Class Activity



Present the following information to the cadets prior to conducting the activity.

THE CREATIVE PROCESS

A lesson plan is an organized outline for a single period of instruction. It is a necessary guide for instructors because it tells them:

- what to do,
- in what order to do it, and
- what method(s) to use in teaching the material.

Each time an instructor is faced with the challenge of planning a creative lesson they can apply the creative thinking process as outlined below.

ACTIVITY

Time: 15 min

OBJECTIVE

The objective of this activity is to have the cadets participate in the creative process.

RESOURCES

- The Creative Process handout located at Attachment J (one per cadet),
- Forced Analogy worksheet located at Attachment K (one per group),
- Forced Analogy Guide located at Attachment L,
- Empty match box (one per group), and
- HB # 2 pencil (one per group).

ACTIVITY LAYOUT

Nil.

ACTIVITY INSTRUCTIONS

1. Distribute the Creative Process handout located at Attachment J to each cadet.
2. Review the process with the cadets.
3. Distribute an empty matchbox and the Forced Analogy worksheet to each group.
4. Provide five minutes for the groups to compare the matchbox to their local corps. Guide the groups through this step by offering assistance as required. Encourage them to be creative in their comparison.



Circulate around the room to ensure that the cadets are processing the information. Use Attachment L as a guide to cadets experimenting difficulty.

5. Have the cadets copy their responses in the forced analogy blank template for the matchbox activity.



If groups finish early, they can continue with the second analogy.

- a. Distribute a HB # 2 pencil to each group.
- b. Have the cadets use forced analogy to compare parts of the pencil to the Canadian Cadet Organization (CCO).
- c. Have the cadets write their responses on the Forced Analogy worksheet.

6. Have each group assign one of its members to share their chart with the whole group.
7. Have the cadets work in their groups and alternately ask the questions from the Forced Analogy worksheet. Allow them to refer to The Creative Process handout located at Attachment J to help answer the questions.

SAFETY

Nil.

CONFIRMATION OF TEACHING POINT 4

The cadets' participation in the activity will serve as the confirmation of this TP.

Teaching Point 5

Conduct an activity where the cadets will incorporate creativity into the lesson-planning process.

Time: 20 min

Method: In-Class Activity



Present the following information to the cadets prior to conducting the activity.

INCORPORATE CREATIVITY INTO A LESSON PLAN

Instructors are constantly challenged to plan lessons that engage cadets in the learning process. Often the only difference between creative and uncreative instructors is self-perception. Creative instructors see themselves as creative and have the confidence to attempt new things. Uncreative instructors do not think about creativity and do not give themselves the opportunity to create anything new.



The first step towards becoming more creative is to relax. It is far more difficult to be creative when the body is tired or stressed. Creativity is found in the subconscious mind which is more accessible in a relaxed state.

To be creative during lesson planning instructors set aside time to examine if there is a better way of instructing a previously taught lesson or to play around with different ways of instructing a new lesson. This process should become a habitual part of the instructor's thinking.

Creative lessons are filled with physical and mental activities that involve all the cadets. The instructor should ensure that the cadets always feel emotionally safe in the learning environment and can take part in all learning activities without fear of being embarrassed, put down or ridiculed. Instructors can do this by:

- showing a positive attitude;
- showing interest in the lesson topic;
- treating cadets respectfully and demanding that cadets treat their peers respectfully;
- challenging cadets with fun activities that are not too easy or too difficult;
- rewarding effort as well as results;
- appealing to different learning styles;
- providing specific feedback;
- encouraging the cadets;
- communicating clear expectations and routines; and
- providing processing time.

ACTIVITY

Time: 15 min

OBJECTIVE

The objective of this activity is to have the cadets incorporate creative elements into the lesson-planning process.

RESOURCES

- Ways to Incorporate Creativity handout located at Attachment M, and
- Sample lesson plan (one per group).



The sample lesson plan can be any lesson plan that has been developed for Green or Red Star training. A sample lesson plan should be developed if none are available.

As an alternative, cadets may use the lesson plan they developed for EO M409.05 (Instruct a 30-Minute Lesson).

ACTIVITY LAYOUT

Nil.

ACTIVITY INSTRUCTIONS

1. Distribute the Ways to Incorporate Creativity handout located at Attachment M and review as a class.
2. Distribute the sample lesson plan to each group.
3. Allow each group 10 minutes to adapt a lesson plan by incorporating some of the creative elements at appropriate places throughout the lesson.
4. Circulate around the room providing assistance as required.
5. Give each group two minutes to present their ideas for their lessons to the class.

SAFETY

Nil.

CONFIRMATION OF TEACHING POINT 5

The cadets' participation in the activity will serve as the confirmation of this TP.

END OF LESSON CONFIRMATION

The cadets' participation in the lesson-planning activity will serve as the confirmation of this lesson.

CONCLUSION

HOMEWORK / READING / PRACTICE

Nil.

METHOD OF EVALUATION

Nil.

CLOSING STATEMENT

Lessons that creatively challenge and involve the cadets in a variety of activities engages them in the learning process and ensure that learning outcomes are achieved.

INSTRUCTOR NOTES / REMARKS

This EO should be scheduled as one training session.

This EO shall be conducted after EO M409.05 (Instruct a 30-Minute Lesson).

REFERENCES

- C0-375 ISBN 978-1-879097-10-0 Kagan, S., & Kagan, M. (2009). *Kagan cooperative learning*. San Clemente, CA: Kagan Publishing.
- C0-377 Canadian Yachting Association. (2002). *Level 2 technical coach manual*. Kingston, ON: Canadian Yachting Association.
- C0-381 McDonald, E. (2006). *How to involve and engage students*. Retrieved March 4, 2009, from http://www.education-world.com/a_curr/columnists/mcdonald/mcdonald007.shtml
- C0-383 Bell, A. (2007). *Creating a learning centered environment–Introduction*. Retrieved February 23, 2009, from <http://www.dialogueonlearning.tc3.edu/model/environment/Introduction-grp.htm>
- C0-385 Exalted Living. (2009). *Creativity on demand*. Retrieved March 3, 2009, from <http://www.exaltedliving.com/creativity.htm>
- C0-386 International Forum of Educational Technology & Society. (2006). *Integrating creativity into online university courses*. Retrieved February 11, 2009, from http://ifets.ieee.org/discussions/discuss_september2006.html
- C0-387 Beals, G. (1998). *Thomas Edison "Quotes"*. Retrieved March 9, 2009, from <http://www.thomasedison.com/index.html>
- C0-388 Schoenherr, N. (2007). *Being more creative in everyday life is simple, says author of 'Group Genius'*. Retrieved March 10, 2009, from <http://news-innfo.wustl.edu/tips/page/normal/9421.html>
- C0-389 Soria, R. (2009). *How to think like a genius*. Retrieved March 09, 2009, from <http://www.creativity-portal.com/howto/a/davinci/genius.html>
- C0-395 MindTools. (2009). *Approaches to creativity*. Retrieved March 16, 2009, from http://www.mindtools.com/pages/article/newCT_00.htm

MIXER

Proctor and Gamble very creatively combined Pringles potato chips and printing to produce Pringles Prints Potato Chips. Words and images are printed on one side of individual crisps in blue or red. (<http://www.junkfoodnews.net/PringlesPrints.htm>)

Combine the two elements to make a new phrase / word. The first one is done for you.

A TROLLEY AND A SUITCASE TO GET

luggage on wheels

AN IGLOO AND A HOTEL TO GET AN

A PHOTOCOPIER AND A TELEPHONE TO GET A

A BELL AND A CLOCK TO GET AN

A SURF BOARD AND A SAIL BOAT TO GET

FRENCH FRIES AND CHEESE TO GET

THIS PAGE INTENTIONALLY LEFT BLANK

PICTURE THIS...

Look at each picture and discuss how the pictures are creative.





**If you can think it,
you've just created it,
even if you can't
hold it in your hand."**

— Chris Dunmire

Figure B-1 Creative Pictures

Note. From *Creativity Portal: Nit Wits*, by C. Dunmire, 2007, Copyright (2007) by Chris Dunmire. Retrieved April 23, 2009, from <http://www.creativity-portal.com/becreative/activities>

Creativity / Writing Prompt:

List five ways the little gloved one can have its reflection, seeing all of his fingers upright. Tap into that imagination of yours and take it away!

CLICHE STRECTCHING

cliche *n* : a trite phrase or expression : trite *adj* : used so commonly that the novelty has worn off — *Merriam-Webster Dictionary*

This creativity exercise forces your brain to buzz. Skim through the list provided and identify the phrases that you find interesting. Then combine two or three cliches to form new coherent or funny phrases. Read the examples below for ideas.

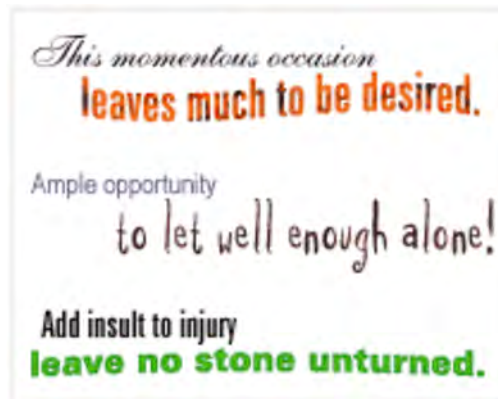

a bad scene
add insult to injury
agree to disagree
all things considered
all too soon
along these lines
ample opportunity
armed to the teeth
as a matter of fact
at a loss for words
at one fell swoop
avoid it like the plague
awaiting further orders

back at the ranch
back to the drawing board
bated breath
beginning of the end
before you know it
benefit of the doubt
best-laid plans
better late than never
better left unsaid
beyond the shadow of a doubt
bite the bullet
bitter end
bone of contention
bottom line
budding genius

leave no stone unturned
leaves much to be desired
leave up in the air
lend a helping hand
let well enough alone
line of least resistance
little woman
lit up like a Christmas tree
live and let live
lock, stock, and barrel
long arm of the law
look before you leap

marked contrast
matter of life and death
mecca for travelers
method to his madness
milk of human kindness
miraculous escape
moment of truth
momentous occasion
monumental traffic jam
moot point
more than meets the eye
more the merrier
motley crew

narrow escape
nearest and dearest

A-CR-CCP-704/PF-001
Attachment C to EO C409.04
Instructional Guide

burning question
busy as a bee
by leaps and bounds
by the same token

calm before the storm
call of the wild
casual encounter
chain reaction
charged with emotion
checkered past
cherished belief
circumstances beyond my control
clear as crystal
come full circle
contents noted
cool as a cucumber
curiously enough
cut a long story short
cut down in his prime

days are numbered
dead as a doornail
deafening crash
depths of despair
diamond in the rough
dig in your heels
do not hesitate to
drastic action
due consideration

each and every
easier said than done
eat, drink, and be merry
eminently successful
engage in conversation
epic struggle
even tenor
exception that proves the rule
existing conditions
express one's appreciation

fall on bad times
fall on deaf ears
far and wide
far be it from me
fateful day
fate worse than death
feel free to
feel vulnerable
festive occasion
few and far between

needs no introduction
never a dull moment
never before in the history of
nipped in the bud
no sooner said than done

one and the same
ongoing dialogue
on more than one occasion
open secret
order out of chaos
other things being equal
outer directed
overwhelming odds
own worst enemy

pales in comparison
paralyzed with fright
paramount importance
pay the piper
peer group
pet peeve
pick and choose
pie in the sky
pinpoint the cause
pipe dream
place in the sun
play hardball
play it by ear
poor but honest
powder keg
powers that be
pros and cons
proud heritage
proud possessor
pull one's weight

rack and ruin
ravishing beauty
red-letter day
regrettable incident
reigns supreme
reliable source
remedy the situation
right on
ripe old age
round of applause

sadder but wiser
saw the light of day
scathing sarcasm
sea of faces

final analysis
finishing touches
fit as a fiddle
food for thought
fools rush in
foregone conclusion
foul play
from the sublime to the ridiculous

generation gap
give the green light to
go down the drain
goes without saying
good team player
grave concern
green with envy
grim reaper
grind to a halt

hands across the sea
happy pair
hastily summoned
have the privilege
heartfelt thanks
heart of the matter
heart's desire
heated argument
heave a sigh of relief
herculean efforts
hook, line, and sinker
hook or crook
hope for the future
hot pursuit
hunker down

ignorance is bliss
ill-fated
immeasurably superior
in close proximity
infinite capacity
innocent bystander
in no uncertain terms
in our midst
in reference to
in short supply
in the limelight
in the nick of time
in the same boat with
in the twinkling of an eye
in this day and age
into full swing
irony of fate

seat of learning
second to none
select few
selling like hotcakes
shattering effect
shift into high gear
shot in the arm
sigh of relief
silence broken only by
silhouetted against the sky
simple life
skeleton in the closet
snug as a bug in the rug
social amenities
spectacular event
spirited debate
stick out like a sore thumb
stick to one's guns
straight and narrow path
structure one's day
such is life
superhuman effort
supreme sacrifice
sweat of his brow
sweeping changes
sweet sixteen

take the bull by the horns
telling effect
terror stricken
thanking you in advance
there's the rub
this day and age
those present
throw a monkey wrench
throw a party
throw caution to the wind
tie that binds
time of one's life
tongue in cheek
too funny for words
too numerous to mention
tough it out
tower of strength
trials and tribulations
trust implicitly

uncharted seas
unprecedented situation
untimely end
untiring efforts

irreplaceable loss
it dawned on me

keep options open

labor of love
lashed out at
last analysis
last but not least
last-ditch effort
leaps and bounds

vale of tears
vanish into thin air

watery grave
wax eloquent/poetic
weaker sex
wear and tear
whirlwind tour
wide open spaces
words fail to express
word to the wise
wrought havoc

Figure C-1 Brain Bender

Note. From *Creative Slush* by C. Dunmire, 2009, Copyright 2005–2009 by Chris Dunmire. Retrieved April 23, 2009, from <http://chrisdunmire.com/fun/mixedcliche.shtml>

MIXER ANSWER KEY

Proctor and Gamble very creatively combined Pringles potato chips and printing to produce Pringles Prints Potato Chips. Words and images are printed on one side of individual crisps in blue or red. (<http://www.junkfoodnews.net/PringlesPrints.htm>)

Combine the two elements to make a new word. The first one is done for you.

A TROLLEY AND A SUITCASE TO GET

luggage on wheels

AN IGLOO AND A HOTEL TO GET AN

ice hotel

A PHOTOCOPIER AND A TELEPHONE TO GET A

fax machine

A BELL AND A CLOCK TO GET AN

alarm clock

A SURF BOARD AND A SAIL BOAT TO GET

wind surfing

FRENCH FRIES AND CHEESE TO GET

poutine

THIS PAGE INTENTIONALLY LEFT BLANK

CELEBRATE SUCCESS

BRAIN KISS

1. Kiss the fingers on your open right hand.
2. Transfer the kiss to your brains by tapping your foreheads with the kissed hand.
3. Finish the kiss with flair by throwing the kissed hand in the air.

TRUCK DRIVER

1. Put your hands on the steering wheel of your pretend big rig.
2. Reach your left hand up and pull the cord of your air horns.
3. Let out two throaty honking roars, "honk, honk!"
4. Reach up with your right hand for your walkie talkie and speak into it, saying, "Chhhsshhh. Good job, good buddy. Chhhsshhh."

CHEESE GRATER

1. Hold an imaginary block of cheese in one hand and an imaginary grater in the other.
2. Slide the cheese against the graters five times and say, "Grate, grate, grate, grate, grate job!"

FIREWORKS

1. Push your palms together in front of your chests.
2. Raise your palms above your head, imitating a firework shooting into the sky, complete with a "whooooooooosh" sound.
3. When the firework reaches its highest point of ascent, clap your hands above your head, snap your fingers, and wiggle your facedown fingers as you slowly lower your hands.

THIS PAGE INTENTIONALLY LEFT BLANK

THE BENEFITS OF CREATIVE LESSONS

Prevent Disruptions

Many times cadets misbehave during a lesson because of boredom. When they are bored, their minds begin to wander and they start to wonder " what would happen if I ... " The cadets' attention is not focused on the lesson and soon little disruptions occur which often become big disruptions. Creative lessons focus the cadets' attention on the instructional activity and they are too busy to become disruptive.

Engage Cadets

When the instructor develops a fresh approach to a lesson, the cadets become interested in the lesson and motivated to pay attention. If the instructor conducts activities that physically and mentally involves the cadets, a transfer of power from the instructor to the cadets occurs. The cadets assume more responsibility for their own learning and the instructor becomes a guide.

Involve More Cadets

In a traditional lesson, the instructor talks more than two thirds of the time, mostly giving instructions and answering questions. Less than one third of the time is spent on individual interactions with cadets in the form of praise, encouragement, specific feedback and guiding cadets as they work with others. In creative lessons the instructor communicates less to the whole group and more with individual cadets or small groups of cadets. By using techniques, such as those described at Attachment M, the instructor can involve at least half of the cadets in an interaction at one time and all of the cadets before the lesson is over.

Bridge the Gap Between Watching (Passive) and Doing (Active)

Learning is an active social process and occurs best when the cadets participate with their peers and their instructor to experiment with new ideas and complete exercises. Creative lessons encourage cadets to actively participate by providing them with interactive opportunities, rather than simply sit and watch or listen to the instructor.

Identify Cadets' Weaknesses

Continually involving cadets in interactive activities provides an observant instructor with numerous opportunities to identify who is doing well and who is experiencing difficulty. The instructor can then intervene and make changes to immediately meet that need rather than wait for the lesson or a series of lessons on the one topic to be concluded and tested.

Encourage the Cadets to Interact With One Another

Creative learning activities actively encourage social interactions between the cadets and their peers, and the cadets and their instructors. Learning is an active social process which cadets need to practice if they are to get the most out of the Cadet Program.

Pace Learning

To pace learning is to challenge the cadets just beyond their present level of ability. If challenged too far, cadets give up but if challenged too little, they become bored. The trick is to stimulate cadets to the point of mild discomfort, forcing them to learn something new.

THIS PAGE INTENTIONALLY LEFT BLANK

BENEFITS OF CREATIVE LESSONS WORKSHEET

Prevent Disruptions

Many times cadets _____ during a lesson because of boredom. Creative lessons _____ the cadets' _____ on the _____ and they are too busy to _____.

Engage Cadets

If the instructor conducts activities that physically and mentally involve the cadets they assume more _____ for their own learning and the instructor becomes a _____.

Involve More Cadets

In a _____ lesson, the instructor talks more than _____ of the time mostly giving _____ and _____. In _____ lessons the instructor communicates _____ to the whole _____ and more with individual _____ or _____ of cadets.

Bridge the Gap Between Watching (Passive) and Doing (Active)

Creative lessons encourage cadets to _____ by providing them with _____ rather than simply _____ and _____ or _____ to the instructor.

Identify Cadets' Weaknesses

Involving cadets in interactive activities provides an observant _____ with numerous opportunities to identify who is doing _____ and who is experiencing _____. The instructor can then _____ these cadets rather than wait for the lesson to be over.

Encourage the Cadets to Interact With One Another

Creative learning activities actively encourage _____ between the cadets and their _____ and the cadets and their _____.

Pace Learning

Creative lessons challenge the cadets just _____ their present level of ability. If challenged too far, cadets _____ but if challenged too little, they become _____.

THIS PAGE INTENTIONALLY LEFT BLANK

BENEFITS OF CREATIVE LESSONS ANSWER KEY

Prevent Disruptions

Many times cadets ***misbehave*** during a lesson because of boredom. Creative lessons ***focus*** the cadets' ***attention*** on the ***lesson*** and they are too busy to ***become disruptive***.

Engage Cadets

If the instructor conducts activities that physically and mentally involve the cadets they assume more ***responsibility*** for their own learning and the instructor becomes a ***guide***.

Involve More Cadets

In a ***traditional*** lesson, the instructor talks more than ***two thirds*** of the time mostly giving ***instructions*** and ***answering questions***. In ***creative*** lessons the instructor communicates ***less*** to the whole ***group*** and more with individual ***cadets*** or ***small groups*** of cadets.

Bridge the Gap Between Watching (Passive) and Doing (Active)

Creative lessons encourage cadets to ***actively participate*** by providing them with ***interactive opportunities*** rather than simply ***sit*** and ***watch*** or ***listen*** to the instructor.

Identify Cadets' Weaknesses

Involving cadets in interactive activities provides an observant ***instructor*** with numerous opportunities to identify who is doing ***well*** and who is experiencing ***difficulty***. The instructor can then ***help*** these cadets rather than wait for the lesson to be over.

Encourage the Cadets to Interact With One Another

Creative learning activities actively encourage ***social interactions*** between the cadets and their ***peers*** and the cadets and their ***instructor***.

Pace Learning

Creative lessons challenge the cadets just ***beyond*** their present level of ability. If challenged too far, cadets ***give up*** but if challenged too little, they become ***bored***.

THIS PAGE INTENTIONALLY LEFT BLANK

BENEFITS OF CREATIVE LESSONS PHRASE STRIPS

Cut-out each strip.

PREVENT DISRUPTIONS

MORE CADETS INVOLVED

MORE DOING THAN WATCHING

IDENTIFIES CADETS' WEAKNESSES

MORE CADET INTERACTIONS

PACE LEARNING

THE CREATIVE PROCESS

| STAGE | DESCRIPTION | ACTION |
|------------------------|---|--|
| Preparation | Look at the lesson content in as many different ways as possible. Brainstorm possible creative elements to include in the lesson. Decide generally where to include creative elements in the lesson. | Use visualizations such as diagrams, charts, and webs. Individually brainstorm at first. Group brainstorm with other creative people if necessary. Take time to reflect on the lesson and mentally picture what you would like to see happen during the lesson. |
| Incubation | Collect and sort all relevant information. Continue to analyze and imagine ways to deliver the lesson. Make connections between the two like or unusual items. Prepare for the accident or eureka moment when everything falls into place. | Become an expert on the subject of the lesson. Do the homework. Combine and recombine ideas, hunches and thoughts into different combinations no matter how much they are unlike or unusual. Use the forced analogy. Use reversal. Ask "How can the lesson be made boring?" This may kick start your creativity. Use provocation by making the statement: "Lessons should not be creative". Ask "What have I done?" rather than "Why have I failed?". |
| Illumination or Eureka | Everything falls into place often when the problem is not being thought of at all. | Relax. Creativity is found in the subconscious mind which is more accessible in a relaxed state. |
| Verification | Decide if the new idea, insight, hunch or thought works. Continue testing and improving the new idea, insight, hunch or thought. | Decide if the new idea improves the lesson or is merely a gimmick. Write the lesson. Never create something to be used forever. |

THIS PAGE INTENTIONALLY LEFT BLANK

FORCED ANALOGY

FORCED ANALOGY—MATCHBOX

| MATCHBOX | LOCAL CORPS |
|----------------------------------|-------------|
| Striking surface on two sides | |
| Two Parts | |
| Sliding Centre | |
| Cardboard | |
| Decorated with print and colours | |
| Contains Matches | |

FORCED ANALOGY—PENCIL

| PENCIL | ASPECT OF THE CANADIAN CADET ORGANIZATIONS (CCO) SYMBOLIZED |
|---------------|---|
| Silver Ring | |
| Yellow Colour | |
| Six Sides | |
| Flat Sides | |
| Eraser | |
| Wood Shaft | |
| Lead | |
| Write | |
| Inexpensive | |

FORCED ANALOGY

QUESTIONS:

1. What is the first stage of the creative process?
2. What is one technique which can be used in the incubation stage to make a connection between unlike elements?
3. What happens during the illumination or eureka stage?
4. What happens during the verification stage?

FORCED ANALOGY GUIDE

The following is a list of possible answers. Use these answers to help guide cadets if they are having difficulty with the activity.

FORCED ANALOGY—MATCHBOX

| MATCHBOX | LOCAL CORPS |
|----------------------------------|-------------------------------------|
| Striking surface on two sides | Flexibility |
| Two Parts | Officers and Cadets |
| Sliding Centre | More than one way to do things |
| Cardboard | Easily broken / can not be careless |
| Decorated with print and colours | Lots of fun activities |
| Contains Matches | Danger—always practice safety |

FORCED ANALOGY—PENCIL

| PENCIL | ASPECT OF THE CANADIAN CADET ORGANIZATIONS (CCO) SYMBOLIZED |
|--------------|---|
| Silver Ring | Cadets receive medals and awards |
| Yellow Color | At Cadet Summer Training Centres different companies are identified by different colors |
| Six Sides | Cadet leaders have to remember to do many things |
| Flat Sides | Some aspects of cadet life are traditional |
| Eraser | Some cadets / officers / aspects of cadet life should be changed |
| Wood Shaft | Customs and traditions |
| Lead | Cadets can be challenging—get the lead out |
| Write | Cadets write lessons, orders, logbooks, attendance rolls, etc. |
| Inexpensive | The CCO offers many opportunities at little cost |

FORCED ANALOGY—PENCIL (alternate)

| PENCIL | ASPECT OF THE CANADIAN CADET ORGANIZATIONS (CCO) SYMBOLIZED |
|---------------|---|
| Silver Ring | Highest Rank |
| Yellow Colour | Value excellence |
| Six Sides | Different types of training |
| Flat Sides | Things will not always run smoothly—pencil does not roll smoothly |
| Eraser | Colour represents the poppy |
| Wood Shaft | The Cadet Program is structured |
| Lead | In the centre of the pencil representing the aims of the CCO |
| Write | Good experience to put on a resume |
| Inexpensive | Can not always do things because of lack of money |

QUESTIONS:

- Q1. What is the first stage of the creative process?
- Q2. What is one technique which can be used in the incubation stage to make a connection between unlike elements?
- Q3. What happens during the illumination or eureka stage?
- Q4. What happens during the verification stage?

ANTICIPATED ANSWERS:

- A1. The first stage is the preparation stage.
- A2. The forced analogy, reversal and provocation techniques can be used in the incubation stage.
- A3. An answer falls into place often unexpectedly.
- A4. In the verification stage the instructor must decide if the new idea improves the lesson or is merely a gimmick, write the lesson and continually update the lesson.

WAYS TO INCORPORATE CREATIVITY

INTRODUCTION—USE ATTENTION-GETTING DEVICES

In the introduction, the instructor should capture the cadets' interest and motivate them to learn by using attention-getting devices, such as:

- an interesting fact related to the lesson topic that shocks, surprises or arouses curiosity;
- an unusual statistic related to the lesson topic;
- a personal anecdote related to the topic;
- a rhetorical question—the instructor does not want or expect the cadets to answer;
- an overt-response question—the instructor does want or expect the cadets to answer;
- an interesting quotation by a famous person;
- a visual demonstration such as an object, picture or some other representation that relates to the topic; and
- an explanation of how the topic is relevant to the cadets' lives or in their best interest.

BODY—USE INFORMATION-PROCESSING TECHNIQUES

Rally robin. In pairs, cadets alternate generating oral responses.

Round robin. In teams, students take turns responding orally.

Pairs check. One partner solves a problem while the other coaches. Then they switch roles. After every two problems, pairs check their answers with another pair and celebrate.

Rally coach. Partners take turns, one solving a problem while the other coaches.

Timed pair share. In pairs, cadets share with a partner for a predetermined time while the partner listens. Then partners switch roles.

CONFIRMATION—ACTIVITIES

Jigsaw worksheets. Instead of having cadets complete a worksheet individually, break them into small groups and assign a portion of the worksheet to each group. Each group must complete its assigned portion of the worksheet and use a poster or some other presentation aid to present the information to the whole group.

Graphics. Have the cadets create graphic organizers such as webs or mobiles to summarize information.

Creative writing. Have the cadets create rhymes, poems or songs to summarize information. If teaching terminology, symbols or similar information, have the cadets write a fairy tale or children's story using the information.

Create a chart. Type chronological information using a large font and cut it up into strips. Organize the cadets into pairs or small groups and give each pair or group an envelope with the strips of information and have them work together to place the information in the correct order and paste it on a sheet of chart paper. Time the activity for fun.

Information chain. Have each cadet write one fact that they have learned during the class on a piece of coloured paper, if possible. Have the class line up in front of the room and invite the first cadet to read their slip then fold it into a link and staple it. Invite the next student to read a fact and attach it to the chain and continue in this fashion until all cadets have created a link.

Scavenger hunt. Teach identification lessons by planting clues around the room and having cadets engage in a scavenger hunt. The clues may be actual items or pictures of items. When cadets find an actual item or some representation of it, they must describe the item to the group.

Road trip. Create a road trip. Place stop signs around the room containing information describing what the cadet must do. The cadets travel to each place, complete the activity and have their passport stamped.

CONCLUSION

Read the closing statement directly from the lesson plan. Re-motivate the cadets by referring back to the introduction and stress how the material is relevant to their personal lives or in their best interest.

Finish in a dramatic manner with an attention-getting device such as that used to introduce the lesson.



**COMMON TRAINING
GOLD STAR
INSTRUCTIONAL GUIDE**



SECTION 10

EO C409.05 – ACT AS AN ASSISTANT DRILL INSTRUCTOR

Total Time:

90 min

PREPARATION

PRE-LESSON INSTRUCTIONS

Resources needed for the delivery of this lesson are listed in the lesson specification located in A-CR-CCP-704/PG-001, *Gold Star Qualification Standard and Plan*, Chapter 4. Specific uses for said resources are identified throughout the instructional guide within the TP for which they are required.

Review the lesson content and become familiar with the material prior to delivering the lesson.

PRE-LESSON ASSIGNMENT

The course officer shall communicate with the training officer to ensure that cadets are paired with a Green, Red or Silver Star drill instructor during a regular training session. As part of the training session, the instructor and cadet should be scheduled for two periods of instruction. The time the cadet is not instructing may be used for lesson preparation, briefing, debriefing, securing training aids, etc.

A number of factors may exist based on the size of the corps that will not allow for all Gold Star cadets to be scheduled for this EO at the same time. In this circumstance, special consideration should be given to minimize the cadet's absence from other areas of training. For example, scheduling half of the cadets for this EO while the other half is scheduled for EO C422.03 (Discuss Map Software) and reversing the schedule for the following training session.

APPROACH

OJT was chosen for this lesson as it allows the cadet to assist instructing a drill lesson in a safe and controlled environment. The OJT experience provides the cadet a practical application of learned skills in a realistic setting. The cadet reflects on the experience and receives feedback on the performance, which helps to shape future experiences. The cadet develops a sense of responsibility from the OJT aiding their development as a leader.

INTRODUCTION

REVIEW

Nil.

OBJECTIVES

By the end of this lesson the cadet shall have acted as an assistant drill instructor.

IMPORTANCE

It is important for cadets to act as an assistant drill instructor as it gives them the opportunity to practice, observe and assist in performing the duties of a drill instructor in a safe and controlled environment during a regular training session.

Teaching Point 1**Have the cadets act as assistant drill instructors in on-the-job training (OJT).**

Time: 90 min

Method: On-The-Job Training

PURPOSE

The purpose of having the cadets act as assistant drill instructors is to provide them with an authentic experience that allows them to observe and assist in performing the duties of a drill instructor during a regular training session. This activity is intended to be experiential in nature, providing the cadets the opportunity to work with experienced instructors, with assessment for learning being the focus rather than assessment of learning. When pairing the cadets with an instructor, consideration must be given to such things as the background, specialty and confidence of each cadet while in front of a class. The proper pairing of cadets with an instructor will help to ensure the OJT experience satisfies the stated purpose.

GENERAL INSTRUCTIONS

For one training session the cadets shall be paired with an instructor who is instructing a group of cadets participating in PO 108 (Participate in an Annual Ceremonial Review Parade), PO 208 (Execute Drill as a Member of a Squad) or PO 308 (Direct a Squad Prior to a Parade).

The instructor is responsible for the following:

1. Ensure the cadet is briefed on their responsibilities and tasks prior to the commencement of the lesson.
2. Ensure the cadet is provided opportunities to perform some or all tasks normally completed by the instructor, such as:
 - a. **Preparing training aids as required.** The cadet may be asked to gather and prepare training aids.



The focus of this EO should be the development of instructional skills and increasing experience and confidence while in front of a class. The instructor should develop training aids for the lesson. Give the cadet tasks such as setting up presentation aids and organizing training aids, eg, signing out rifles for a rifle drill lesson.

- b. **Helping instruct the lesson.** The cadet may be asked to provide a demonstration or instruct a TP of a lesson.
 - c. **Supervising the cadets.** The cadet may be asked to assist with the supervision of the cadets.
 - d. **Providing assistance as required.** The cadet may be asked to provide assistance or assist with skill development by coaching or demonstrating a skill being taught.
 - e. **Securing training aids as required.** Once the lesson is complete, the cadet may be asked to secure and return training aids to storage.
3. If necessary, debrief the (Green, Red or Silver Star) cadets, correcting any content errors or omissions made by the cadet.
4. Debrief the cadet upon completion of the training session and provide them the opportunity to ask questions and seek additional feedback.

CONFIRMATION OF TEACHING POINT 1

The cadets' acting as an assistant drill instructor will serve as the confirmation of this TP.

END OF LESSON CONFIRMATION

The cadets' acting as an assistant drill instructor will serve as the confirmation of this lesson.

CONCLUSION

HOMEWORK / READING / PRACTICE

Nil.

METHOD OF EVALUATION

Nil.

CLOSING STATEMENT

Acting as an assistant drill instructor allows for the development of skills necessary to become a competent drill instructor by observing, practicing instruction and receiving feedback from an experienced drill instructor in a safe and controlled environment during a regular training session.

INSTRUCTOR NOTES / REMARKS

Prior to this EO, the course officer shall communicate with the training officer to ensure that cadets are paired with a Green, Red or Silver Star drill instructor for a regular training session.

A number of factors may exist based on the size of the corps that will not allow for all Gold Star cadets to be scheduled for this EO at the same time. In this circumstance, special consideration should be given to minimize the cadet's absence from other areas of training. For example, scheduling half of the cadets for this EO while the other half is scheduled for EO C422.03 (Discuss Map Software) and reversing the schedule for the following training session.

During this EO the instructor shall:

1. brief the cadet prior to commencing the lesson;
2. assign the cadet tasks, to include:
 - a. preparing training aids as required;
 - b. helping instruct the lesson;
 - c. supervising the cadets;
 - d. providing assistance as required; and
 - e. securing training aids as required;
3. monitor the cadet; and
4. debrief the cadet at the end of the lesson.

REFERENCES

Nil.

THIS PAGE INTENTIONALLY LEFT BLANK



**COMMON TRAINING
GOLD STAR
INSTRUCTIONAL GUIDE**



SECTION 11

EO C409.06 – INSTRUCT A 30-MINUTE DRILL LESSON

Total Time:

90 min

PREPARATION

PRE-LESSON INSTRUCTIONS

Resources needed for the delivery of this lesson are listed in the lesson specification located in A-CR-CCP-704/PG-001, *Gold Star Qualification Standard and Plan*, Chapter 4. Specific uses for said resources are identified throughout the instructional guide within the TP for which they are required.

Review the lesson content and become familiar with the material prior to delivering the lesson.

The course officer shall communicate with the training officer to:

1. place the Gold Star cadets into the Green and Red Star drill instructor schedules;
2. ensure the cadets are assigned a 30-minute lesson at least one week prior to conducting this assessment, to include:
 - a. a lesson specification, and
 - b. an instructional guide; and
3. assign an assessor to each lesson.

Ensure that all resources requested by the cadets are available.

Photocopy the Drill Instructional Techniques Assessment Form located at Attachment A for each cadet.

PRE-LESSON ASSIGNMENT

Nil.

APPROACH

A practical activity was chosen for this lesson as it is an interactive way for cadets to develop drill instructional skills in a safe and controlled environment.

INTRODUCTION

REVIEW

Nil.

OBJECTIVES

By the end of this lesson the cadet shall have instructed a 30-minute drill lesson using a written lesson plan and the drill instruction sequence.

IMPORTANCE

It is important for cadets to instruct a 30-minute drill lesson as it gives them the opportunity to practice drill instructional skills in a practical setting and to receive feedback to further develop instructional skills and confidence.

Teaching Point 1**Supervise while the cadets instruct a 30-minute lesson.**

Time: 85 min

Method: Practical Activity

ACTIVITY**OBJECTIVE**

The objective of this activity is to have the cadets instruct a 30-minute drill lesson using a written lesson plan and the drill instruction sequence.

RESOURCES

Drill Instructional Techniques Assessment Form.

ACTIVITY LAYOUT

Nil.

ACTIVITY INSTRUCTIONS

1. Have each cadet, prior to the start of this lesson:
 - a. research lesson content;
 - b. plan a lesson;
 - c. develop instructional aids (as required); and
 - d. set up the lesson location (as required).
2. During the time allotted for this lesson, have each cadet:
 - a. provide a copy of their written lesson plan to the assessor;
 - b. instruct a 30-minute drill lesson by:
 - (1) introducing the lesson;
 - (2) presenting the content of the lesson;
 - (3) applying the drill instruction sequence;
 - (4) confirming the skills learned during the lesson; and
 - (5) concluding the lesson; and
 - c. participate in a individual feedback session with the assessor upon completion of the lesson.



The Drill Instructional Techniques Assessment Form located at Attachment A is used to provide feedback on the cadet's lesson. The form is intended solely for the purposes of assessment for learning, providing the cadets with the feedback they need to improve their own skills.

3. Once all cadets have instructed a 30-minute drill lesson, debrief the (Gold Star) cadets by providing feedback, focusing on:
 - a. best practices,
 - b. general trends and key areas for improvement, and
 - c. re-motivation, highlighting the effort and accomplishments of the group.

SAFETY

Nil.

CONFIRMATION OF TEACHING POINT 1

The cadets' participation in the activity will serve as the confirmation of this TP.

END OF LESSON CONFIRMATION

The cadet's instructing a 30-minute drill lesson will serve as the confirmation of this lesson.

CONCLUSION

HOMEWORK / READING / PRACTICE

Nil.

METHOD OF EVALUATION

Nil.

CLOSING STATEMENT

Practicing drill instruction allows for the development of fundamental skills necessary to become a drill instructor while further developing confidence and providing a sense of accomplishment.

INSTRUCTOR NOTES / REMARKS

This EO shall be conducted after C309.04 (Identify Formations for Drill Instruction), EO C309.05 (Plan a Drill Lesson) and EO C309.06 (Instruct a 15-Minute Drill Lesson).

The cadets shall instruct Green or Red Star cadets on a regular training session.

The course officer shall communicate with the training officer to:

1. place the Gold Star cadets into the instructor schedule; and
2. ensure the cadets are assigned a lesson at least one week prior to conducting this EO, to include:
 - a. a lesson specification, and
 - b. an instructional guide.

Time for lesson planning for this EO is available in EO C309.05 (Plan a Drill Lesson), should the course officer deem it necessary.

Adjust the period allocation for this EO if all three periods are not required for each Gold Star cadet to instruct a 30-minute drill lesson.

REFERENCES

A0-002 A-PD-201-000/PT-000 Director History and Heritage 3-2. (2005). *The Canadian Forces manual of drill and ceremonial*. Ottawa, ON: Department of National Defence.

THIS PAGE INTENTIONALLY LEFT BLANK

**DRILL INSTRUCTIONAL TECHNIQUE
 ASSESSMENT FORM**

Cadet's Name: _____

Division: _____

Lesson Topic: _____

| CRITERIA | COMMENTS | Incomplete | Completed With Difficulty | Completed Without Difficulty |
|--|----------|------------|---------------------------------|------------------------------------|
| PREPARATION | | | | |
| Maintained dress and deportment. | | | | |
| Selected an appropriate squad formation. | | | | |
| Used a lesson plan. | | | | |
| Reviewed previous lesson. | | | | |
| INTRODUCTION | | | | |
| Stated what the cadets will learn. | | | | |
| Stated why it is important. | | | | |
| Stated where / when this skill will be applied. | | | | |
| BODY | | | | |
| Demonstrated complete movement, calling the time. | | | | |
| Demonstrated and explained the first part of the movement. | | | | |
| Had the squad practice the first part of the movement collectively, individually and collectively again. | | | | |
| Taught the second part of the movement and each subsequent part in the same manner. | | | | |
| Gave two complete demonstrations. | | | | |

| CRITERIA | COMMENTS | Incomplete | Completed With Difficulty | Completed Without Difficulty |
|--|----------|------------|---------------------------------|------------------------------------|
| Practiced the complete movement with: <ul style="list-style-type: none"> • the instructor calling the time, • the cadets calling the time, and • the cadets judging the time. | | | | |
| Used clear words of command and correct pauses. | | | | |
| Gave appropriate and immediate feedback. | | | | |
| Allowed questions after each movement. | | | | |
| END OF LESSON CONFIRMATION | | | | |
| Demonstrated the movement taught. | | | | |
| Confirmation was conducted as a squad. | | | | |
| Emphasized aspects of the movement with which the cadets experienced difficulty. | | | | |
| CONCLUSION | | | | |
| Summarized the lesson. | | | | |
| Re-motivated the cadets. | | | | |
| FEEDBACK | | | | |

 ASSESSOR'S SIGNATURE

 DATE

 CADET'S SIGNATURE



**COMMON TRAINING
ALL TRAINING LEVELS
INSTRUCTIONAL GUIDE**



CANADIAN ARMED FORCES (CAF) FAMILIARIZATION

SECTION 1

PO X20 – PARTICIPATE IN CAF FAMILIARIZATION

Total Time:

For the following EOs, refer to the lesson specifications located in A-CR-CCP-701/PG-001, *Royal Canadian Army Cadets Green Star Qualification Standard and Plan*:

- MX20.01A – Participate in a CAF Activity,
- MX20.01B – Participate in a CAF Familiarization Tour,
- MX20.01E – Attend a CAF Presentation,
- MX20.01F – Attend a CAF Commemorative Ceremony, and
- CX20.01 – Participate in CAF Familiarization Activities.

For the following EOs, refer to the instructional guides located in A-CR-CCP-701/PF-001, *Royal Canadian Army Cadets Green Star Instructional Guides*:

- MX20.01C – Fire the C7 Rifle,
- MX20.01D – Participate in a Mess Dinner,
- MX20.01G – Participate in CAF Familiarization Video Activities, and
- MX20.01H – Participate in CAF Familiarization Learning Stations.

THIS PAGE INTENTIONALLY LEFT BLANK



ROYAL CANADIAN ARMY CADETS

GOLD STAR

INSTRUCTIONAL GUIDE



SECTION 1

EO M422.01 – REVIEW SILVER STAR NAVIGATION

Total Time:

60 min

PREPARATION

PRE-LESSON INSTRUCTIONS

Resources needed for the delivery of this lesson are listed in the lesson specification located in A-CR-CCP-704/PG-001, *Gold Star Qualification Standard and Plan*, Chapter 4. Specific uses for said resources are identified throughout the instructional guide within the TP for which they are required.

Review the lesson content and become familiar with the material prior to delivering the lesson.

Learning stations are a form of group work, where the cadets learn by sorting through the information presented. When setting up learning stations, ensure there is enough room for each cadet to be comfortable and adequate space for writing down information. When the cadets arrive at a learning station, all required information shall already be available. These stations should be placed close enough together to minimize time for movement and far enough apart to avoid interruptions from other groups. For this lesson, set up three learning stations for reviewing navigation.

Instructors assigned to a learning station shall review their station's questions and locate and record their answers on the sheet provided prior to the cadets' arrival.

Photocopy the Silver Star Navigation Review worksheet located at Attachment A for each cadet.

Make three copies of the Silver Star Navigation Review Worksheet Answer Key located at Attachment B for each learning station instructor. Determine answers for Stations 2 and 3.

Photocopy the Learning Station Information Sheets located at Attachments C, D, and E for each learning station instructor.

Review Attachment A and complete a preliminary run-through of the provided questions for each station.

Review the activities, ensuring they are best suited to the training area, size of the group, staff and training aids available.

Prepare all resources necessary for the selected activities.

Assistant instructors are required at each learning station.

PRE-LESSON ASSIGNMENT

Nil.

APPROACH

A practical activity was chosen for this lesson as it is an interactive way for the cadet to develop navigation skills and knowledge in a safe and controlled environment. This activity contributes to the development of navigational skills and knowledge in a fun and challenging setting.

INTRODUCTION

REVIEW

Nil.

OBJECTIVES

By the end of this lesson the cadet shall have reviewed Silver Star navigation.

IMPORTANCE

It is important for cadets to review Silver Star navigation as it is the foundation for global positioning system (GPS) training. Silver Star navigation introduces cadets to the fundamentals of using a GPS receiver. Cadets should take every opportunity to practice and refine these skills.

Teaching Point 1**Conduct a Silver Star navigation review activity using learning stations.**

Time: 50 min

Method: Practical Activity

ACTIVITY**OBJECTIVE**

The objective of this activity is to have the cadet review Silver Star navigation.

RESOURCES

- Three GPS receivers,
- Two topographical maps of the local area,
- Nine pencils,
- One pencil eraser,
- Three copies of the Silver Star Navigation Review Worksheet Answer Key located at Attachment B,
- Three copies of the Learning Station Information Sheets located at Attachments C–E,
- One copy of the Silver Star Navigation Review Worksheet located at Attachment A for each cadet, and
- Paper.

ACTIVITY LAYOUT

Set up three learning stations as follows:

- Station 1:
 - one GPS receiver,
 - three pencils,
 - one copy of the Silver Star Navigation Review Worksheet Answer Key, and
 - one copy of the Learning Station 1 Information Sheet;
- Station 2:
 - one GPS receiver,
 - one topographical map of the local area,
 - three pencils,
 - one copy of the Silver Star Navigation Review Worksheet Answer Key,
 - one copy of the Learning Station 2 Information Sheet; and

- Station 3:
 - one GPS receiver,
 - one topographical map of the local area,
 - three pencils,
 - one pencil eraser,
 - one copy of the Silver Star Navigation Review Worksheet Answer Key, and
 - one copy of the Learning Station 3 Information Sheet.

ACTIVITY INSTRUCTIONS

1. Explain to the cadets they will be taking part in a round robin activity with stations. At each station they will be presented with the questions found on their worksheets. Inform the cadets that the activity is to be completed individually.
2. Divide the cadets into three groups, and place each group at one of the learning stations.
3. Provide each cadet a copy of the Silver Star Navigation Review Worksheet located at Attachment A to complete as they rotate through the stations.
4. Assign an assistant instructor to each learning station. Give each assistant instructor a copy of:
 - a. the Silver Star Navigation Review Worksheet Answer Key; and
 - b. the Learning Station Information Sheet to assist the cadets in completing their worksheets if required.
5. Have the assistant instructor at each station explain the worksheet and what to do.
6. Allow the cadet(s) approximately fifteen minutes to complete the station.
7. Have the cadets explain their answers individually to the instructors.
8. The instructor will confirm the answers are correct by referring to the Silver Star Navigation Worksheet (as required) and correct any errors.
9. Allow one minute for the cadets to move between stations.
10. Have the cadets complete each station, following Steps 5–8.
11. Debrief the cadets at the end of the activity. Discuss any areas of concern and answer any questions.

Station 1: Components of the GPS. At this station, the cadet shall complete the following on the worksheet for Station 1:

1. identify and briefly explain the components of the GPS, to include:
 - satellites,
 - ground stations, and
 - receivers;

2. identify the features of a GPS receiver, to include the following components:
 - antenna,
 - screen,
 - battery compartment, and
 - buttons; and
3. independently navigate through the GPS receiver and locate one of the following:
 - satellite status,
 - menu,
 - position,
 - compass navigation,
 - map, and
 - map screen.

Station 2: Set a map datum on a GPS receiver. At this station, the cadet shall complete the following on the worksheet for Station 2:

1. complete the process for confirming correct coordinate system by:
 - identifying military grid reference system (MGRS) grid system on a topographical map;
 - locating the grid zone designator; and
 - confirming the 100 000-m square identifier;
2. locate the map datum from a topographical map; and
3. set the map datum on a GPS receiver.

Station 3: Identify location using a GPS receiver. At this station, the cadet shall complete the following on the worksheet for Station 3:

1. confirm that the correct coordinate system is set on the GPS receiver;
2. locate the geographical position screen in the GPS receiver;
3. read the grid reference (GR); and
4. plot the eight-figure GR on the topographical map.

SAFETY

Nil.

CONFIRMATION OF TEACHING POINT 1

The cadets' participation in the activity will serve as the confirmation of this TP.

END OF LESSON CONFIRMATION

The cadets' participation in the learning stations will serve as the confirmation of this lesson.

CONCLUSION

HOMEWORK / READING / PRACTICE

Nil.

METHOD OF EVALUATION

Nil.

CLOSING STATEMENT

Concepts of Silver Star navigation should be understood before more challenging skills can be introduced at the Gold Star level. Throughout expeditions, there will be requirements to navigate routes. Take every opportunity to practice, whether it is plotting position on a map from a GPS grid reference or helping a junior cadet understand how a GPS receiver works.

INSTRUCTOR NOTES / REMARKS

The navigation activity will consist of three learning stations. The cadets will rotate through the stations every 15 minutes. There will be 5 minutes provided at the end of the lesson to answer questions or provide additional instruction on areas where cadets experienced difficulty.

This EO shall be conducted during the bivouac field training exercise.

Assistant instructors are required for this lesson, at each learning station.

Topographical maps have not been provided, so the cadet can use local area topographical maps.

REFERENCES

A2-036 A-CR-CCP-121/PT-001 Director Cadets 3. (2003). *Royal Canadian Army Cadet reference book*. Ottawa, ON: Department of National Defence.

C2-142 ISBN 0-7645-6933-3 McNamara, J. (2004). *GPS for dummies*. Hoboken, NJ: Wiley Publishing, Inc.

C2-143 ISBN 1-58923-145-7 Featherstone, S. (2004). *Outdoor guide to using your GPS*. Chanhassen, MN: Creative Publishing International, Inc.

C2-144 ISBN 0-07-223171-8 Broida, R. (2004). *How to do everything with your GPS*. Emerville, CA: McGraw-Hill.

SILVER STAR NAVIGATION REVIEW WORKSHEET

Cadet's Name: _____

Note: Use the back of the worksheet or an attached piece of paper(s) for additional notes / calculations if required.

| Station 1: Components of the GPS | |
|--|--|
| <p>Describe how satellites, ground stations, and receivers work.</p> <p>Select the correct statement. Identify the error(s) in the incorrect statements.</p> | <p style="text-align: center;">Select the correct statement</p> <ol style="list-style-type: none"> 1. The minimum number of satellites that are required to cover the entire Earth is 18. 2. The ground control segment of the GPS is comprised of seven ground stations that track the satellites, monitor their condition and make any necessary adjustments to keep the system accurate. 3. GPS receivers make up the user segment. It is the GPS receiver, whether it is in an airplane, a truck, a boat or in a hiker's hand, that detects the radio signals from the satellite ground stations and calculates the receiver's position. |
| <p>Identify the components of a GPS receiver.</p> | <p style="text-align: center;">Components of a GPS receiver</p> <ol style="list-style-type: none"> 1. 2. 3. 4. |
| <p>Identify and briefly explain the functions of 5 buttons on the GPS receiver.</p> | <p style="text-align: center;">Buttons on a GPS receiver</p> <ol style="list-style-type: none"> 1. 2. 3. 4. 5. |
| <p>Navigate through the GPS receiver and locate the selected screen screens determined by the instructor.</p> <p>List the screens identified.</p> | <p style="text-align: center;">Screens identified</p> <ol style="list-style-type: none"> 1. |

| Station 2: Set a map datum on a GPS receiver | |
|--|--|
| Given a topographical map of the local area and a GPS receiver, complete the process for confirming correct Military Grid Reference System (MGRS) coordinates. | Process for confirming correct MGRS 1. 2. 3. |
| Locate the map datum from a topographical map. | Map Datum |
| Set the map datum on a GPS receiver. | Set Datum |

| Station 3: Identify location using a GPS receiver | |
|---|--|
| Confirm that the correct coordinate system is set on the GPS receiver. What coordinate system is used? | Confirm correct coordinate system |
| Locate geographical position screen in a GPS receiver. | Locate geographical position screen in a GPS receiver |
| Read the GR from the GPS. | Record the GR |
| Plot the GR on the topographical map. | Plot GR |

THIS PAGE INTENTIONALLY LEFT BLANK

SILVER STAR NAVIGATION REVIEW WORKSHEET ANSWER KEY

Note: Learning stations require preparation of answers. Learning station information sheets have been provided with a detailed description on how each question should be answered.

| Station 1: Components of the GPS | | | | | | | | | | | |
|--|---|----------------------------|------------------------------|---------------------|---------------|--------------------|----------------------|------------------|--------------------------|-------------------|--|
| <p>Describe how satellites, ground stations, and receivers work.</p> <p>Select the correct statement. Identify the error(s) in the incorrect statements.</p> | <p style="text-align: center;">Select the correct statement</p> <ol style="list-style-type: none"> 1. The minimum number of satellites that are required to cover the entire Earth is 18. 2. The ground control segment of the GPS is comprised of FIVE ground stations that track the satellites, monitor their condition and make any necessary adjustments to keep the system accurate. 3. GPS receivers make up the user segment. It is the GPS receiver, whether it is in an airplane, a truck, a boat or in a hiker's hand, that detects the radio signals from the SATELLITES and calculates the receiver's position. | | | | | | | | | | |
| <p>Identify the components of a GPS receiver.</p> | <p style="text-align: center;">Components of a GPS receiver</p> <ol style="list-style-type: none"> 1. Antenna 2. Screen 3. Battery Compartment 4. Buttons | | | | | | | | | | |
| <p>Identify and briefly explain the function of 5 buttons on the GPS receiver.</p> | <p style="text-align: center;">Buttons on a GPS receiver</p> <table style="width: 100%; border: none;"> <tr> <td style="width: 50%;">1. On / Off</td> <td style="width: 50%;">6. Menu</td> </tr> <tr> <td>2. Backlight</td> <td>7. NAV</td> </tr> <tr> <td>3. Enter</td> <td>8. Mark</td> </tr> <tr> <td>4. Escape</td> <td>9. Arrow Joystick</td> </tr> <tr> <td>5. Zoom in</td> <td></td> </tr> </table> | 1. On / Off | 6. Menu | 2. Backlight | 7. NAV | 3. Enter | 8. Mark | 4. Escape | 9. Arrow Joystick | 5. Zoom in | |
| 1. On / Off | 6. Menu | | | | | | | | | | |
| 2. Backlight | 7. NAV | | | | | | | | | | |
| 3. Enter | 8. Mark | | | | | | | | | | |
| 4. Escape | 9. Arrow Joystick | | | | | | | | | | |
| 5. Zoom in | | | | | | | | | | | |
| <p>Navigate through the GPS receiver and locate the selected screen screens determined by the instructor.</p> <p>List the screens identified.</p> | <p style="text-align: center;">Screens identified</p> <table style="width: 100%; border: none;"> <tr> <td style="width: 50%;">1. Satellite screen</td> <td style="width: 50%;">4. Compass navigation</td> </tr> <tr> <td>2. Menu</td> <td>5. Map</td> </tr> <tr> <td>3. Position</td> <td>6. Map screen</td> </tr> </table> | 1. Satellite screen | 4. Compass navigation | 2. Menu | 5. Map | 3. Position | 6. Map screen | | | | |
| 1. Satellite screen | 4. Compass navigation | | | | | | | | | | |
| 2. Menu | 5. Map | | | | | | | | | | |
| 3. Position | 6. Map screen | | | | | | | | | | |

| Station 2: Set a map datum on a GPS receiver | |
|--|--|
| <p>Given a topographical map of the local area and a GPS receiver, complete the process for confirming correct MGRS coordinate system.</p> | <p style="text-align: center;">Process for confirming correct MGRS coordinate system</p> <p>The learning station instructor shall reference the local topographical map and complete the following questions prior to the cadets' arrival:</p> <ol style="list-style-type: none"> 1. Identify MGRS grid system on a topographical map. Answer: _____ 2. Locate the grid zone designator. Answer: _____ 3. Confirm the 100 000-m square identifier. Answer: _____ |
| <p>Locate the map datum from a topographical map.</p> | <p style="text-align: center;">Map Datum</p> <p>The learning station instructor shall refer to the local topographical map and find the correct datum.</p> <p>MAP Datum: _____</p> |
| <p>Set the map datum on a GPS receiver.</p> | <p style="text-align: center;">Set Datum</p> <p>Consult the GPS Receiver User Manual and Learning Station 2 Information Sheet for the detailed instructions on how to set the datum on a GPS receiver.</p> <p>Datum to be set: _____</p> |

| Station 3: Identify location using a GPS receiver | |
|--|---|
| <p>Confirm that the correct coordinate system is set on the GPS receiver.</p> <p>What coordinate system is used?</p> | <p style="text-align: center;">Confirm correct coordinate system</p> <p>Confirm that the cadet follows the process and ensures the correct coordinate system is set.</p> <p>MGRS coordinate system should be used.</p> |
| <p>Locate geographical position screen in a GPS receiver.</p> | <p style="text-align: center;">Locate geographical position screen in a GPS receiver</p> |
| <p>Read the GR from the GPS.</p> | <p style="text-align: center;">Record the GR</p> |
| <p>Plot the GR on the topographical map.</p> | <p style="text-align: center;">Plot GR</p> |

THIS PAGE INTENTIONALLY LEFT BLANK

LEARNING STATION 1 INFORMATION SHEET

HOW THE GPS WORKS

The system is divided into three parts or segments: space, ground control and users. The space segment consists of 24 satellites that orbit 20 200 km above the Earth and send radio signals toward Earth. The radio signals broadcast the position of each satellite in the sky with an electronic code.

Each satellite performs a relatively simple primary task: it transmits a timing signal using its built-in atomic clock. When a device on the ground receives that signal, it can determine its distance from the satellite.

That single measurement alone does not accomplish much, but when a GPS receiver collects timing signals from three different satellites, the receiver can determine two precise coordinates: latitude and longitude. With four satellite signals, the GPS receiver is able to determine altitude as well.

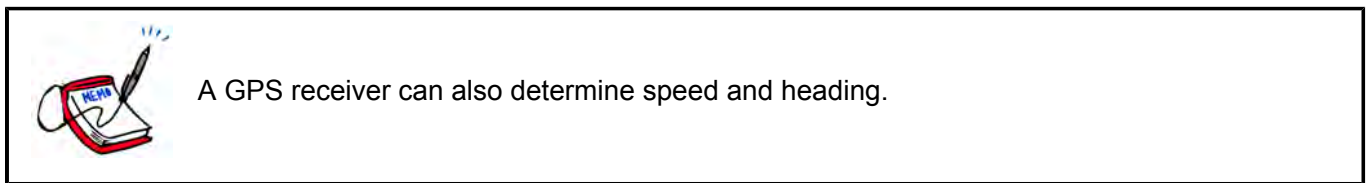

COMPONENTS OF THE GPS

Satellites

The GPS and its satellites have the following characteristics:

- The minimum number of satellites that are required to cover the entire Earth is 18, however the number of satellites in orbit fluctuates between 24 and 29 satellites due to spares and upgrading.
- Satellites orbit in a semi-synchronous orbit (orbits are coordinated, but not identical).
- Each satellite completes an orbit every 12 hours.
- Satellites orbit the Earth at 20 200 km (12 552 miles) (airplanes routinely fly at 11–13 km [37 000–43 000 feet], the shuttle orbits at 370 km [230 miles]).
- Each satellite has three key pieces of hardware:
 - **Computer.** Controls its flight and order functions.
 - **Atomic clock.** Keeps accurate time within three nanoseconds (approximately three-billionths of a second).
 - **Radio transmitter.** Sends signals to Earth.

Ground stations

The ground control segment of the GPS is comprised of five ground stations that track the satellites, monitor their condition and make any necessary adjustments to keep the system accurate. The entire system functions and is monitored by the US Department of Defence. Information from the stations are sent to a master control station—the Consolidated Space Operations Centre (CSOC) at Schriever Air Force Base in Colorado where the data is processed and adjustments are made. The five ground stations are in Hawaii, Colorado, Diego Garcia, Ascension Island and Kwajalein.

Receivers

GPS receivers make up the user segment. It is the GPS receiver, whether it is in an airplane, a truck, a boat or in a hiker's hand, that detects the radio signals from the satellites and calculates the receiver's position.

When a receiver is turned on, it interprets the radio signals and extracts the satellite location information. The GPS signal broadcasts information that tells the receiver the location of each satellite in the system. The receiver then interprets the radio signal to determine the exact time. This is required to calculate position.

The orbits of the GPS satellites ensure that there will be a minimum of four satellites covering any spot on the globe at all times. The receiver uses the signal from one satellite to continuously monitor and be synchronized with the time maintained by the other satellites. The receiver collects the signals from the other satellites and calculates the difference between them. This calculation positions the receiver from each satellite and triangulates its location. Based on a four-satellite fix, the receiver will identify location giving the user latitude, longitude and altitude (altitude is only possible with a four-satellite fix).

COMPONENTS OF A GPS RECEIVER

Antenna. Allows the GPS receiver to receive satellite signals.

Screen. Displays information.

Battery compartment. Stores the receiver power supply.



The buttons in the following list are found on the Magellan eXplorist 200 GPS receiver. Other makes and models of GPS receivers may have different function buttons. Consult the user manual for GPS receiver button functions.

BUTTONS

On / Off. Turns the receiver on and off.

Backlight. Turns the display backlight on and off and changes intensity.

Enter. Accesses highlighted menu items or highlighted screen menu options.

Escape. Cancels data inputs. Closes the accessed function and goes back to the previous screen and moves backward through the navigation screens.

Zoom in. On the map screen zooms in on the map displayed. The map display can be zoomed in to 35 m (100 feet). Also moves through the list of waypoints when using an alphabetical search.

Zoom out. On the map screen zooms out on the map displayed. The map display can be zoomed out to 2736 km (1700 miles). Also moves through the list of waypoints when using an alphabetical search.

Menu. Displays a menu with available options. Options may be selected by using the arrow joystick to highlight the option and pressing "enter" to access it.

NAV. Moves through the navigation screens (Map screen, Compass screen, Position screen, Satellite screen).

Mark. Saves present position as a waypoint. Waypoints are saved and stored in "My Points of Interest".

GOTO. Creates a one-leg route from the present position to a destination selected from the POI database or by using the cursor on the background map and pressing GOTO on a point.

Arrow joystick. Moves the cursor on the map screen. It also moves the highlighted bar to select menu options and data-entry fields.



Figure C-1 Explorist 200 GPS Receiver

Note. From *Magellan eXplorist 200 Reference Manual* (p. 1), 2004, by Thales Navigation, Inc. Copyright 2004 by Thales Nav, Inc.

SATELLITE STATUS

The satellite status screen displays the acquisition of satellites (satellite signal strength and satellite geometry) and the progress of the collection of satellite data. The receiver is constantly monitoring satellites. The display on the satellite status screen graphically depicts the activity.

As new satellites come into view, a new bar appears in the graph. Bars that were solid minutes ago disappear as satellites pass over the horizon. If a satellite is being monitored but not used, the bar will appear hollow. On Wide Area Augmentation System (WAAS) enabled GPS receivers, the WAAS satellite signal strength is indicated on its own bar on the graph. On this screen it is common for GPS receivers to display the following information:

- satellite signal strengths,
- battery strength, and
- estimated position error (EPE).

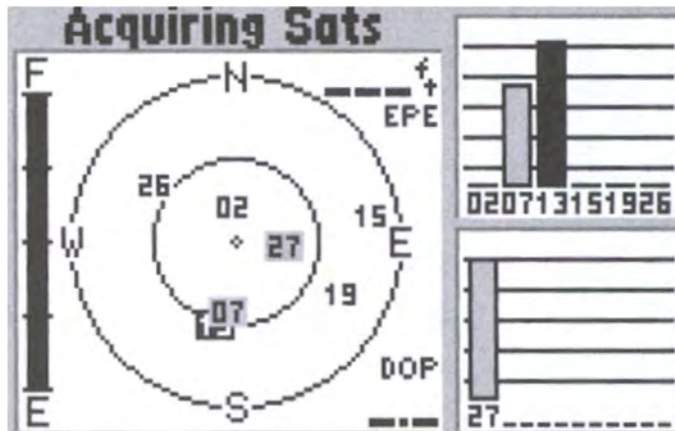

Figure C-2 Satellite Status Screen

Note. From *Outdoor Guide to Using Your GPS* (p. 45), by S. Featherstone, 2004, Chanhassen, MN: Creative Publishing International, Inc.

MENU

This screen is used for customizing the GPS receiver. All data fields can be changed to give a person the information they require including waypoints, routes, time and speed, etc. On this screen it is common for GPS receivers to display the following information:

- customization options for the GPS receiver,
- waypoints and routes, and
- map datum.

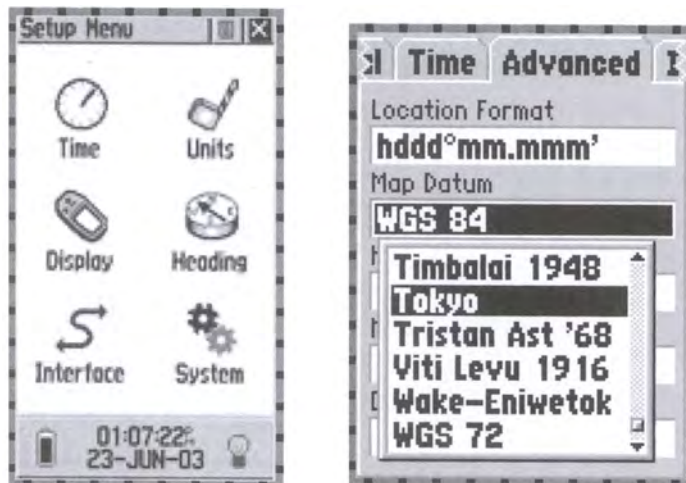

Figure C-3 Menu Screen

Note. From *Outdoor Guide to Using Your GPS* (p. 54), by S. Featherstone, 2004, Chanhassen, MN: Creative Publishing International, Inc.

POSITION

The position screen is used for confirming coordinates, datum, time, date, and the EPE. This screen is used infrequently, for brief periods, mostly in planning and after marking a waypoint. Graphics, like a compass rose, are not displayed. This screen is not ideally laid out for user-friendly navigation.

After acquiring enough satellites to begin navigating, many GPS receivers automatically go to the position screen or the map screen. In addition to the information mentioned above, an operator may find current speed, heading and a trip odometer. On some GPS receivers, the information displayed can be changed.

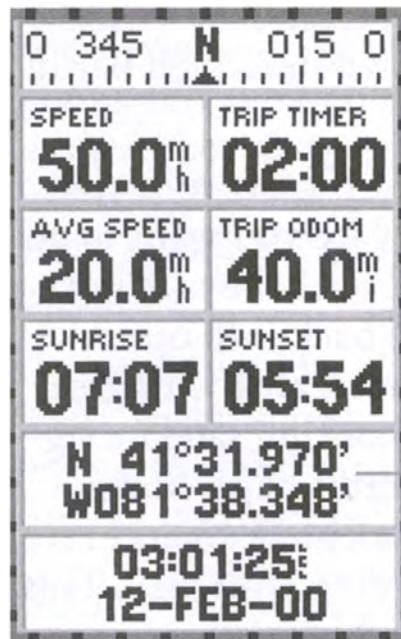

Figure C-4 Position Screen

Note. From *Outdoor Guide to Using Your GPS* (p. 46), by S. Featherstone, 2004, Chanhassen, MN: Creative Publishing International, Inc.

COMPASS NAVIGATION

This screen shows the direction of travel (track) as it relates to the direction of the destination (bearing). It will show the distance from the destination and time to the destination. This screen is used frequently when navigating from point to point and for navigating around obstacles.



The digital compass graphic should not be confused with a real compass. Although they look the same, it can give a very different reading because without movement GPS receivers cannot display direction. Read the owner's manual and determine if the compass is an electronic compass capable of identifying a compass heading while the operator is standing still.



Figure C-5 Compass Navigation Screen

Note. From *Outdoor Guide to Using Your GPS* (p. 47), by S. Featherstone, 2004, Chanhassen, MN: Creative Publishing international, Inc.

MAP

This screen identifies position. A GPS without a built-in map will identify where a person is in relation to another waypoint. A GPS receiver with a built-in map will identify where a person is in relation to landmarks, such as roads, cities and bodies of water. A GPS receiver with downloadable maps will identify where a person is in relation to city streets and topographical features.

The advantage of this screen is its ability to identify the current position by looking at the features on a map rather than just the coordinates. Depending on the zoom level—which is shown at the bottom of the screen—these features may be roads or cities or entire continents.

The map screen allows an operator to pinpoint where they are and create a waypoint on the map by moving the cursor over a feature and pressing ENTER or MARK, making route building easier. The map screen can also serve as an address book. By moving the cursor over a certain waypoint and pressing ENTER, information is displayed, such as phone numbers, addresses, and navigation information.

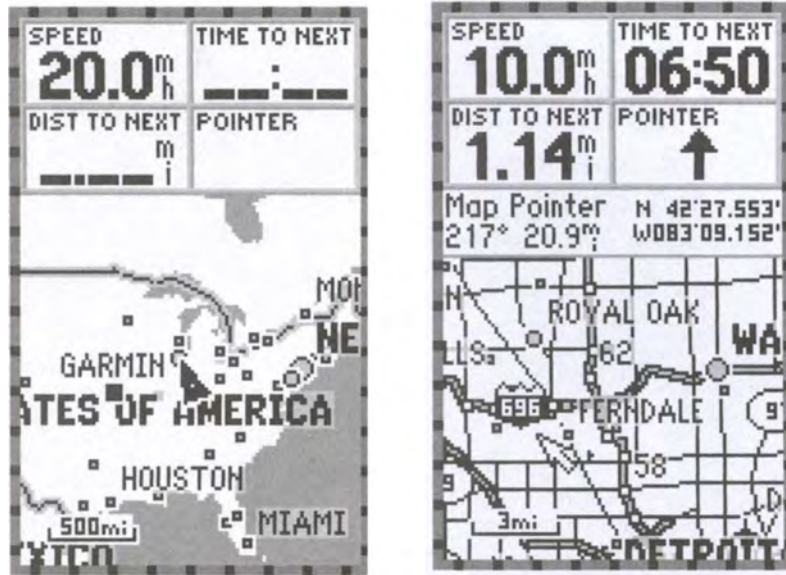

Figure C-6 Map Screen

Note. From *Outdoor Guide to Using Your GPS* (p. 50), by S. Featherstone, 2004, Chanhassen, MN: Creative Publishing International, Inc.

THIS PAGE INTENTIONALLY LEFT BLANK

LEARNING STATION 2 INFORMATION SHEET

PROCESS FOR CONFIRMING CORRECT MGRS COORDINATES

MGRS coordinates allow a GPS receiver to work in conjunction with a topographical map. To confirm the MGRS coordinates correspond with the topographical map the user will have to:

1. Identify the MGRS grid system on the topographical map.
2. Locate the grid zone designator.
3. Confirm the 100 000-m square identifier.

Identifying MGRS Grid System on a Topographical Map

Locating the MGRS grid system on topographical maps provides the navigator with another method to confirm the GPS receiver is reporting coordinates that correspond with the map being used. If the coordinates are different, the navigator will know that the GPS receiver is set to another datum and will have to be adjusted to provide the correct coordinates.

Locating the Grid Zone Designator

The location of the grid zone designator is found in the marginal information. The zone for the example in Figure D-1, is 18 T.

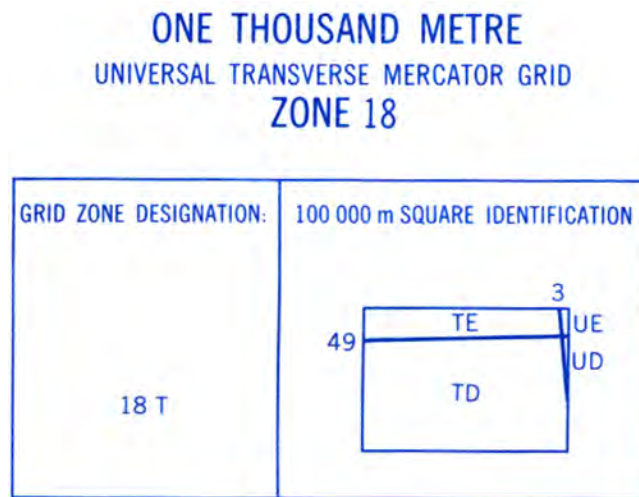

Figure D-1 Grid Zone Designator

Note. Created by Director Cadets 3, 2008, Ottawa, ON: Department of National Defence.

Confirming the 100 000-m Square Identifier

The 100 000-m square identifier is located in the same marginal information area as the grid zone designator. The example in Figure D-1 states that the map is adjacent to the 100 000-m square identifications UE and UD. Additionally when the 100 000-m square identifier on a topographical map joins an adjacent grid zone, the identifier will be noted on the map in the 00 00 grid square. This is illustrated in Figure D-2.

31 C/4

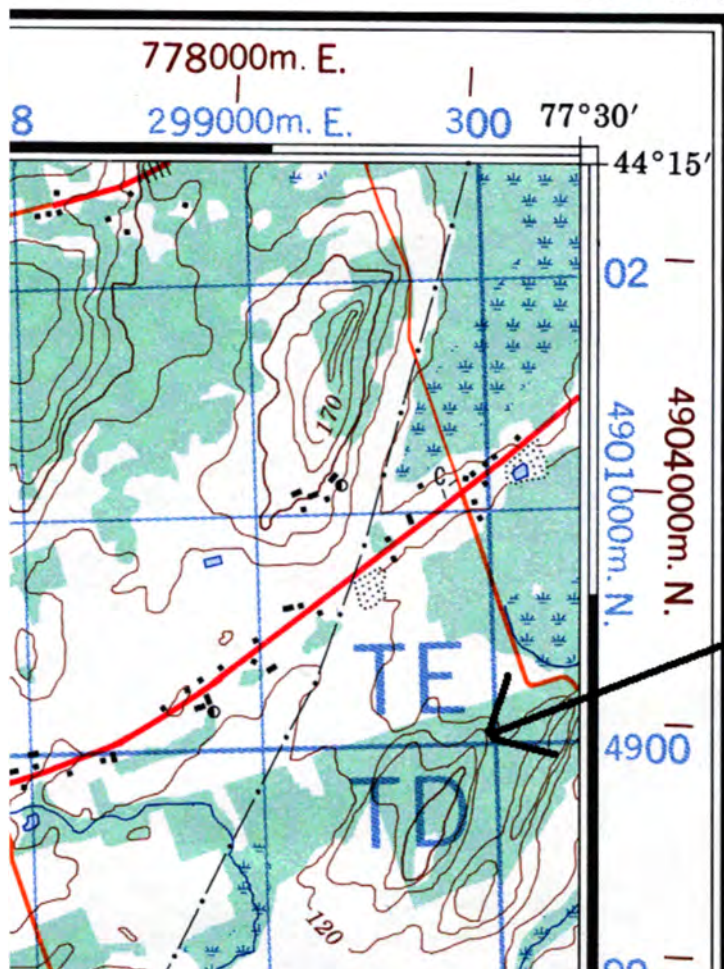
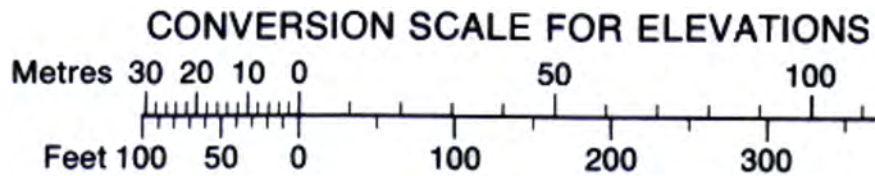

Figure D-2 Topographical Map 100 000-m Square Identifier

Note. Created by Director Cadets 3, 2008, Ottawa, ON: Department of National Defence.

IDENTIFYING THE MAP DATUM FROM A TOPOGRAPHICAL MAP

The map datum of a topographical map is located in the lower right side of the marginal information, under the conversion scale for elevations.



CONTOUR INTERVAL 10 METRES
Elevations in Metres above Mean Sea Level
North American Datum 1927

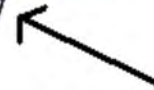

Figure D-3 Map Datum

Note. Created by Director Cadets 3, 2008, Ottawa, ON: Department of National Defence.

SETTING A DATUM ON A GPS

To set a datum on a GPS:

1. Identify the map datum of the topographical map being used as the reference.
2. With the GPS, go to the set-up menu, then NAVIGATION, then SYSTEM or UNITS.
3. Highlight the map datum's box.
4. Scroll through the list of datums and find the map datum being used.
5. Set the correct datum.



To set the datum of the eXplorist 200 GPS receiver:

1. Power up the receiver.
2. Press the ENTER button.
3. Press MENU button.
4. Highlight the preferences and press ENTER.
5. Highlight the map units and press ENTER.
6. Highlight the map datum and press ENTER.
7. Highlight the correct datum and press ENTER.

THIS PAGE INTENTIONALLY LEFT BLANK

LEARNING STATION 3 INFORMATION SHEET

IDENTIFYING MGRS GRID SYSTEM ON A GPS RECEIVER



Ensure that the GPS receiver coordinate system is set to Military Grid Reference System (MGRS).

GPS receivers will identify the UTM coordinates when reading location, to include:

- grid zone designator,
- 100 000-m square identifier, and
- GR.



GPS receivers, depending on the make and model, are capable of selecting an MGRS accuracy of four-, six-, eight-, and ten-figure GRs. If the GPS receiver being used for this TP is enabled with this capability, it is suggested that it be set to a six-figure GR.



GPS Datum Set to NAD-27



GPS Datum Set to NAD-83

Figure E-1 GPS Receiver Coordinates

Note. Created by Director Cadets 3, 2008, Ottawa, ON: Department of National Defence.

The coordinates displayed on the GPS receivers in Figure E-1 are set to MGRS. Each GPS receiver is set with a different datum for the same location.

| GPS Receiver Datum set to NAD-27 | GPS Receiver Datum set to NAD-83 |
|---|---|
| The coordinates are identified as: <ul style="list-style-type: none">• grid zone designator—18 T,• 100 000-m square identifier—TD, and• 10-figure GR as—96785 86748 | The coordinates are identified as: <ul style="list-style-type: none">• grid zone designator—18 T,• 100 000-m square identifier—TP, and• 10-figure GR as—96830 86973 |

| |
|---|
|  Note the difference between the coordinates of the same location using a different datum. |
|---|

PROCESS FOR CONFIRMING CORRECT MGRS COORDINATES

MGRS coordinates allow a GPS receiver to work in conjunction with a topographical map. To confirm the MGRS coordinates correspond with the topographical map the user will have to:

1. identify the MGRS grid system on the topographical map;
2. locate the grid zone designator; and
3. confirm the 100 000-m square identifier.

Identifying the MGRS Grid System on a Topographical Map

Locating the MGRS on topographical maps provides the navigator with another method to confirm the GPS receiver is reporting coordinates that correspond with the map being used. If the coordinates are different, the navigator will know that the GPS receiver is set to another datum and will have to be adjusted to provide the correct coordinates.

Locating the Grid Zone Designator

The location of the grid zone designator is found in the marginal information. The zone for the example in Figure E-1, is 18 T.

ONE THOUSAND METRE
UNIVERSAL TRANSVERSE MERCATOR GRID
ZONE 18

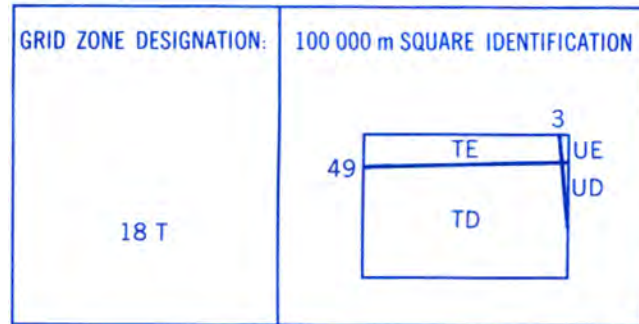

Figure E-2 Grid Zone Designator

Note. Created by Director Cadets 3, 2008, Ottawa, ON: Department of National Defence.

Confirming the 100 000-m Square Identifier

The 100 000-m square identifier is located in the same marginal information area as the grid zone designator. The example in Figure E-2 states that the map is adjacent to the 100 000-m square identifications UE and UD. Additionally, when the 100 000-m square identifier on a topographical map joins an adjacent grid zone, the identifier will be noted on the map in the 00 00 grid square. This is illustrated in Figure E-3.

31 C/4

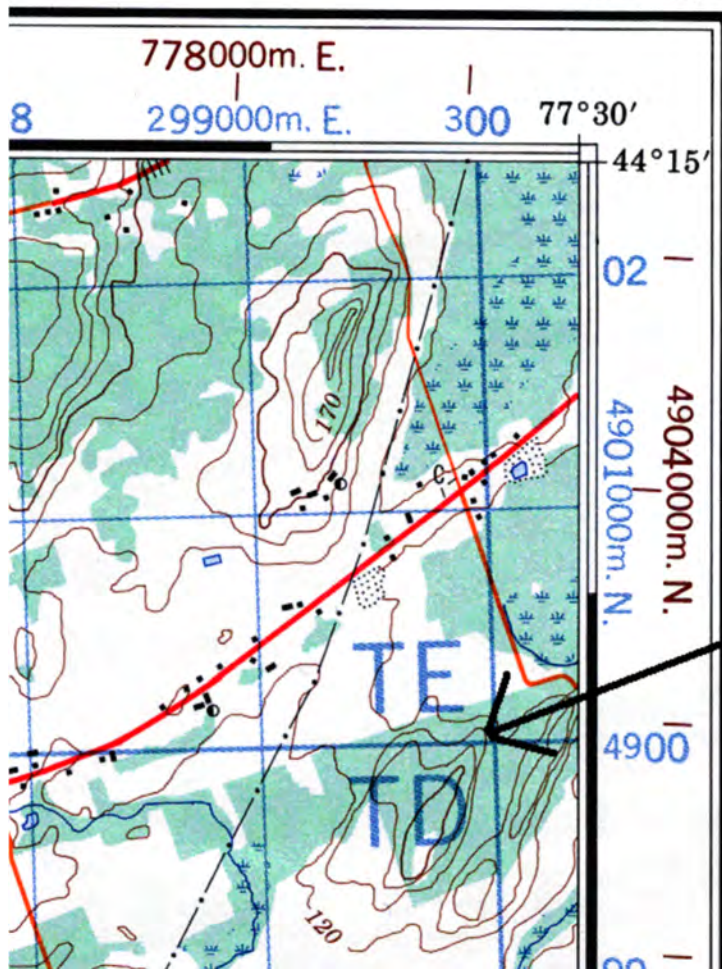

Figure E-3 Topographical Map 100 000-m Square Identifier

Note. Created by Director Cadets 3, 2008, Ottawa, ON: Department of National Defence.

Position. The position screen is used for confirming coordinates, datum, time, date, and the EPE. This screen is used infrequently, for brief periods, mostly in planning and after marking a waypoint. No easy-to-understand graphics, like a compass rose, are displayed.

After acquiring enough satellites to begin navigating, many GPS receivers automatically go to the position screen or the map screen. In addition to the information mentioned above, an operator may find current speed, heading and a trip odometer. On some GPS receivers the information displayed can be changed.



Figure E-4 Position Screen

Note. From *Outdoor Guide to Using Your GPS* (p. 46), by S. Featherstone, 2004, Chanhassen, MN: Creative Publishing International, Inc.

EXTRACTING A 6-FIGURE GR FROM A 10-FIGURE GR

A 10-figure grid reference given from a GPS receiver has 10 digits and is accurate to 1 m. To extract the 6-figure GR from the 10-figure GR one must understand how the figures work.

| GRID REFERENCE WRITTEN FIGURES | | |
|---|---------|----------|
| Definition | Easting | Northing |
| A 10-figure GR accurate to 1 m is written as | 96779 | 86744 |
| An 8-figure GR accurate to 10 m is written as | 9677 | 8674 |
| A 6-figure GR accurate to 100 m of the same coordinates is written as | 967 | 867 |
| A 4-figure GR accurate to 1 000 m of the same coordinates is written as | 96 | 86 |

As illustrated in the above chart, the 10-figure GR has two sets of numbers. The first five digits are eastings and the second five digits are the northing coordinates. When taking a GR from a GPS receiver, it is important to identify the 10 digits and extract the first three numbers from the easting portion and the first three numbers from the northing portion (eg, **96779 86744**). The 6-figure grid reference can then be plotted on a map as GR 967 867.

THIS PAGE INTENTIONALLY LEFT BLANK



ROYAL CANADIAN ARMY CADETS

GOLD STAR

INSTRUCTIONAL GUIDE



SECTION 2

EO M422.02 – SET A MULTI-LEG ROUTE USING A GLOBAL POSITIONING SYSTEM (GPS) RECEIVER

Total Time: 120 min

PREPARATION

PRE-LESSON INSTRUCTIONS

Resources needed for the delivery of this lesson are listed in the lesson specification located in A-CR-CCP-704/PG-001, *Gold Star Qualification Standard and Plan*, Chapter 4. Specific uses for said resources are identified throughout the instructional guide within the TP for which they are required.

Review the lesson content and become familiar with the material prior to delivering the lesson.

All information in this lesson is based on the Magellan eXplorist 200 GPS. If a different GPS receiver is being used, consult the owner's manual to ensure the proper terminology and processes are used for this lesson.

Ensure GPS receivers are set up and initialized prior to the start of the lesson.

Create and input five points of interest (POIs) into each GPS receiver. Personalize these POIs so that they can be easily identified by the cadets during the lesson (eg, Gold 1, Gold 2, Gold 3).

Identify four POIs for the cadets to create in the GPS receiver in TP 2 and then link together to form a multi-leg route in TP 4. The POIs chosen must be able to be linked into a route.

Clear all track logs from the GPS receivers.

Create an active track in the GPS receivers of no longer than 100 m. Have the active track begin and end at the same location where the lesson will be taught. Once the active track has been established, stop it. Before TP 7 begins, resume the active track log on each of the GPS receivers.

PRE-LESSON ASSIGNMENT

Nil.

APPROACH

An interactive lecture was chosen for TPs 1 and 3 to introduce the cadet to the features available on a GPS receiver.

A demonstration and performance was chosen for TPs 2, 4, 5 and 7 as it allows the instructor to explain and demonstrate how to create POIs and routes while providing the cadet the opportunity to practice these skills under supervision.

A demonstration was chosen for TP 6 as it allows the instructor to demonstrate the process of working a GPS receiver providing the cadet with the knowledge on how these skills can be applied in the future.

INTRODUCTION

REVIEW

The review for this lesson is from EO M422.01 (Review Silver Star Navigation).

QUESTIONS:

- Q1. What are the components of a GPS receiver?
- Q2. What are the five screens on a GPS receiver?
- Q3. What does the arrow joystick on the GPS receiver do?

ANTICIPATED ANSWERS:

- A1. The components of a GPS receiver are:
 - antenna,
 - screen,
 - battery compartment, and
 - buttons.
- A2. The five screens on a GPS receiver are:
 - satellite screen,
 - menu screen,
 - position screen,
 - compass navigation screen, and
 - map screen.
- A3. The arrow joystick moves the cursor on the map screen and moves the highlighted bar to select menu options and data-entry fields.

OBJECTIVES

By the end of this lesson the cadet shall have set a multi-leg route using a GPS receiver.

IMPORTANCE

It is important for cadets to be able to set a multi-leg route on a GPS receiver because it allows the cadet to move from point to point without having to input new POIs for each leg, thereby saving time and minimizing the possibility of mistakes.

Teaching Point 1**Identify the two types of POIs.**

Time: 5 min

Method: Interactive Lecture



The purpose of this TP is to introduce the cadets to the two types of POIs that can be used to set a multi-leg route in a GPS receiver.

Depending on the GPS receiver being used, POIs may also be referred to as waypoints or landmarks.

Show cadets each type of POI in the GPS receiver.

The most important function of a GPS receiver is its ability to store POIs because they allow the user to return to a variety of points at a later time. A POI can be anything from a previous campsite to the place where the bus is waiting to pick up the group. POIs can be set prior to leaving or anytime along a route.



An easy way to think about a POI is to think about it as a location on a map marked by a pushpin.

There are two types of POIs:

Marked. A GPS receiver automatically displays the current coordinates of the user's position. Saving this position into the GPS receiver's memory establishes a new POI.

Stored. A POI can also be established even if it is not the user's current position. This stored POI is manually entered coordinates, from the map page of the GPS receiver, or taken from the list of POIs that come pre-loaded into the GPS receiver's memory.



GPS receivers can only store a fixed number of POIs—some limit the user to 250, while others can hold 1 000.

CONFIRMATION OF TEACHING POINT 1**QUESTIONS:**

- Q1. What is a POI?
- Q2. When can POIs be set on a GPS receiver?
- Q3. What is the difference between a marked and a stored POI?

ANTICIPATED ANSWERS:

- A1. A POI can be anything from the previous campsite to the place where the bus is waiting to pick the group up.
- A2. POIs can be set prior to leaving or anytime along a route.
- A3. A marked POI saves the user's current location, while a stored POI is a manually entered GR, from the map page of the GPS receiver, or taken from the list of POIs that come pre-loaded into the GPS receiver's memory.

Teaching Point 2**Explain, demonstrate and have the cadets identify and create POIs.**

Time: 20 min

Method: Demonstration and Performance



For this skill TP it is recommended that instruction take the following format:

1. Identify the components of a POI.
2. Explain and demonstrate each mark while the cadets observe.
3. Explain and demonstrate each step required to complete each mark. Monitor the cadets as they practice each step.
4. Monitor the cadets' performance as they practice each mark.

Note: Assistant instructors may be used to monitor the cadets' performance.



Inform the cadets that once they receive their GPS receiver they will only pick it up when told to do so, follow along with the instructions and only press the buttons they are directed to press.

Distribute the GPS receivers to the class. Depending on the number of GPS receivers available and the number of cadets in the class, some cadets may have to pair up.

IDENTIFY A POI

The following information can be saved in the GPS receiver when a POI is marked in order to distinguish one POI from another:

Location. Indicates the coordinates of the POI, using the coordinate system set on the GPS receiver.

Name. POIs can receive a name of the user's choice or be automatically assigned a number from the GPS receiver. Many GPS receivers limit the number of characters that can be used to name the POI, so some creativity is usually required. Many users develop a list of common abbreviations to use when naming POIs such as CS for campsite, BS for best site, WS for water source, etc.

Date and time. Automatically recorded and saved when a POI is created.

Icon / symbol. Some GPS receivers allow the user to assign an icon / symbol to the newly created POI. This icon / symbol appears on the map page when the area around the POI is displayed. This is an optional feature and is not required—a default icon / symbol appears when one is not selected by the user.

CREATE POIs

Always confirm that the GPS receiver is set to the correct coordinate system and map datum prior to creating POIs.

There are four different ways that POIs can be created and saved into the memory of the GPS receiver. They are created using:

- a quick mark,
- a personalized mark,

- a coordinate mark, and / or
- a map cursor mark.

Quick Mark

The steps to execute a quick mark are as follows:

1. press MARK; and
2. press ENTER.

A quick mark uses the mark position defaults and therefore is not personalized by the user. To distinguish the POI from other POIs it is automatically assigned a number. Numbers are assigned in chronological order and no two POIs have the same number. For example, the first marked POI would be saved as POI001.

Personalized Mark

A personalized mark is inputted in the same way as a quick mark. Once the coordinates have been entered it is then personalized to enable easy identification, by entering:

1. name, and
2. icon / symbol.

The steps to create a POI using a personalized mark are as follows:

1. press MARK;
2. personalize the POI by:
 - a. moving the arrow joystick to highlight the name field;
 - b. pressing ENTER;
 - c. moving the arrow joystick to select the character desired, pressing ENTER after each character is selected;
 - d. moving the arrow joystick to OK, once all characters have been selected;
 - e. pressing ENTER;
 - f. moving the arrow joystick to highlight the icon / symbol field;
 - g. pressing ENTER;
 - h. moving the arrow joystick to the desired icon / symbol; and
 - i. pressing ENTER to select the icon / symbol;
3. move the arrow joystick to highlight the save field; and
4. press ENTER.

Coordinate Mark

A coordinate mark is entered when coordinates from a topographical map are being used or if the user has been given a set of coordinates that they want to make into a POI.

The steps to create a POI using a coordinate mark are as follows:



It is important to make sure that the GPS receiver has been set to the same coordinate system as the coordinates that are going to be entered.

1. press MARK;
2. move the arrow joystick to highlight the location field;
3. press ENTER;
4. use the arrow joystick to adjust the characters in the first line (grid zone designation and 100 000-m square identification) of the location field;
5. press ENTER to move to the second line of the location field;
6. use the arrow joystick to adjust the characters in the second line (grid reference) of the location field;



Moving the arrow joystick in an up / down motion will increase / decrease the value at the cursor point.

Moving the arrow joystick in a left / right motion will move the cursor point to the left / right.

7. press ENTER;
8. personalize the POI, if desired (as detailed in Personalize a Mark, Step 2);
9. move the arrow joystick to the save field; and
10. press ENTER.



Have the cadets input the four POIs identified prior to the lesson using a coordinate mark into the GPS receiver. If the initial POI is the current location, it shall be entered using a personalized mark.

Map Cursor Mark

A map cursor mark allows the user to mark a position, other than the current position, by moving the cursor around the map to a specific place to create a POI.

The steps to create a POI using a map cursor mark are as follows:

1. go to the map screen page of the GPS receiver;
2. move the arrow joystick to put the GPS receiver into cursor mode;
3. move the arrow joystick until it is over the location of the desired POI;
4. press MARK;
5. personalize the POI, if desired (as detailed in Personalize a Mark, Step 2);
6. move the arrow joystick to the save field;

7. press ENTER; and
8. press ESC to exit the cursor mode.

CONFIRMATION OF TEACHING POINT 2

The cadets marking of POIs using the quick mark, personalized mark, coordinate mark, and map cursor mark will serve as the confirmation of this TP.

Teaching Point 3

Discuss types of routes.

Time: 5 min

Method: Interactive Lecture



The purpose of this TP is to introduce the cadets to the different types of routes that can be developed on a GPS receiver. Ensure that the cadets understand the difference between the three routes discussed.

Routes are the least understood and one of the most important functions of a GPS receiver. Understanding how to use routes makes navigating using a GPS receiver much more enjoyable.

Route. A route is a series of POIs strung together to make an electronic path that also represents the trail the user intends to follow.

Leg. The segment between each set of POIs is called a leg.



A single route can be made up of a number of different legs.

There are three different types of routes that can be developed on a GPS receiver.

GOTO route. A GOTO route is the simplest and most common type of route. A GOTO route is a one-leg route with a starting point (present location) and a destination (selected POI). This type of route is useful when travelling to a specific manually-entered or stored POI. GOTO routes can only be used once.

Multi-leg route. A multi-leg route is a number of GOTO routes combined together. For example, if a GOTO route is from point A to point B then a multi-leg route would go from point A to point B to point C to point D and so on. Multi-leg routes can be saved into the memory of the GPS receiver and used repeatedly.

Backtrack route. As an individual walks with their GPS receiver, it records their tracks by automatically saving coordinates. A backtrack route uses these tracks to create a multi-leg route, in reverse order, enabling the user to navigate back to the start location following the same exact path. A backtrack route can be saved into the memory of the GPS receiver and used repeatedly.

CONFIRMATION OF TEACHING POINT 3

QUESTIONS:

- Q1. What is the difference between a route and a leg?
- Q2. What is a multi-leg route?
- Q3. How are the POIs of a backtrack route saved into the GPS receiver?

ANTICIPATED ANSWERS:

- A1. A route is a series of POIs strung together to make an electronic path that also represents the trail the user intends to follow and a leg is the segment between each set of POIs.
- A2. A multi-leg route is a number of GOTO routes combined together.
- A3. The POIs of a backtrack route are saved into the GPS receiver automatically as tracks while the individual walks.

Teaching Point 4

Explain, demonstrate and have the cadets create a GOTO route.

Time: 15 min

Method: Demonstration and Performance



For this skill TP it is recommended that instruction take the following format:

1. Explain and demonstrate creating a GOTO route while the cadets observe.
2. Explain and demonstrate each step required to create a GOTO route. Monitor the cadets as they practice each step.
3. Monitor the cadets' performance as they practice creating a GOTO route and walking to the destination POI.

Note: Assistant instructors may be used to monitor the cadets' performance.



Always confirm that the GPS receiver is set to the correct coordinate system and map datum prior to creating a GOTO route.

A GOTO route is the most commonly route used on a GPS receiver. A GOTO route has the following features:

- It is a straight line from the user's present location to a selected POI.
- It can not be saved.
- It is erased when the GPS receiver is turned off.
- It is created using stored POIs.



All POIs that have been saved or that were pre-loaded into the GPS receiver can be accessed using the POI database. POIs can be searched by nearest to present location or alphabetically. The POI database is accessed by:

1. pressing MENU;
2. using the arrow joystick to highlight POINTS OF INTEREST;
3. pressing ENTER;
4. using the arrow joystick in an up / down motion to highlight MY POINTS OF INTEREST;
5. using the arrow joystick in a left / right motion to select NEAREST or ALPHABETICALLY;
6. pressing ENTER; and
7. using the arrow joystick to highlight the desired POI.

The steps to create a GOTO route are as follows:

1. press GOTO;
2. use the POI database to select (highlight) the POI that will be the destination; and
3. press ENTER.



If there is already an existing GOTO route set, the GPS receiver will ask the user to confirm the creation of the new GOTO route. Pressing ENTER will erase the previous route to create the new route.

Once ENTER has been pressed, the last viewed navigation screen will be displayed, updated with information relating to the GOTO route that was just created. On the map screen, a line will be drawn from the current POI to the destination POI—this represents the GOTO route. The compass screen will change to display the name of the destination POI.



A GOTO route can also be created from a map cursor mark. Cadets will not be required to complete this skill.

The steps to create a GOTO route from a map cursor mark are as follows:

1. while viewing the map screen, use the arrow joystick to turn on the cursor mode;
2. continue using the arrow joystick to move the cursor to a point on the map that represents the desired destination;
3. press GOTO;
4. highlight YES to create a new GOTO route;
5. press ENTER;
6. highlight YES to create GOTO route to the current cursor position; and
7. press ENTER.



Once any route has been set, a GPS receiver indicates the following information:

- distance to the destination POI,
- bearing to the destination POI,
- how long it will take to reach the destination,
- if the user is on / off course, and
- how to get back on course, if off course.

The GPS receiver only indicates distance and bearing when the user is moving forward.



GOTO routes can also be created using the map cursor.



When navigating to a POI the GPS receiver indicates arrival at the destination POI. Depending on the GPS receiver being used, this may be a beep, a vibration or a flash on the screen.

CONFIRMATION OF TEACHING POINT 4

The cadets' creation of a GOTO route will serve as the confirmation of this TP.

Teaching Point 5

Explain, demonstrate and have the cadets create and activate / deactivate a multi-leg route.

Time: 30 min

Method: Demonstration and Performance



For this skill TP it is recommended that instruction take the following format:

1. Explain and demonstrate creating a multi-leg route while the cadets observe.
2. Explain and demonstrate each step required to create a multi-leg route. Monitor the cadets as they practice each step.
3. Explain and demonstrate activating / deactivating a multi-leg route will the cadets observe.
4. Explain and demonstrate each step required to activate / deactivate a multi-leg route. Monitor the cadets as they practice each step.
5. Monitor the cadets' performance as they practice creating a multi-leg route, activating a multi-leg route, navigating using a multi-leg route and deactivating a multi-leg route.

For the practical portion of this TP, cadets will create a multi-leg route with three legs using stored POIs.

Note: Assistant instructors may be used to monitor the cadets' performance.

MULTI-LEG ROUTE



Always confirm that the GPS receiver is set to the correct coordinate system and map datum prior to a multi-leg route.

Multi-leg routes can be used to navigate to a final destination using multiple legs. A route with multiple legs allows the user to incorporate rest stops, terrain features (eg, travelling around a lake), contingency plans, emergency evacuations, etc.

A multi-leg route has the following features:

- It can be saved in the memory of the GPS receiver (the number of routes which can be saved is dependent on the GPS receiver being used).
- It remains active, even after the GPS receiver has been turned off.
- It can be edited, reversed, deleted, or viewed on the map.
- It allows for leg destination points to be switched when the route is active (eg, instead of going to the lake, the user may choose to go directly to the campsite and skip the lake).

Create a Multi-Leg Route

The steps to create a multi-leg route are as follows:

1. press MENU;
2. use the arrow joystick to highlight ROUTES;
3. press ENTER;
4. use the arrow joystick to highlight NEW;
5. press ENTER;
6. ensure ADD POI is highlighted and press ENTER;
7. use the POI database to add POIs by highlighting the desired POI and pressing ENTER after each one;
8. use the arrow joystick to highlight SAVE ROUTE once all the desired POIs have been entered;
9. press ENTER;
10. use the arrow joystick and the ENTER button to input a route name;
11. highlight OK; and
12. press ENTER.

Activate / Deactivate a Multi-Leg Route

Once a multi-leg route has been created, it is saved in the memory of the GPS receiver. While a GOTO route is automatically activated, a multi-leg route must be activated manually by the user. An active route is the route that the user is presently navigating on. A route remains the active route until it is deactivated or a new route is activated.

The steps to activate / deactivate a route are as follows:

1. press MENU;
2. use the arrow joystick to highlight ROUTES;
3. press ENTER;
4. use the arrow joystick to highlight the name of the route that is to be activated / deactivated;
5. press MENU;
6. highlight ACTIVATE ROUTE or DEACTIVATE ROUTE; and
7. press ENTER.

As with a GOTO route, once a multi-leg route has been activated / deactivated the GPS receiver returns to the last viewed navigation screen with the route chosen activated or deactivated.



When navigating using an activated multi-leg route, the GPS receiver indicates when approaching the end of each leg. Once the POI at the end of a leg has been reached, the GPS receiver automatically recalculates to the next leg, until the route is complete.

CONFIRMATION OF TEACHING POINT 5

The cadets' creation of a multi-leg route will serve as the confirmation of this TP.

Teaching Point 6

Demonstrate how to modify a multi-leg route.

Time: 15 min

Method: Demonstration



The purpose of this TP is to demonstrate to cadets the different ways to modify an established multi-leg route. Demonstrate each skill, ensuring that the cadets can see the GPS receiver. If an assistant instructor is available, divide the cadets into two groups and have the assistant instructor demonstrate to one group.

MODIFY A MULTI-LEG ROUTE

Once a multi-leg route has been created, there may be a requirement to modify some aspects of the route. There are four ways to modify a multi-leg route:

- change the destination leg of an active route;
- edit a saved route;
- reverse the route; and
- delete a route.

Change the Destination Leg of an Active Route

When created, a multi-leg route will have many different legs incorporated into it—with each leg having its own destination. In some instances, the user may want to skip a leg and move directly to the next leg. The GPS

receiver allows the user to change the destination leg and then recalculates the navigation instructions based on the new destination.



Use the following multi-leg route which begins at the campground as an example:

- the first leg takes the user from the campground to the bridge;
- the second leg takes the user from the bridge to the lake; and
- the third leg takes the user from the lake to the park where lunch will be served.

The route would be campground > bridge > lake > park.

The user could decide to skip the lake and go directly to the park, by changing the destination leg from the lake to the park.



The destination leg of a route can only be changed if the route is active.

The steps to change the destination leg of an active route are as follows:

1. press MENU;
2. use the arrow joystick to highlight ROUTES;
3. press ENTER;
4. use the arrow joystick to highlight the active route;
5. press MENU;
6. highlight SELECT LEG;
7. press ENTER;
8. use the arrow joystick to highlight the new destination POI from the route list (in the example it would be 'park');



The current active leg in the route list will be bolded.

9. press ENTER;
10. use the arrow joystick to highlight YES and confirm the action;
11. press ENTER; and
12. press NAV to return to the last viewed navigation screen.

The multi-leg route recalculates and the user is able to navigate to the new destination.

Edit a Saved Route

A saved multi-leg route can be edited by:

- adding a leg;
- inserting a new leg;
- deleting a leg; or
- replacing a leg.

The steps to edit a saved multi-leg route are as follows:

1. press ENTER;
2. use the arrow joystick to highlight ROUTES;
3. press ENTER;
4. use the arrow joystick to highlight the name of the route that is to be edited;
5. press ENTER;
6. choose any of the following:
 - a. add a leg:
 - (1) use the arrow joystick to highlight ADD POI;
 - (2) press ENTER;
 - (3) search the POI database for the new POI; and
 - (4) highlight the desired POI and press ENTER;



The new POI is added to the end of the route.

- b. insert a new leg:
 - (1) use the arrow joystick to highlight the POI that the new leg will be inserted in front of;
 - (2) press MENU;
 - (3) highlight INSERT POI;
 - (4) press ENTER;
 - (5) search the POI database for the new POI; and
 - (6) highlight the desired POI and press ENTER;
- c. delete a leg:
 - (1) use the arrow joystick to highlight the POI that is to be deleted;
 - (2) press MENU;

- (3) highlight DELETE POI; and
- (4) press ENTER;
- d. replace a leg:
 - (1) use the arrow joystick to highlight the POI that is to be replaced;
 - (2) press MENU;
 - (3) highlight REPLACE POI;
 - (4) press ENTER;
 - (5) search the POI database for the new POI; and
 - (6) highlight the desired POI and press ENTER;
7. use the arrow joystick to highlight SAVE ROUTE once the route has been edited;
8. press ENTER;
9. highlight OK;
10. press ENTER.

Reverse a Route

Reversing a route takes a previously saved route and recreates it in the reverse order.



Using the previous multi-leg route example, the reverse route would be park > lake > bridge > campground.

The steps to reverse a route are as follows:

1. press MENU;
2. use the arrow joystick to highlight ROUTES;
3. press ENTER;
4. use the arrow joystick to highlight the name of the route that is to be reversed;
5. press MENU;
6. highlight REVERSE ROUTE; and
7. press ENTER.

Delete a Route

The number of routes that can be saved in the GPS receiver's memory depends on the GPS receiver being used. Once the memory is full, routes have to be deleted to add new routes.

The steps to delete a route are as follows:

1. press MENU;
2. use the arrow joystick to highlight ROUTES;

3. press ENTER;
4. use the arrow joystick to highlight the name of the route to be deleted;
5. highlight DELETE ROUTE;
6. press ENTER;
7. highlight YES to confirm the deletion; and
8. press ENTER.

CONFIRMATION OF TEACHING POINT 6

QUESTIONS:

- Q1. What are the four ways to modify a multi-leg route?
- Q2. Changing the destination leg of a route allows the user to do what?
- Q3. What should the user do if the GPS receiver's memory is full and they can not add a new multi-leg route?

ANTICIPATED ANSWERS:

- A1. The four ways to modify a multi-leg route are:
 - change the destination leg of an active route;
 - edit a saved route;
 - reverse the route; and
 - delete a route.
- A2. Changing the destination leg of a route allows the user to skip a leg(s) of an active route.
- A3. If the GPS receiver's memory is full the user has to delete a route.

Teaching Point 7

Explain, demonstrate and have the cadets create and deactivate a backtrack route.

Time: 20 min

Method: Demonstration and Performance



For this skill TP it is recommended that instruction take the following format:

1. Explain and demonstrate creating a backtrack route from a track log while the cadets observe.
2. Explain and demonstrate each step required to create a backtrack route from a track log. Monitor the cadets as they practice each step.
3. Monitor the cadets' performance as they practice creating a backtrack route from a track log and walk on that route.

Ensure that the track log is resumed on the cadets GPS receivers.

Note: Assistant instructors may be used to monitor the cadets' performance.



Tracks. The coordinates of the user's current position. They are automatically created and saved into the memory of the GPS receiver when it is turned on and the tracks feature is enabled.

Track log. A series of tracks strung together. Tracks automatically become a track log that, if the user chooses, can be saved for use later. A track log can also be made into:

- a multi-leg route, and / or
- a backtrack route.

Track logs are not recorded when the GPS receiver is turned off or if it loses satellite reception.



Ensure that the cadets understand that the track log function can be turned on and turned off, that track logs can be saved and tracks can be cleared. They will not be required to complete these skills.

To enable the track log:

1. press MENU;
2. use the arrow joystick highlight TRACK LOG;
3. press ENTER;
4. use the arrow joystick to highlight ACTIVE TRACK;
5. press MENU;
6. highlight NEW TRACK; and
7. press ENTER.

To stop / resume a track log:

1. press MENU;
2. use the arrow joystick to highlight TRACK LOG;
3. press MENU with the ACTIVE TRACK highlighted;
4. highlight STOP LOGGING / RESUME LOGGING; and
5. press ENTER.

To save a track log:

1. press MENU;
2. use the arrow joystick highlight TRACK LOG;
3. press ENTER;
4. use the arrow joystick to highlight ACTIVE TRACK;
5. press MENU;

6. highlight SAVE;
7. press ENTER;
8. use the arrow joystick and the ENTER button to assign the track a name;
9. use the arrow joystick to highlight OK; and
10. press ENTER.

To clear the active track:

1. press MENU;
2. use the arrow joystick to highlight TRACK LOG;
3. press ENTER;
4. use the arrow joystick to highlight ACTIVE TRACK;
5. press MENU;
6. highlight clear TRACK;
7. press ENTER.

BACKTRACK ROUTE

A backtrack route uses track logs to create a route that returns the user to their start point following the exact path that was taken.

The steps to creating a backtrack route are as follows:

1. press MENU;
2. use the arrow joystick to highlight TRACK LOG;
3. press ENTER;
4. use the arrow joystick to highlight ACTIVE TRACK;
5. press MENU;
6. highlight BACKTRACK;
7. press ENTER; and
8. press ENTER.



Once a backtrack route has been activated, the GPS receiver no longer records track information.

The steps to deactivating a backtrack route are as follows:

1. press MENU;
2. highlight TRACK LOG;
3. press MENU;

4. highlight ACTIVE TRACK;
5. press MENU;
6. highlight DEACTIVATE;
7. press ENTER; and
8. press ENTER.

CONFIRMATION OF TEACHING POINT 7

The cadets' creation of a backtrack route will serve as the confirmation of this TP.

END OF LESSON CONFIRMATION

The cadets' creation of a GOTO route, a multi-leg route and a backtrack route will serve as the confirmation of this lesson.

CONCLUSION

HOMEWORK / READING / PRACTICE

Nil.

METHOD OF EVALUATION

This lesson is assessed IAW A-CR-CCP-704/PG-001, *Gold Star Qualification Standard and Plan*, Chapter 3, Annex B, 422 PC.

CLOSING STATEMENT

Being able to set a multi-leg route is one of the most important skills to master when using a GPS receiver. The establishment of a route ensures efficient and accurate travel from POI to POI, making the experience more enjoyable for all.

INSTRUCTOR NOTES / REMARKS

GPS receiver instructions are based on the Magellan eXplorist 200. For instruction on use with other GPS receiver models, refer to the user's manual.

This EO shall be conducted during the allocated bivouac field training exercise.

REFERENCES

C1-178 Thales Navigation Inc. (2004). *Magellan eXplorist 200 GPS user manual*. San Dimas, CA: Thales Navigation Inc.

THIS PAGE INTENTIONALLY LEFT BLANK



ROYAL CANADIAN ARMY CADETS
GOLD STAR
INSTRUCTIONAL GUIDE



SECTION 3

**EO M422.03 – FOLLOW A MULTI-LEG ROUTE USING
 A GLOBAL POSITIONING SYSTEM (GPS) RECEIVER**

| | |
|-------------|--------|
| Total Time: | 90 min |
|-------------|--------|

PREPARATION

PRE-LESSON INSTRUCTIONS

Resources needed for the delivery of this lesson are listed in the lesson specification located in A-CR-CCP-704/PG-001, *Gold Star Qualification Standard and Plan*, Chapter 4. Specific uses for said resources are identified throughout the instructional guide within the TP for which they are required.

Review the lesson content and become familiar with the material prior to delivering the lesson.

Photocopy Attachment A (Input a Multi-Leg Route in the Magellan eXplorist 200 GPS Receiver) for each cadet.

Design a 4-km route with a minimum of 12 legs.

Assistant instructors are required for this lesson.

PRE-LESSON ASSIGNMENT

Nil.

APPROACH

A practical activity was chosen for this lesson as it is an interactive way to allow cadets to experience following a multi-leg route using a GPS receiver in a safe and controlled environment.

INTRODUCTION

REVIEW

The review for this lesson is from EO M422.02 (Set a Multi-Leg Route Using a Global Positioning System [GPS] Receiver).

QUESTIONS:

- Q1. Describe the differences between the two types of points of interest (POIs).
- Q2. What are the steps to create a personalized mark?
- Q3. What is a GOTO route?

ANTICIPATED ANSWERS:

- A1. A marked POI saves the user's current location, while a stored POI can be a manually entered GR. It can be marked from the map page of the GPS receiver, or it can be taken from the list of POIs that come pre-loaded into the GPS receiver's memory.
- A2. To create a personalized mark:
1. press MARK;
 2. personalize the POI by:
 - (a) moving the arrow joystick to highlight the name field;
 - (b) pressing ENTER;
 - (c) moving the arrow joystick to select the character desired, pressing ENTER after each character is selected;
 - (d) moving the arrow joystick to OK once all characters have been selected;
 - (e) pressing ENTER;
 - (f) moving the arrow joystick to highlight the icon / symbol field;
 - (g) pressing ENTER;
 - (h) moving the arrow joystick to the desired icon / symbol; and
 - (i) pressing ENTER to select the icon / symbol;
 3. move the arrow joystick to highlight the save field; and
 4. press ENTER.
- A3. A GOTO route is the simplest and most common type of route. A GOTO route is a one-leg route with a starting point (present location) and a destination (selected POI). This type of route is useful when travelling to a specific manually entered or stored POI. GOTO routes can only be used once.

OBJECTIVES

By the end of this lesson the cadet shall have followed a multi-leg route using a GPS receiver.

IMPORTANCE

It is important for cadets to know how to follow a multi-leg route using a GPS receiver as each leg represents a checkpoint during an expedition. Breaking the expedition into legs allows for planning in rest points, meal locations, sleep locations and ensures that cadets feel a sense of success as the expedition progresses. Multi-leg routes also reaffirm the group is on the correct course, limiting the chances of becoming lost.

Teaching Point 1

Have the cadets, in groups of four, practice following a multi-leg route using a GPS receiver.

Time: 80 min

Method: Practical Activity

BACKGROUND KNOWLEDGE

PROCESS FOR CONFIRMING CORRECT MILITARY GRID REFERENCE SYSTEM (MGRS) COORDINATES

MGRS coordinates allow a GPS receiver to work in conjunction with a topographical map. To confirm the MGRS coordinates correspond with the topographical map, the user will have to:

1. Identify the MGRS grid system on the topographical map.
2. Locate the grid zone designator.
3. Confirm the 100 000-m square identifier.

Identifying MGRS Grid System on a Topographical Map

Locating the MGRS grid system on topographical maps provides the cadet with another method to confirm the GPS receiver is reporting coordinates that correspond with the map being used. If the coordinates are different, the navigator will know that the GPS receiver is set to another datum and will have to be adjusted to provide the correct coordinates.

Locating the Grid Zone Designator

The location of the grid zone designator is found in the marginal information. The zone for the example in Figure 1 is 18 T.

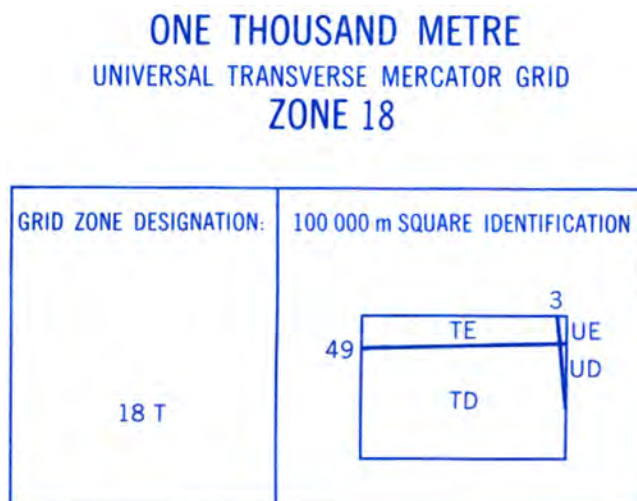

Figure 1 Grid Zone Designator

Note. Created by Director Cadets 3, 2008, Ottawa, ON: Department of National Defence.

Confirming the 100 000-m Square Identifier

The 100 000-m square identifier is located in the same marginal information area as the grid zone designator. The example in Figure 1 states that the map is adjacent to the 100 000-m square identifications UE and UD. Additionally when the 100 000-m square identifier on a topographical map joins an adjacent grid zone, the identifier will be noted on the map in the 00 00 grid square. This is illustrated in Figure 2.

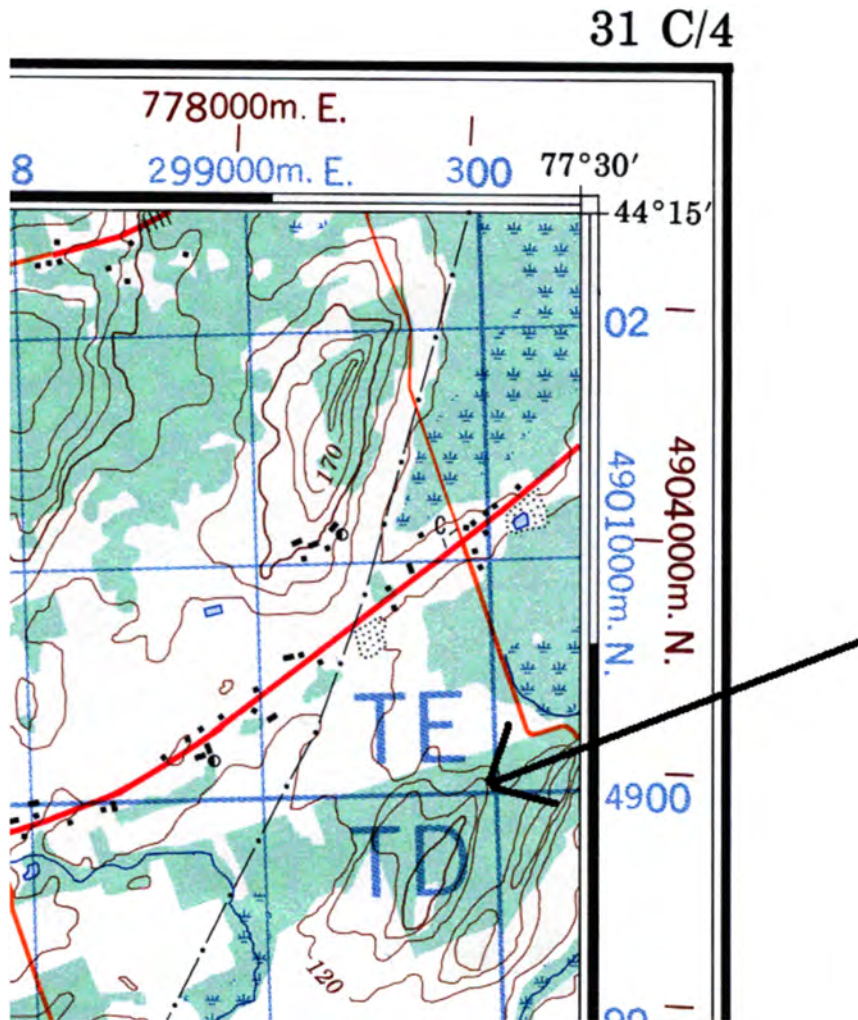

Figure 2 Topographical Map 100 000-m Square Identifier

Note. Created by Director Cadets 3, 2008, Ottawa, ON: Department of National Defence.

IDENTIFYING THE MAP DATUM FROM A TOPOGRAPHICAL MAP

The map datum of a topographical map is located in the lower right side of the marginal information, under the conversion scale for elevations.

Information concerning bench marks and horizontal survey monuments can be obtained from Geodetic Survey, Canada Centre for Surveying, Ottawa.

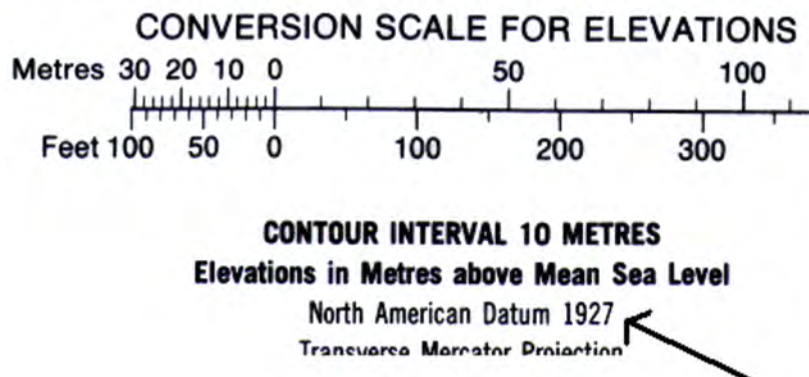

Figure 3 Map Datum

Note. Created by Director Cadets 3, 2008, Ottawa, ON: Department of National Defence.

SETTING A DATUM ON A GPS

To set a datum on a GPS:

1. Identify the map datum of the topographical map being used as the reference.
2. With the GPS, go to the set-up menu, then "navigation", then "system" or "units".
3. Highlight the map datum's box.
4. Scroll through the list of datums and find the map datum being used.
5. Set the correct datum.



To set the datum of the eXplorist 200 GPS receiver:

1. Power up the receiver.
2. Press the ENTER button.
3. Press MENU button.
4. Highlight the preferences and press ENTER.
5. Highlight the map units and press ENTER.
6. Highlight the map datum and press ENTER.
7. Highlight the correct datum and press ENTER.

IDENTIFYING MGRS GRID SYSTEM ON A GPS RECEIVER



Ensure that the GPS receiver coordinate system is set to Military Grid Reference System (MGRS).

GPS receivers will identify the Universe Transverse Mercator (UTM) coordinates when reading location, to include:

- grid zone designator,
- 100 000-m square identifier, and
- GR.

 GPS receivers, depending on the make and model, are capable of selecting an MGRS accuracy of four-, six-, eight-, and ten-figure GRs. If the GPS receiver being used for this TP is enabled with this capability, it is suggested that it be set to a six-figure GR.



GPS Datum Set to NAD-27



GPS Datum Set to NAD-83

Figure 4 GPS Receiver Coordinates

Note. Created by Director Cadets 3, 2008, Ottawa, ON: Department of National Defence.

The coordinates displayed on the GPS receivers in Figure 4 are set to MGRS. Each GPS receiver is set with a different datum for the same location.

| GPS Receiver Datum Set to NAD-27 | GPS Receiver Datum Set to NAD-83 |
|---|---|
| The coordinates are identified as: <ul style="list-style-type: none"> • grid zone designator—18 T, • 100 000-m square identifier—TD, and • 10-figure GR as—96785 86748 | The coordinates are identified as: <ul style="list-style-type: none"> • grid zone designator—18 T, • 100 000-m square identifier—TP, and • 10-figure GR as—96830 86973 |



Note the difference between the coordinates of the same location using a different datum.

Position. The position screen is used for confirming coordinates, datum, time, date, and the estimated position error (EPE). This screen is used infrequently, for brief periods, mostly in planning and after marking a waypoint. No easy-to-understand graphics, like a compass rose, are displayed.

After acquiring enough satellites to begin navigating, many GPS receivers automatically go to the position screen or the map screen. In addition to the information mentioned above, an operator may find current speed, heading and a trip odometer. On some GPS receivers the information displayed can be changed.



Figure 5 Position Screen

Note. From *Outdoor Guide to Using Your GPS* (p. 46), by S. Featherstone, 2004, Chanhassen, MN: Creative Publishing International, Inc.

EXTRACTING A 6-FIGURE GR FROM A 10-FIGURE GR

A 10-figure grid reference given from a GPS receiver has 10 digits and is accurate to 1 m. To extract the 6-figure GR from the 10-figure GR one must understand how the figures work.

| GRID REFERENCE WRITTEN FIGURES | | |
|---|---------|----------|
| Definition | Easting | Northing |
| A 10-figure GR accurate to 1 m is written as | 96779 | 86744 |
| An 8-figure GR accurate to 10 m is written as | 9677 | 8674 |
| A 6-figure GR accurate to 100 m of the same coordinates is written as | 967 | 867 |
| A 4-figure GR accurate to 1 000 m of the same coordinates is written as | 96 | 86 |

As illustrated in the above chart, the 10-figure GR has two sets of numbers. The first five digits are eastings and the second five digits are the northing coordinates. When taking a GR from a GPS, receiver it is important

to identify the 10 digits and extract the first three numbers from the easting portion and the first three numbers from the northing portion (eg, **96779 86744**). The 6-figure grid reference can then be plotted on a map as GR 967 867.

CREATING A PERSONALIZED MARK

The steps to create a personalized mark are as follows:

1. press MARK;
2. personalize the POI by:
 - a. moving the arrow joystick to highlight the name field;
 - b. pressing ENTER;
 - c. moving the arrow joystick to select the character desired, pressing ENTER after each character is selected;
 - d. moving the arrow joystick to OK, once all characters have been selected;
 - e. pressing ENTER;
 - f. moving the arrow joystick to highlight the icon / symbol field;
 - g. pressing ENTER;
 - h. moving the arrow joystick to the desired icon / symbol; and
 - i. pressing ENTER to select the icon / symbol;
3. move the arrow joystick to highlight the save field; and
4. press ENTER.

CREATING A COORDINATE MARK

The steps to create a coordinate mark are as follows:

| | |
|---|--|
|  | It is important to make sure that the GPS receiver has been set to the same coordinate system as the coordinates that are going to be entered. |
|---|--|

1. press MARK;
2. move the arrow joystick to highlight the location field;
3. press ENTER;
4. use the arrow joystick to adjust the characters in the first line (grid zone designation and 100 000-m square identification) of the location field;
5. press ENTER to move to the second line of the location field;
6. use the arrow joystick to adjust the characters in the second line (grid reference) of the location field;

| | |
|---|--|
|  | Moving the arrow joystick in an up / down motion will increase / decrease the value at the cursor point. Moving the arrow joystick in a left / right motion will move the cursor point to the left / right. |
|---|--|

7. press ENTER;
8. personalize the POI, if desired (as detailed personalize a mark, Step 2);
9. move the arrow joystick to the save field; and
10. press ENTER.

CREATING A MULTI-LEG ROUTE

The steps to create a multi-leg route are as follows:

1. press MENU;
2. use the arrow joystick to highlight ROUTES;
3. press ENTER;
4. use the arrow joystick to highlight NEW;
5. press ENTER;
6. ensure 'add POI' is highlighted and press ENTER;
7. use the POI database to add POIs by highlighting the desired POI and pressing ENTER after each one;
8. use the arrow joystick to highlight SAVE ROUTE once all the desired POIs have been entered;
9. press ENTER;
10. use the arrow joystick and the ENTER button to input a route name;
11. highlight OK; and
12. press ENTER.

ACTIVATING A MULTI-LEG ROUTE

The steps to activate a multi-leg route are as follows:

1. press MENU;
2. use the arrow joystick to highlight ROUTES;
3. press ENTER;
4. use the arrow joystick to highlight the name of the route that is to be activated;
5. press MENU;
6. highlight ACTIVATE ROUTE; and
7. press ENTER.

ACTIVITY

Time: 80 min

OBJECTIVE

The objective of this activity is to have the cadets, in a group of no more than four, follow a multi-leg route using a GPS receiver.

RESOURCES

- GPS receiver (one per group),
- Start point,
- Three POIs (per group),
- Compass (one per group),
- Topographical map of the local area (one per group),
- Whistle (one per cadet),
- First aid kit (one),
- Hand-held radio (one per group), and
- Input a Multi-leg Route in the Magellan eXplorist 200 GPS Receiver handout located at Attachment A (one per cadet).

ACTIVITY LAYOUT

Break the route into three legs (POIs) for each group.

ACTIVITY INSTRUCTIONS

1. Brief the cadets prior to the start of the activity, to include an explanation of:
 - a. the objectives and importance of the activity;
 - b. the coordinates they will require to input their routes, including start and end points and the POIs; and
 - c. any safety guidelines that must be followed while performing the activity.
2. Divide cadets into groups of no more than four.
3. Provide one GPS receiver, topographical map of the local area, compass and hand-held radio to each group.
4. Provide a whistle and a copy of the Input a Multi Leg Route in the Magellan eXplorist 200 GPS Receiver handout to each cadet.
5. Have each group determine who will navigate each leg.
6. Assign each cadet within each group their POI coordinates.

7. Have the cadets, in navigating order, input their provided coordinates using a GPS receiver by:
 - a. confirming that the GPS receiver is set to the correct coordinate system;
 - b. confirming that the correct map datum is set;
 - c. marking the start point, using a personalized mark by:
 - (1) pressing MARK;
 - (2) personalizing the POI by:
 - (a) moving the arrow joystick to highlight the name field;
 - (b) pressing ENTER;
 - (c) moving the arrow joystick to select the character desired, pressing ENTER after each character is selected;
 - (d) moving the arrow joystick to OK once all characters have been selected;
 - (e) pressing ENTER;
 - (f) moving the arrow joystick to highlight the icon / symbol field;
 - (g) pressing ENTER;
 - (h) moving the arrow joystick to the desired icon / symbol; and
 - (i) pressing ENTER to select the icon / symbol;
 - (3) moving the arrow joystick to highlight the save field; and
 - (4) pressing ENTER;
 - d. establishing three POIs using coordinate marks by:
 - (1) pressing MARK;
 - (2) moving the arrow joystick to highlight the location field;
 - (3) pressing ENTER;
 - (4) using the arrow joystick to adjust the characters in the first line (grid zone designation and 100 000-m square identification), as required;
 - (5) pressing ENTER to move to the second line of the location field;
 - (6) using the arrow joystick to adjust the characters in the second line (grid reference) of the location field;
 - (7) pressing ENTER;
 - (8) personalizing the POI, if desired;
 - (9) moving the arrow joystick to the save field;
 - (10) pressing ENTER; and
 - (11) repeating the process for the remaining POIs; and

- e. creating a multi-leg route by:
 - (1) pressing MENU;
 - (2) using the arrow joystick to highlight ROUTES;
 - (3) pressing ENTER;
 - (4) using the arrow joystick to highlight NEW;
 - (5) pressing ENTER;
 - (6) ensuring ADD POI is highlighted and pressing ENTER;
 - (7) using the POI database to add POIs by highlighting the desired POI and pressing ENTER after each one;
 - (8) using the arrow joystick to highlight SAVE ROUTE once all the desired POIs have been entered;
 - (9) pressing ENTER;
 - (10) using the arrow joystick and the ENTER button to input a route name;
 - (11) highlighting OK; and
 - (12) pressing ENTER.
- 8. Have the cadets, in navigating order:
 - a. activate the route by:
 - (1) pressing MENU;
 - (2) using the arrow joystick to highlight ROUTES;
 - (3) pressing ENTER;
 - (4) using the arrow joystick to highlight the name of the route that is to be activated;
 - (5) pressing MENU;
 - (6) highlighting ACTIVATE ROUTE; and
 - (7) pressing ENTER; and
 - b. navigate to each POI along the set route using the GPS receiver (within a 10-m radius).
- 9. Debrief the cadets by asking:
 - a. how they felt about the activity;
 - b. what part of the activity they found difficult;
 - c. what they felt they accomplished; and
 - d. what they would try to improve if given the chance to complete the activity again.

SAFETY

Cadets will be navigating legs on their own. Additional instructors will be required to monitor the activity by positioning themselves in random locations along the route.

Provide cadets with a safety bearing to travel on in the case of GPS receiver fails or in the event of becoming lost.

END OF LESSON CONFIRMATION

The cadets' participation in the GPS navigation activity will serve as the confirmation of this lesson.

CONCLUSION

REVIEW

Nil.

HOMEWORK / READING / PRACTICE

Nil.

METHOD OF EVALUATION

This lesson is assessed IAW A-CR-CCP-704/PG-001, *Gold Star Qualification Standard and Plan*, Chapter 3, Annex B, 422 PC.

CLOSING STATEMENT

The ability to identify route legs and input those legs into a GPS allows one to divide up the route when navigating. Dividing the expedition route into legs allows the leader to prepare for rest stops, meal breaks and particular points to use as overnight rest points. A leg also provides the group with minor points of accomplishments and promotes individual and team morale.

INSTRUCTOR NOTES / REMARKS

This EO shall be conducted during the allocated bivouac field training exercise.

Additional instructors will be required to supervise the cadets while participating in the activity. Assistant instructors shall be randomly placed along the route to assist cadets.

The type of GPS receiver may vary. If the Magellan eXplorist 200 is not being used to refer the owner's manual for instructions and proper methods of use.

REFERENCES

C1-178 Thales Navigation Inc. (2004). *Magellan eXplorist 200 GPS user manual*. San Dimas, CA: Thales Navigation Inc.

THIS PAGE INTENTIONALLY LEFT BLANK

Input a Multi-Leg Route in the Magellan eXplorist 200 GPS Receiver

To input a multi-leg route in a GPS receiver:

1. Confirm that the GPS receiver is set to the correct coordinate system.
2. Confirm that the correct map datum is set.
3. Mark the start point, using a personalized mark by:
 - a. pressing MARK;
 - b. personalizing the POI by:
 - (1) moving the arrow joystick to highlight the name field;
 - (2) pressing ENTER;
 - (3) moving the arrow joystick to select the character desired, pressing ENTER after each character is selected;
 - (4) moving the arrow joystick to OK once all characters have been selected;
 - (5) pressing ENTER;
 - (6) moving the arrow joystick to highlight the icon / symbol field;
 - (7) pressing ENTER;
 - (8) moving the arrow joystick to the desired icon / symbol; and
 - (9) pressing ENTER to select the icon / symbol;
 - c. moving the arrow joystick to highlight the save field; and
 - d. pressing ENTER.
4. Establish three POIs using coordinate marks by:
 - a. pressing MARK;
 - b. moving the arrow joystick to highlight the location field;
 - c. pressing ENTER;
 - d. using the arrow joystick to adjust the characters in the first line (grid zone designation and 100 000-m square identification), as required;
 - e. pressing ENTER to move to the second line of the location field;
 - f. using the arrow joystick to adjust the characters in the second line (grid reference) of the location field;
 - g. pressing ENTER;
 - h. personalizing the POI, if desired;
 - i. moving the arrow joystick to the save field;

- j. pressing ENTER; and
 - k. repeating the process for the remaining POIs.
5. Create a multi-leg route by:
- a. pressing MENU;
 - b. using the arrow joystick to highlight ROUTES;
 - c. pressing ENTER;
 - d. using the arrow joystick to highlight NEW;
 - e. pressing ENTER;
 - f. ensuring ADD POI is highlighted and pressing ENTER;
 - g. using the POI database to add POIs by highlighting the desired POI and pressing ENTER after each one;
 - h. using the arrow joystick to highlight SAVE ROUTE once all the desired POIs have been entered;
 - i. pressing ENTER;
 - j. using the arrow joystick and the ENTER button to input a route name;
 - k. highlighting OK; and
 - l. pressing ENTER.
6. Activate the route by:
- a. pressing MENU;
 - b. using the arrow joystick to highlight ROUTES;
 - c. pressing ENTER;
 - d. using the arrow joystick to highlight the name of the route that is to be activated;
 - e. pressing MENU;
 - f. highlighting ACTIVATE ROUTE; and
 - g. pressing ENTER.



ROYAL CANADIAN ARMY CADETS
GOLD STAR
INSTRUCTIONAL GUIDE



SECTION 4

EO C422.01 – LOCATE A GEOCACHE

Total Time:

30 min

PREPARATION

PRE-LESSON INSTRUCTIONS

Resources needed for the delivery of this lesson are listed in the lesson specification located in A-CR-CCP-704/PG-001, *Gold Star Qualification Standard and Plan*, Chapter 4. Specific uses for said resources are identified throughout the instructional guide within the TP for which they are required.

Review the lesson content and become familiar with the material prior to delivering the lesson.

Create four geocaches for cadets to locate. Record information about each geocache on the Geocache Information Form located at Attachment A and photocopy one for each group. This form will be provided to the cadets to assist them with locating geocaches.

For each geocache, place a number of small treasures and a geocache register inside a watertight storage vessel. Label each vessel and place it in the appropriate location.

The activity is developed using four geocaches. Each cadet shall have the opportunity to practice locating a geocache. Depending on the number of cadets, more geocaches may be required.

PRE-LESSON ASSIGNMENT

Nil.

APPROACH

An interactive lecture was chosen for TP 1 to introduce the cadets to geocaching.

A practical activity was chosen for TP 2 as it is an interactive way for the cadets to locate a geocache and increase their Global Positioning System (GPS) receiver navigation skills in a safe, controlled environment. This activity contributes to the development of navigation skills and knowledge in a fun and challenging setting.

INTRODUCTION

REVIEW

Nil.

OBJECTIVES

By the end of this lesson the cadet shall have located a geocache.

IMPORTANCE

Geocaching is an activity where an individual locates points and objects through given coordinates using a GPS and provided clues. This activity develops GPS receiver skills, and benefits the cadet by practicing moving from points of origin to intended destinations using a GPS receiver.

Teaching Point 1**Describe the sport of geocaching.**

Time: 5 min

Method: Interactive Lecture

GEOCACHING

The word geocaching is pronounced *GEE-oh-cash-ing* and comes from two separate words; geo, for geology and cache, which means a hidden store of goods or valuables. Geocaching is a worldwide activity where one person establishes a cache and posts its location for others to find. Participants load the coordinates of the cache into their GPS receiver, and then use it to find the cache.



The most common website for information about geocaching is www.geocaching.com. This website allows participants to locate geocaches or to report the location of new geocaches.

ORIGIN

Geocaching originated in May 2000 when the United States government turned off GPS selective availability (selective availability purposely degrades the accuracy of the GPS signal). At that point, civilian GPS receivers, that were formerly accurate to 90-m (300 feet), became accurate to 3–9 m (10–30 feet). This level of accuracy offered some new creative possibilities.

When accuracy was increased, the recreational user developed a hide-and-seek type game with a high-tech twist and treasure. An individual would find a location in some out-of-the way place, record its coordinates and leave a stash behind for another gamer to locate.

EQUIPMENT REQUIRED

A GPS receiver and cache coordinates are all that is required to geocache. Geocache coordinates define the location of a geocache. They can be found through friends and on the Internet. The following items will provide a geocacher with a more enjoyable experience:

Spare batteries. Geocaching depends on the use of a GPS receiver; the GPS receiver is powered by batteries. In the event a GPS receivers' batteries expire while in use, it is imperative that the geocacher have replacement batteries.

Map and compass. In the event the GPS receiver fails or the batteries go dead, the map and compass will serve as a backup tool for navigation. A map will also provide the navigator with a detailed view of the landscape. Not all GPS receivers provide enough detail to effectively understand contours and terrain.

Pen or pencil and paper. Used for taking notes about the route and to leave notes in the cache.

An item to leave in the cache. Most caches have treasures left for individuals to find. The best items are unique, out-of-the-ordinary items (eg, foreign coins, fossils, exotic matchbooks, or anything that is attractive to a collector). Once an individual has located a cache they take a treasure and replace it with one of their own.

Appropriate clothes and footwear. Geocaching can have the navigator crossing various types of terrain in many different conditions. A geocacher should wear clothing suitable to stay warm and dry for the environmental conditions of the day and the terrain to be covered.

Food and water. Some caches take all day to find; it is important to be prepared with enough food and water to successfully complete the search.

Trekking pole or walking stick. If the terrain is rough, a good walking stick or set of trekking poles can make travelling up and down hills and negotiating uneven surfaces easier.

Flashlight. Can be used in order to see into cracks and crevices where a cache might be hidden. It also becomes useful if forced to travel in low light conditions.

Cellphone. In case contact with emergency services is required.

CONFIRMATION OF TEACHING POINT 1

QUESTIONS:

- Q1. What is geocaching?
- Q2. When did geocaching originate?
- Q3. What equipment is required to geocache?

ANTICIPATED ANSWERS:

- A1. Geocaching is a worldwide activity where one person establishes a cache and posts its location for others to find. Participants load the coordinates of the cache into their GPS receiver, and then use it to find the cache.
- A2. Geocaching originated in May 2000.
- A3. A GPS receiver and geocache coordinates are all that is required to geocache.

Teaching Point 2

Have the cadets, in groups of three, locate a geocache.

Time: 20 min

Method: Practical Activity

ACTIVITY

OBJECTIVE

The objective of this activity is to have the cadets, in groups of three, locate a geocache.

RESOURCES

- GPS receiver (one per group),
- Compass (one per group),
- Geocache coordinates,
- Topographical map of the local area (one per group), and
- Geocache treasures (eg, pencils, markers, erasers, shoe polish, instructions to properly tie parade boots).

ACTIVITY LAYOUT

Set up a round robin geocache hunt.

ACTIVITY INSTRUCTIONS

1. Divide the cadets into groups of three and provide each group with a GPS receiver.
2. Give each group the geocache coordinates.
3. Have each group choose a treasure item to place inside the geocache.
4. Have each group participate in a free-for-all (select geocaches of their own choice) style search by:
 - a. receiving all completed geocache information forms;
 - b. setting up the GPS receiver by:
 - (1) confirming that the correct coordinate system is set; and
 - (2) confirming the correct map datum is set;
 - c. creating a point of interest (POI) from a coordinate mark by:
 - (1) pressing MARK;
 - (2) moving the arrow joystick to highlight the location field;
 - (3) pressing ENTER;
 - (4) using the arrow joystick to adjust the characters in the first line (grid zone designation and 100 000-m square identification) of the location field;
 - (5) pressing ENTER to move to the second line of the location field;
 - (6) using the arrow joystick to adjust the characters in the second line (grid reference) of the location field;
 - (7) pressing ENTER;
 - (8) personalizing the POI, if desired;
 - (9) moving the arrow joystick to the save field; and
 - (10) pressing ENTER;
 - d. navigating to the geocache by:
 - (1) selecting a GOTO route;
 - (2) choosing the geocache POI;
 - (3) navigating to the area;
 - (4) searching the area of the POI for the geocache; and
 - (5) locating the geocache; and
 - e. swapping a treasure and obtaining the next geocache information form.
5. Have each group repeat Steps 4 b–e until they have located all four geocaches.

6. Conduct a debriefing by asking the cadets:
 - a. how they felt about the activity;
 - b. how they felt they worked together;
 - c. what portion of the activity challenged them the most;
 - d. how their teammates assisted them when they were challenged; and
 - e. if there are any specific examples of when their team experienced difficulty.

SAFETY

The possibility exists for cadets to become lost or disoriented while searching for a geocache. Establish boundaries, a stop time and a safety bearing before cadets participate in the activity.

CONFIRMATION OF TEACHING POINT 2

The cadets' participation in the geocache activity will serve as the confirmation of this TP.

END OF LESSON CONFIRMATION

The cadets' participation in the geocache activity will serve as the confirmation of this lesson.

CONCLUSION

HOMEWORK / READING / PRACTICE

Nil.

METHOD OF EVALUATION

Nil.

CLOSING STATEMENT

Participating in geocaching will develop a better working knowledge of how to use and navigate with a GPS receiver. The skills used in geocaching directly relate to expedition training and navigating with a GPS receiver.

INSTRUCTOR NOTES / REMARKS

The instructor is to create sample geocaches, select a location in the vicinity of the class, place the geocaches and mark the coordinates prior to conducting this lesson.

REFERENCES

C1-178 Thales Navigation Inc. (2004). *Magellan eXplorist 200 GPS user manual*. San Dimas, CA: Thales Navigation Inc.

C2-142 ISBN 0-7645-6933-3 McNamara, J. (2004). *GPS for dummies*. Hoboken, NJ: Wiley Publishing, Inc.

GEOCACHE INFORMATION FORM

| <p>Geocache Name:</p> <table border="1" style="width: 100%; border-collapse: collapse;"> <thead> <tr style="background-color: black; color: white;"> <th colspan="2" style="text-align: center;">GEOCACHE DETAILS</th> </tr> </thead> <tbody> <tr> <td style="width: 50%; text-align: center;">Coordinate System</td> <td style="text-align: center;">MGRS</td> </tr> <tr> <td style="text-align: center;">Grid Zone Designation</td> <td></td> </tr> <tr> <td style="text-align: center;">100 000-m Square Identification</td> <td></td> </tr> <tr> <td style="text-align: center;">Map Datum</td> <td></td> </tr> <tr> <td style="text-align: center;">Grid Reference Coordinates</td> <td></td> </tr> <tr> <td colspan="2" style="text-align: center;">Location Description / Hint</td> </tr> </tbody> </table> | GEOCACHE DETAILS | | Coordinate System | MGRS | Grid Zone Designation | | 100 000-m Square Identification | | Map Datum | | Grid Reference Coordinates | | Location Description / Hint | | <p>Geocache Name:</p> <table border="1" style="width: 100%; border-collapse: collapse;"> <thead> <tr style="background-color: black; color: white;"> <th colspan="2" style="text-align: center;">GEOCACHE DETAILS</th> </tr> </thead> <tbody> <tr> <td style="width: 50%; text-align: center;">Coordinate System</td> <td style="text-align: center;">MGRS</td> </tr> <tr> <td style="text-align: center;">Grid Zone Designation</td> <td></td> </tr> <tr> <td style="text-align: center;">100 000-m Square Identification</td> <td></td> </tr> <tr> <td style="text-align: center;">Map Datum</td> <td></td> </tr> <tr> <td style="text-align: center;">Grid Reference Coordinates</td> <td></td> </tr> <tr> <td colspan="2" style="text-align: center;">Location Description / Hint</td> </tr> </tbody> </table> | GEOCACHE DETAILS | | Coordinate System | MGRS | Grid Zone Designation | | 100 000-m Square Identification | | Map Datum | | Grid Reference Coordinates | | Location Description / Hint | |
|--|------------------|--|-------------------|------|-----------------------|--|---------------------------------|--|-----------|--|----------------------------|--|-----------------------------|--|--|------------------|--|-------------------|------|-----------------------|--|---------------------------------|--|-----------|--|----------------------------|--|-----------------------------|--|
| GEOCACHE DETAILS | | | | | | | | | | | | | | | | | | | | | | | | | | | | | |
| Coordinate System | MGRS | | | | | | | | | | | | | | | | | | | | | | | | | | | | |
| Grid Zone Designation | | | | | | | | | | | | | | | | | | | | | | | | | | | | | |
| 100 000-m Square Identification | | | | | | | | | | | | | | | | | | | | | | | | | | | | | |
| Map Datum | | | | | | | | | | | | | | | | | | | | | | | | | | | | | |
| Grid Reference Coordinates | | | | | | | | | | | | | | | | | | | | | | | | | | | | | |
| Location Description / Hint | | | | | | | | | | | | | | | | | | | | | | | | | | | | | |
| GEOCACHE DETAILS | | | | | | | | | | | | | | | | | | | | | | | | | | | | | |
| Coordinate System | MGRS | | | | | | | | | | | | | | | | | | | | | | | | | | | | |
| Grid Zone Designation | | | | | | | | | | | | | | | | | | | | | | | | | | | | | |
| 100 000-m Square Identification | | | | | | | | | | | | | | | | | | | | | | | | | | | | | |
| Map Datum | | | | | | | | | | | | | | | | | | | | | | | | | | | | | |
| Grid Reference Coordinates | | | | | | | | | | | | | | | | | | | | | | | | | | | | | |
| Location Description / Hint | | | | | | | | | | | | | | | | | | | | | | | | | | | | | |
| <p>Geocache Name:</p> <table border="1" style="width: 100%; border-collapse: collapse;"> <thead> <tr style="background-color: black; color: white;"> <th colspan="2" style="text-align: center;">GEOCACHE DETAILS</th> </tr> </thead> <tbody> <tr> <td style="width: 50%; text-align: center;">Coordinate System</td> <td style="text-align: center;">MGRS</td> </tr> <tr> <td style="text-align: center;">Grid Zone Designation</td> <td></td> </tr> <tr> <td style="text-align: center;">100 000-m Square Identification</td> <td></td> </tr> <tr> <td style="text-align: center;">Map Datum</td> <td></td> </tr> <tr> <td style="text-align: center;">Grid Reference Coordinates</td> <td></td> </tr> <tr> <td colspan="2" style="text-align: center;">Location Description / Hint</td> </tr> </tbody> </table> | GEOCACHE DETAILS | | Coordinate System | MGRS | Grid Zone Designation | | 100 000-m Square Identification | | Map Datum | | Grid Reference Coordinates | | Location Description / Hint | | <p>Geocache Name:</p> <table border="1" style="width: 100%; border-collapse: collapse;"> <thead> <tr style="background-color: black; color: white;"> <th colspan="2" style="text-align: center;">GEOCACHE DETAILS</th> </tr> </thead> <tbody> <tr> <td style="width: 50%; text-align: center;">Coordinate System</td> <td style="text-align: center;">MGRS</td> </tr> <tr> <td style="text-align: center;">Grid Zone Designation</td> <td></td> </tr> <tr> <td style="text-align: center;">100 000-m Square Identification</td> <td></td> </tr> <tr> <td style="text-align: center;">Map Datum</td> <td></td> </tr> <tr> <td style="text-align: center;">Grid Reference Coordinates</td> <td></td> </tr> <tr> <td colspan="2" style="text-align: center;">Location Description / Hint</td> </tr> </tbody> </table> | GEOCACHE DETAILS | | Coordinate System | MGRS | Grid Zone Designation | | 100 000-m Square Identification | | Map Datum | | Grid Reference Coordinates | | Location Description / Hint | |
| GEOCACHE DETAILS | | | | | | | | | | | | | | | | | | | | | | | | | | | | | |
| Coordinate System | MGRS | | | | | | | | | | | | | | | | | | | | | | | | | | | | |
| Grid Zone Designation | | | | | | | | | | | | | | | | | | | | | | | | | | | | | |
| 100 000-m Square Identification | | | | | | | | | | | | | | | | | | | | | | | | | | | | | |
| Map Datum | | | | | | | | | | | | | | | | | | | | | | | | | | | | | |
| Grid Reference Coordinates | | | | | | | | | | | | | | | | | | | | | | | | | | | | | |
| Location Description / Hint | | | | | | | | | | | | | | | | | | | | | | | | | | | | | |
| GEOCACHE DETAILS | | | | | | | | | | | | | | | | | | | | | | | | | | | | | |
| Coordinate System | MGRS | | | | | | | | | | | | | | | | | | | | | | | | | | | | |
| Grid Zone Designation | | | | | | | | | | | | | | | | | | | | | | | | | | | | | |
| 100 000-m Square Identification | | | | | | | | | | | | | | | | | | | | | | | | | | | | | |
| Map Datum | | | | | | | | | | | | | | | | | | | | | | | | | | | | | |
| Grid Reference Coordinates | | | | | | | | | | | | | | | | | | | | | | | | | | | | | |
| Location Description / Hint | | | | | | | | | | | | | | | | | | | | | | | | | | | | | |
| <p>Geocache Name:</p> <table border="1" style="width: 100%; border-collapse: collapse;"> <thead> <tr style="background-color: black; color: white;"> <th colspan="2" style="text-align: center;">GEOCACHE DETAILS</th> </tr> </thead> <tbody> <tr> <td style="width: 50%; text-align: center;">Coordinate System</td> <td style="text-align: center;">MGRS</td> </tr> <tr> <td style="text-align: center;">Grid Zone Designation</td> <td></td> </tr> <tr> <td style="text-align: center;">100 000-m Square Identification</td> <td></td> </tr> <tr> <td style="text-align: center;">Map Datum</td> <td></td> </tr> <tr> <td style="text-align: center;">Grid Reference Coordinates</td> <td></td> </tr> <tr> <td colspan="2" style="text-align: center;">Location Description / Hint</td> </tr> </tbody> </table> | GEOCACHE DETAILS | | Coordinate System | MGRS | Grid Zone Designation | | 100 000-m Square Identification | | Map Datum | | Grid Reference Coordinates | | Location Description / Hint | | <p>Geocache Name:</p> <table border="1" style="width: 100%; border-collapse: collapse;"> <thead> <tr style="background-color: black; color: white;"> <th colspan="2" style="text-align: center;">GEOCACHE DETAILS</th> </tr> </thead> <tbody> <tr> <td style="width: 50%; text-align: center;">Coordinate System</td> <td style="text-align: center;">MGRS</td> </tr> <tr> <td style="text-align: center;">Grid Zone Designation</td> <td></td> </tr> <tr> <td style="text-align: center;">100 000-m Square Identification</td> <td></td> </tr> <tr> <td style="text-align: center;">Map Datum</td> <td></td> </tr> <tr> <td style="text-align: center;">Grid Reference Coordinates</td> <td></td> </tr> <tr> <td colspan="2" style="text-align: center;">Location Description / Hint</td> </tr> </tbody> </table> | GEOCACHE DETAILS | | Coordinate System | MGRS | Grid Zone Designation | | 100 000-m Square Identification | | Map Datum | | Grid Reference Coordinates | | Location Description / Hint | |
| GEOCACHE DETAILS | | | | | | | | | | | | | | | | | | | | | | | | | | | | | |
| Coordinate System | MGRS | | | | | | | | | | | | | | | | | | | | | | | | | | | | |
| Grid Zone Designation | | | | | | | | | | | | | | | | | | | | | | | | | | | | | |
| 100 000-m Square Identification | | | | | | | | | | | | | | | | | | | | | | | | | | | | | |
| Map Datum | | | | | | | | | | | | | | | | | | | | | | | | | | | | | |
| Grid Reference Coordinates | | | | | | | | | | | | | | | | | | | | | | | | | | | | | |
| Location Description / Hint | | | | | | | | | | | | | | | | | | | | | | | | | | | | | |
| GEOCACHE DETAILS | | | | | | | | | | | | | | | | | | | | | | | | | | | | | |
| Coordinate System | MGRS | | | | | | | | | | | | | | | | | | | | | | | | | | | | |
| Grid Zone Designation | | | | | | | | | | | | | | | | | | | | | | | | | | | | | |
| 100 000-m Square Identification | | | | | | | | | | | | | | | | | | | | | | | | | | | | | |
| Map Datum | | | | | | | | | | | | | | | | | | | | | | | | | | | | | |
| Grid Reference Coordinates | | | | | | | | | | | | | | | | | | | | | | | | | | | | | |
| Location Description / Hint | | | | | | | | | | | | | | | | | | | | | | | | | | | | | |

THIS PAGE INTENTIONALLY LEFT BLANK



ROYAL CANADIAN ARMY CADETS
GOLD STAR
INSTRUCTIONAL GUIDE



SECTION 5

EO C422.02 – CREATE A GEOCACHE

Total Time: 30 min

PREPARATION

PRE-LESSON INSTRUCTIONS

Resources needed for the delivery of this lesson are listed in the lesson specification located in A-CR-CCP-704/PG-001, *Gold Star Qualification Standard and Plan*, Chapter 4. Specific uses for said resources are identified throughout the instructional guide within the TP for which they are required.

Review the lesson content and become familiar with the material prior to delivering the lesson.

Photocopy the Stash a Cache Record and Report Form located at Attachment A for each cadet.

Visit www.geocaching.com and print the information sheet of a geocache in the local area for use in TP 3.

PRE-LESSON ASSIGNMENT

Nil.

APPROACH

An interactive lecture was chosen for this lesson to introduce the cadet to creating a geocache.

INTRODUCTION

REVIEW

The review for this lesson is from EO C422.01 (Locate a Geocache).

QUESTIONS:

- Q1. What is geocaching?
- Q2. When did geocaching originate?
- Q3. What equipment is required to geocache?

ANTICIPATED ANSWERS:

- A1. Geocaching is a worldwide activity where one person establishes a cache and posts its location for others to find. Participants load the coordinates of the cache into their GPS receiver, and then use it to find the cache.
- A2. Geocaching originated in May 2000.
- A3. A GPS receiver and geocache coordinates are all that is required to geocache.

OBJECTIVES

By the end of this lesson the cadet shall be able to create a geocache.

IMPORTANCE

It is important for cadets to create a geocache. Cadets who participate in expeditions may come across unique places that they would consider a location many people would enjoy visiting. Being able to establish a geocache will allow others to seek out and find their unique location.

Teaching Point 1**Identify factors to consider when selecting a container to store a geocache.**

Time: 5 min

Method: Interactive Lecture

CHARACTERISTICS OF A GEOCACHE STORAGE CONTAINER

Creating a geocache requires careful planning. The geocache contains items that will have to be stored inside the container and must be able to withstand environmental conditions.

Durability

The type of container used to store a geocache should be based on the location. Considerations should include human traffic and environmental conditions, such as:

- deep cold,
- freezing,
- rapid thawing,
- rain, and
- extreme heat.



The contents of a geocache have to be protected from the environment in a waterproof container. Items can be placed inside a plastic bag within a container that is not waterproof but this is not recommended.

Size

Location can determine the size of a geocache. Urban geocaches are usually smaller, allowing the creator to hide them from the general passerby. Larger geocaches are generally placed in rural or wilderness locations. There is no set size of a geocache, but the standard that has been established reflects the following:

Micro. Tiny in size; roughly the size of a matchbox or 35-mm film canister.



Figure 1 Micro Key Chain Cache

Note. From "Shop Groundspeak," by Groundspeak, 2008, *Micro-Cache Capsule*. Copyright 2000–2008 by Groundspeak, Inc. Retrieved March 18, 2009, from <http://shop.groundspeak.com/productDetail.cfm?CategoryID=13&ProductID=47>

Small. Large enough to hold a small logbook; similar to the size of a small butter container (250–500 mL) or slightly larger.



Figure 2 Small Cache Stone

Note. From "Shop Groundspeak," by Groundspeak, 2008, *Small Cache Stone*. Copyright 2000–2008 by Groundspeak, Inc Retrieved March 18, 2009, from <http://shop.groundspeak.com/productDetail.cfm?CategoryID=13&ProductID=24>

Regular. Plastic storage containers and ammo boxes (30–50 cal) are considered regular size. They are able to store most items, large or small, and contain a large log book.



Figure 3 Pelican Cache Container–Medium

Note. From "Shop Groundspeak," by Groundspeak, 2008, *Pelican Cache Container–Medium*. Copyright 2000–2008 by Groundspeak, Inc. Retrieved March 18, 2009, from <http://shop.groundspeak.com/productDetail.cfm?CategoryID=13&ProductID=131>

Large. This container is the size of a 19-L (5-gallon) bucket or fuel can.

Colour

Containers can be any colour, but since the point of geocaching is to locate a hidden treasure, it is common to have the geocache coloured to blend in with the surrounding environment. Depending on the terrain and vegetation, olive and black are good colours for camouflage.



Figure 4 Geocache Container

Note. From "BB," by BBC, 2005, *Photo Galleries*. Retrieved March 17, 2009, from http://www.bbc.co.uk/wiltshire/content/image_galleries/wiltshire_05_year_in_pixs_gallery.shtml?6

CONTENTS OF A GEOCACHE

Visitor Register

Every geocache contains a visitor register or log. It allows people to record their success in finding the cache and leave a comment for others. The size of the cache will affect the size of the register. The register may be a small scroll or a large notebook. Some cache hidiers paste their logo or some other graphic on the cover of the visitor register.



When creating a geocache, seek approval from the unit commanding officer to place the corps crest or logo on the register. If one is not available, seek approval to use the Royal Canadian Army Cadets Corps (RCACC) Crest or the Canadian Cadet Movement (CCM) logo (as illustrated in Figures 5 and 6).



Figure 5 Sample Corps Crest

Note. Created by 2562 Queen Elizabeth Royal Canadian Army Cadet Corps. Retrieved March 17, 2009, from <http://2562army.zapto.org>



Figure 6 Royal Canadian Army Cadets Crest

Note. Created by Director Cadets 3, 2009, Ottawa, ON: Department of National Defence.



Figure 7 Cadets Canada

Note. Created by Director Cadets 3, 2009, Ottawa, ON: Department of National Defence.

Pen or Pencil

Allows other geocachers to write in the register about their discovery and share their experience with others. Pencils are the best option to place in the geocache as ink will freeze in the cold.

Trinkets or Treasures

These act as a reward for the visiting person. These items should be unique and interesting. They can include pins, medals, coins, pictures, etc. Geocaching is a family sport so put a mix of things that appeal to both young and old participants. There should be no need to continuously replace the trinkets, as geocachers should trade with the contents that have been initially placed in the cache. There is no specific requirement to fill the container with trinkets, but most caches have between 6–12 small items.

Resealable Plastic Bag

The container used should be waterproof but there is always the possibility the container may get damaged or left open. Store items that will be affected by moisture (eg, register, pen and treasures) inside the resealable bag.



If extra space is available inside the geocache container, include a few extra resealable bags in case the ones being used become damaged.

Identifying Information

The cache should have some information that identifies it as a geocache. There are two types of identifying information that can be found at a geocache:

Geocache information sheet. Describes what geocaching is and provides instructions to the finder (as illustrated in Figure 8). The geocaching.com website has this sheet available in a number of different languages. Laminating this sheet is a good idea. Be sure to record the geocache's name and its coordinates.

| <u>GEOCACHE SITE—PLEASE READ</u> |
|--|
| Geocache Name: _____ |
| Coordinates: _____ |
| Congratulations, you've found it! Intentionally or not! |
| What is this hidden container sitting here for? What the heck is this thing doing here with all these things in it? |
| It is part of a worldwide game dedicated to Global Positioning System (GPS) users, called Geocaching. The game basically involves a GPS user hiding "treasure" (this container and its contents), and publishing the exact coordinates so other GPS users can come on a "treasure hunt" to find it. The only rules are if you take something from the cache, you must leave something for the cache and you must write about your visit in the visitor register. Hopefully, the person who hid this container found a good spot that is not easily found by uninterested parties. Sometimes, a good spot turns out to be a bad spot, though. |
| IF YOU FOUND THIS CONTAINER BY ACCIDENT: |
| Great! You are welcome to join us! We ask: |
| <ul style="list-style-type: none"> • Please do not move or vandalize the container. The real treasure is just finding the container and sharing your thoughts with everyone else who finds it. • If you wish, go ahead and take something. But please also leave something of your own for others to find, and write it in the visitor register. • If possible, let us know that you found it, by visiting the website listed below. |
| Geocaching is open to everyone with a GPS and a sense of adventure. There are similar sites all over the world. The organization has its home on the Internet. Visit our website if you want to learn more, or have any comments: |
| http://www.geocaching.com |
| If this container needs to be removed for any reason, please let us know. We apologize, and will be happy to move it. |

Figure 8 Geocache Information Sheet

Note. Created by Director Cadets 3, 2009, Ottawa, ON: Department of National Defence.

Official geocache label. Identifies the container as a geocache. It provides the name of the geocache, contact name and contact information, (as illustrated in Figure 9). It is not required to place this information on the container, but it helps reduce the chances of someone thinking it may be dangerous. It should be placed on the outside of the container, and be visible and waterproof.



Geocaches registered with www.geocaching.com shall have an official geocaching label affixed to it. Contact information and the website with information pertaining to the geocache must be listed.



Figure 9 Official Geocache Label

Note. Created by Director Cadets 3, 2009, Ottawa, ON: Department of National Defence.

CONFIRMATION OF TEACHING POINT 1

QUESTIONS:

- Q1. What factors should be considered when selecting a geocache container?
- Q2. The size of a geocache container sets a limit on what?
- Q3. What are some of the items that can be place in a geocache?

ANTICIPATED ANSWERS:

- A1. The durability, size and colour are the factors that should be considered when selecting a geocache container.
- A2. The size of a geocache container limits the amount of items and treasures that can be placed in the container.
- A3. Items that can be placed in a geocache are:
 - visitor register,
 - pen or pencil,
 - trinkets or treasures,
 - resealable plastic bag, and
 - identifying information.

Teaching Point 2**Describe geocache locations.**

Time: 10 min

Method: Interactive Lecture

GEOCACHE LOCATIONS

A geocache location should offer a unique challenge or experience for the finder. What some might consider an easy cache might present exciting challenges for others. Guidelines exist when determining where geocaches should / should not be located.



The location of a cache defines its success and popularity; location is like marketing—make it appeal to people.

Locations a Geocache Should Be Placed

In the vicinity of a unique feature. Locating a place that has a unique feature will be interesting and attractive to geocachers.

In a location where there is incredible scenery or a gorgeous view. Geocachers enjoy visiting places that have a great view. Not every geocacher is going to look for a difficult challenge; searching for a scenic site with little difficulty will be just as rewarding to some.

In a location that provides a significant challenge. Geocaches that are challenging to find or difficult to get to are popular.

Locations a Geocache Should Not Be Placed

Underground. Covering a geocache with some leaves or branches is okay but burying a geocache is not acceptable. Geocaches are not to be dug up as if they were pirate booty.

Environmentally sensitive areas. Archaeological sites, historic sites and fragile environments are areas that have been deemed out of bounds and should not be disturbed.

National parks or designated wilderness areas. These areas are protected from human traffic. Placing a geocache here is not acceptable in the geocaching community.

Within 46 m (150 feet) of railroad tracks. For safety reasons, geocaches are not to be placed near railroads.

Anywhere that might cause concerns about possible terrorist activities. Since the terrorist attacks in the United States of America (USA), people have become wary of strange objects, containers, and cases. When selecting a site for a geocache, give consideration to what others, who are not playing the game, may think if they come across the cache. Try to avoid placing caches near, on or under public structures. These may include, but are not limited to highway bridges, dams, government buildings, elementary and secondary schools, and airports.

Within 160 m (one tenth of a mile) of another geocache. Placing a geocache in close proximity of another could become confusing over time. Research the location online to determine there is no other geocaches close by. This is geocaching etiquette.

CONFIRMATION OF TEACHING POINT 2

QUESTIONS:

- Q1. What makes a geocache attractive for others to visit?
- Q2. Where should geocaches not be placed?
- Q3. Why should geocaches not be placed near government buildings or public structures?

ANTICIPATED ANSWERS:

- A1. Geocachers like to find caches in locations that have some unique features or incredible scenery and that are challenging to navigate.
- A2. Geocaches should not be placed:
- underground,
 - in environmentally sensitive areas,
 - in national parks or designated wilderness areas,
 - within 46 m (150 feet) of railroad tracks,
 - anywhere that might cause concerns about possible terrorist activities, and
 - within 160 m (one-tenth of a mile) of another geocache.
- A3. People who do not understand the game may mistake a geocache for something dangerous.

Teaching Point 3

Identify how to submit a geocache to a website.

Time: 10 min

Method: Interactive Lecture

ACCESSING GEOCACHE WEBSITES

Search the Internet to locate websites that post geocaches. There is no cost associated with most geocache websites. Websites have rules and guidelines to follow when submitting a geocache.



The website www.geocaching.com is one of the most popular geocaching websites.

REGISTERING THE GEOCACHE BY SUBMITTING THE GEOCACHE INFORMATION



Distribute the Stash a Cache Record & Report Form located at Attachment A to each cadet. This is the information a website requires to post a geocache.

Show the cadets the information sheet of the geocache in the local area printed from www.geocaching.com

Log on to a website and begin the process for submitting a cache. The site should guide cadets through the process with an online form about the geocache. The contents of the form will vary from site to site; however, the information below is some of the common information that would be submitted when posting a geocache.

Geocache type. There are many types of geocaches, including traditional (a single container), multi-cache (clues to one or more other caches in a single cache point), virtual (a location that does not have a container), and letterbox (clues are listed instead of coordinates). When submitting information, the type of geocache will have to be identified.

Geocache size. Can be from a micro size (35-mm film canister) to a large size (19-L bucket). Reference the website form and select the size of the geocache.

Nickname. The name of the geocache.

Date placed. Commonly written as mm/dd/yyyy.

Coordinates. The standard system used is latitude and longitude.



When inputting latitude and longitude coordinates and switching to Military Grid Reference System (MGRS), the original coordinates will automatically change.

Location. Lists the province and country.

Difficulty rating. Typically based on a scale from one to five: one being easy and five being hard. The scale is often developed by the host website; when filling out this information, consult their rating system.

Terrain rating. Typically based on a scale from one to five: one being easy and five being hard. The scale is often developed by the host website; when filling out this information, consult their rating system.

Short description. Provides the geocacher with location information, such as terrain, general difficulty levels, and altitudes.

Long description. Provides details about the geocache, including contents and what the container looks like.

Trackable items. These items are placed as treasures. The requirement of the finder is to report online back to the creator of the geocache, and comment that they have located their trackable treasure and will follow up when they place the item in another geocache. The item will continue to get tracked as it is passed from geocache to geocache.

MAINTAINING THE GEOCACHE

Servicing a Geocache

Once a geocache has been established it becomes the responsibility of the creator to maintain the cache. This means visiting the cache periodically to verify that it is still there and in the same condition. The cache may need to be resupplied with little trinkets and treasures. If the site seems like it is being disturbed or damaged, consider moving the geocache or removing the geocache entirely. If one determines they no longer want to manage the geocache, it must be entirely removed from the location and the website.

Overseeing Posted Blogs

The geocache created will hopefully be visited by many people. By registering the geocache online, the website(s) will allow visitors to submit a blog (small note) on the geocache visited. It is the responsibility of the geocache creator to ensure the blogs posted are legitimate and to determine if the entry is a true or false report.

CONFIRMATION OF TEACHING POINT 3**QUESTIONS:**

- Q1. What website is the most popular website for geocaching?
- Q2. What does the scale of terrain difficulty explain?
- Q3. Who is responsible to maintain a geocache?

ANTICIPATED ANSWERS:

- A1. The most popular website for geocaching is www.geocaching.com
- A2. The scale of terrain difficulty describes the rating system used to determine how difficult the terrain is when traveling to the geocache; one being easy and five being hard.
- A3. The creator of the geocache is responsible to maintain it.

END OF LESSON CONFIRMATION**QUESTIONS:**

- Q1. What website is the most popular website for geocaching?
- Q2. What kinds of items are located inside a geocache?
- Q3. In what type of coordinates would a geocache usually be recorded?

ANTICIPATED ANSWERS:

- A1. The most popular website for geocaching is www.geocaching.com
- A2. The items placed in a geocache should be unique and interesting. They can include pins, medals, coins, and pictures.
- A3. The coordinates would usually be recorded in latitude and longitude.

CONCLUSION

HOMEWORK / READING / PRACTICE

Nil.

METHOD OF EVALUATION

Nil.

CLOSING STATEMENT

GPS technology is a very accurate way to navigate from point to point. Geocaching is one of the fastest ways to get real-world experience with a GPS receiver. This sport is a fun and challenging activity that combines modern technologies with outdoor navigation skills.

INSTRUCTOR NOTES / REMARKS

Print a list of local geocaches from a website (eg, www.geocaching.com) illustrating the information from an established geocache.

EO C422.01 (Locate a Geocache) shall be completed prior to conducting this lesson.

Time has not been allocated during this lesson for the cadets to create a geocache. A geocaching activity has been developed as an option in EO C422.06 (Practice Navigation as a Member of a Small Group). Corps are strongly encouraged to use these complementary periods to create and locate geocaches.

REFERENCES

C2-142 ISBN 0-7645-6933-3 McNamara, J. (2004). *GPS for dummies*. Hoboken, NJ: Wiley Publishing, Inc.

Stash a Cache Record and Report Form

| | |
|----------------------|--------------------------------------|
| GEOCACHE TYPE | |
| | eg, Traditional, Multi or Letterbox. |
| GEOCACHE SIZE | |
| | eg, Micro, Small, Regular or Large. |

| | |
|-----------------|--|
| NICKNAME | |
|-----------------|--|

| | |
|---|--|
| DATE PLACED <small>MM/DD/YYYY</small> | |
|---|--|

| | | |
|--------------------|---|--|
| COORDINATES | Latitude & Longitude Degrees and Minutes N _____ ° _____` W _____ ° _____` | MGRS Grid Zone Designator _____ 100 000-m Square Identifier _____ 10-Figure GR: E _____ N _____ |
|--------------------|---|--|

| | |
|-----------------|--|
| LOCATION | |
|-----------------|--|

| | | | | | | | | | |
|---|---|-----|---|-----|---|-----|---|-----|---|
| DIFFICULTY RATING <small>(select one)</small> | 1 | 1.5 | 2 | 2.5 | 3 | 3.5 | 4 | 4.5 | 5 |
| TERRAIN RATING <small>(select one)</small> | 1 | 1.5 | 2 | 2.5 | 3 | 3.5 | 4 | 4.5 | 5 |

| | |
|--------------------------|--|
| SHORT DESCRIPTION | <small>Provide the geocacher with location information, such as terrain, general difficulty levels and altitudes.</small> <div style="border: 1px solid black; height: 40px; width: 100%;"></div> |
|--------------------------|--|

| | |
|-------------------------|---|
| LONG DESCRIPTION | <small>Provide details about the cache, including contents of the cache and what the container looks like.</small> <div style="border: 1px solid black; height: 60px; width: 100%;"></div> |
|-------------------------|---|

THIS PAGE INTENTIONALLY LEFT BLANK



ROYAL CANADIAN ARMY CADETS

GOLD STAR

INSTRUCTIONAL GUIDE



SECTION 6

EO C422.03 – DISCUSS MAP SOFTWARE

Total Time:

30 min

PREPARATION

PRE-LESSON INSTRUCTIONS

Resources needed for the delivery of this lesson are listed in the lesson specification located in A-CR-CCP-704/PG-001, *Gold Star Qualification Standard and Plan*, Chapter 4. Specific uses for said resources are identified throughout the instructional guide within the TP for which they are required.

Review the lesson content and become familiar with the material prior to delivering the lesson.

If available, provide an example using a global positioning system (GPS) receiver that is capable of connecting with a computer complete with the manufacturer's software.

If the resources are available, connect to the Internet and access Google Earth. Provide a simulation on how to upload information from a GPS receiver to Google Earth.

PRE-LESSON ASSIGNMENT

Nil.

APPROACH

An interactive lecture was chosen for this lesson to introduce the cadet to map software for GPS receivers.

INTRODUCTION

REVIEW

Nil.

OBJECTIVES

By the end of this lesson the cadet shall have discussed map software.

IMPORTANCE

It is important for cadets to know that map software is available and GPS receiver units are capable of networking with a computer and web-based software. The combination of map software and GPS receivers has the ability to enhance planning and tracking capabilities. Cadets can plan their route on a computer, review their route with more detail, print usable maps and download prepared routes with waypoints and points of interest (POIs). The ability to perform these functions may allow the cadet to plan and design the navigation component of a day hike or expedition with meticulous scrutiny.

Teaching Point 1**Describe GPS manufacturer software features.**

Time: 15 min

Method: Interactive Lecture

SOFTWARE FEATURES

GPS receiver manufacturers have developed a number of software products that allow the user to access the GPS receiver's map on a computer. The ability to work with the map on a computer allows the cadet to plan and prepare routes and study the terrain along the route.

Every GPS receiver's make and model is typically sold with a different base map (preloaded map that comes with the purchase of a GPS receiver). These maps can be added to commercially available maps / software to upload a different map. This allows new and improvised benefits like increased detail, different styles of maps (eg, topographical, nautical) or updated maps.



Different manufacturers' GPS receivers are similar, but have specific differences that separate one from the other.

The following points identify a GPS receiver's software functions when connected to a computer. Most GPS receivers have these common features:

Setting POIs. Software packages have POIs such as restaurants, stations and geographic features shown on the maps that may be viewed with a computer or GPS receiver. These POIs can be set while using the computer and later downloaded to the receiver for use while travelling along the planned route.

Printing maps on a personal computer. The maps from a GPS receiver with the manufacturer's computer software allow the user to view and print maps, measure distances, and plan trips. The ability to print the map provides a hard copy of the planned route, reducing the requirement to purchase additional maps of the area.

Uploading maps, waypoints, routes and tracks to GPS receivers. One purpose of mapping programs is to upload maps to the GPS receiver. The maps appear in colour and are the same on the computer and the GPS receiver screen, although the GPS receiver displays smaller portions of the map compared to the computer screen. Once a map is uploaded to the computer, waypoints, routes, and tracks can be uploaded from the computer to a GPS receiver. The user can plot several waypoint locations on the computer map and then transfer them to the GPS receiver.

Downloading GPS receiver data to a personal computer. With GPS mapping software, information that has been recorded with the GPS receiver, such as waypoints, routes, and tracks, can be downloaded. This data can then be viewed as an overlay on the maps displayed on the computer or stored on the computer's hard drive for future reference.

CONFIRMATION OF TEACHING POINT 1**QUESTIONS:**

- Q1. What common software features are available for computers and GPS receivers?
- Q2. What is the benefit of having the ability to print a map from the computer GPS receiver software?
- Q3. What information can be downloaded from a GPS receiver to a computer?

ANTICIPATED ANSWERS:

- A1. The common software features available for computers and GPS receivers are options that allow the users to:
- set POIs;
 - print maps on a computer;
 - upload maps, waypoints, routes and tracks to GPS receivers; and
 - download GPS receiver data to a personal computer.
- A2. The ability to print the map gives the user a hard copy of the planned route, reducing the requirement to purchase additional maps of the area.
- A3. The information that has been recorded with the GPS receiver, such as waypoints, routes, and tracks, can be downloaded. This data can then be viewed as an overlay on the maps displayed on the computer or stored on the computer's hard drive for future reference.

Teaching Point 2**Describe web-based resources.**

Time: 10 min

Method: Interactive Lecture

WEB-BASED RESOURCES

During this TP explain to the cadets how GPS receivers are now being used for many different purposes other than navigation. Allow the cadets to comment and express their experiences and ideas to help develop and support the information presented.

GPS receivers are used for more than just navigation. Entrepreneurs have developed many ways to use a GPS receiver to help with tracking, locating, measuring, and positioning. These applications are available through the Internet.

The Internet provides the GPS receiver user with many sites where they can access and upload their treks. Google Earth is a program provided free by Google (www.google.com) that allows the GPS receiver user to link with the program and upload their trekking history, including start and finish locations, waypoints and POIs. This program then maps out the trek and displays it on a overlay of the map provided by the program. The program is also capable of providing real-time tracking.



Information that is uploaded is surrendered to the website and the data then becomes available for anyone to view and use.

This is just one example of a web-based resource that is available to GPS receiver users. Other web-based resources can be used for:

- pet and animal tracking,
- personal safety locators and trackers,
- theft deterrence devices for automotive vehicles,
- cell phone tracking,

- child monitoring and communications, and
- athletic training tracking.

CONFIRMATION OF TEACHING POINT 2

QUESTIONS:

- Q1. What other websites exist for GPS users?
- Q2. What can a GPS receiver user do when they access the program Google Earth?
- Q3. What other web-based resources exist for GPS receiver users?

ANTICIPATED ANSWERS:

- A1. The answers provided will be based on the cadets' experience with web-based resources.
- A2. A GPS receiver user can upload their trekking history, including start and finish location, waypoints and POIs. Google Earth maps out the trek and displays it on a overlay of the map provided by the program. The site is also capable of providing real time tracking.
- A3. The other web-based resources can be used for:
- pet and animal tracking,
 - personal safety locators and trackers,
 - theft deterrence devices for automotive vehicles,
 - cell phone tracking,
 - child monitoring and communications, and
 - athletic training tracking.

END OF LESSON CONFIRMATION

QUESTIONS:

- Q1. What are three software features of GPS receiver manufacturer software for computers?
- Q2. What is the main purpose of mapping programs on a computer?
- Q3. What website can be used to interface with a GPS receiver and provide an overlay of a persons trek?

ANTICIPATED ANSWERS:

- A1. Three features of GPS receiver manufacturer software for computers can include any of the following:
- set POIs,
 - print maps on a computer,
 - upload maps, waypoints, routes and tracks to GPS receivers, and
 - download GPS receiver data to a computer.

- A2. The main purpose of mapping programs on a computer is to upload maps to the GPS receiver.
- A3. Google Earth can interface with a GPS receiver.

CONCLUSION

HOMEWORK / READING / PRACTICE

Nil.

METHOD OF EVALUATION

Nil.

CLOSING STATEMENT

GPS receivers have many capabilities. Cadets are able to access the Internet and link the GPS receiver with the computer, uploading information from the GPS receiver to obtain a visual representation and description of the areas travelled. This information can be shared with other cadets who wish to retrace a route that someone has already travelled.

INSTRUCTOR NOTES / REMARKS

Nil.

REFERENCES

C2-142 ISBN 0-7645-6933-3 McNamara, J. (2004). *GPS for dummies*. Hoboken, NJ: Wiley Publishing, Inc.

THIS PAGE INTENTIONALLY LEFT BLANK



ROYAL CANADIAN ARMY CADETS

GOLD STAR

INSTRUCTIONAL GUIDE



SECTION 7

EO C422.04 – MEASURE A GRID BEARING WITH A PROTRACTOR

| | |
|-------------|--------|
| Total Time: | 90 min |
|-------------|--------|

PREPARATION

PRE-LESSON INSTRUCTIONS

Resources needed for the delivery of this lesson are listed in the lesson specification located in A-CR-CCP-704/PG-001, *Gold Star Qualification Standard and Plan*, Chapter 4. Specific uses for said resources are identified throughout the instructional guide within the TP for which they are required.

Review the lesson content and become familiar with the material prior to delivering the lesson.

Photocopy the Steps to Measure a Grid Bearing With a Protractor handout located at Attachment A for each cadet.

Photocopy the Steps to Converting Bearings located at Attachment B for each cadet.

Prepare the topographical map of the area being used. A minimum of four sets of six-figure grid references (GRs) for the start and finish points.

Identify a minimum of four grid bearings and four magnetic bearings to convert.

For the activity in TP 3, select a location, such as a sports field or park, where cadets can march on a bearing for at least 100 paces. From the start point, take a bearing that will allow cadets to march no less than 100 paces in a straight line with the magnetic declination of the compass set at zero, 10° mils west and 10° mils east, safely and within visibility of the start point.

Assistant instructors may be required for this lesson.

PRE-LESSON ASSIGNMENT

Nil.

APPROACH

An interactive lecture was chosen for TP 1 to introduce the cadet to the features of a protractor.

A demonstration and performance was chosen for TPs 2 and 3 as it allows the instructor to explain and demonstrate the skill of measuring grid bearings with a protractor and converting bearings while providing an opportunity for the cadet to practice the skill under supervision.

A practical activity was chosen for TP 4 as it is an interactive way to allow cadets to experience following a magnetic bearing in a safe and controlled environment.

INTRODUCTION

REVIEW

Nil.

OBJECTIVES

By the end of this lesson the cadet shall have measured a grid bearing with a protractor.

IMPORTANCE

It is important for cadets to know how to measure a grid bearing with a protractor as it is much more accurate than the compass when measuring grid bearings and it provides the cadet an opportunity to enhance their map and compass skills by using another useful navigation tool.

Teaching Point 1**Describe the features of a protractor.**

Time: 10 min

Method: Interactive Lecture



This TP is to describe the features of the protractor to the cadets. Distribute a protractor to every cadet so they can clearly see each feature and point to each feature as it is described.

Refer to Figure 1 to aid in locating and describing the features of the protractor.

FEATURES OF A PROTRACTOR

The protractor is made of flexible plastic. Its features include:

1. 1 : 50 000 scale romer,
2. 1 : 25 000 scale romer,
3. a hole in each romer for plotting GRs,
4. conversion scale for converting between mils and degrees,
5. graduations in mils (outside edge),
6. graduations in degrees (outside edge),
7. 1 : 50 000 scale for measuring distance,
8. 1 : 25 000 scale for measuring distance,
9. centre lines (vertical and horizontal),
10. a centre hole, and
11. conversion scales for converting units of distance.



The outside of the protractor indicates both degrees and mils.

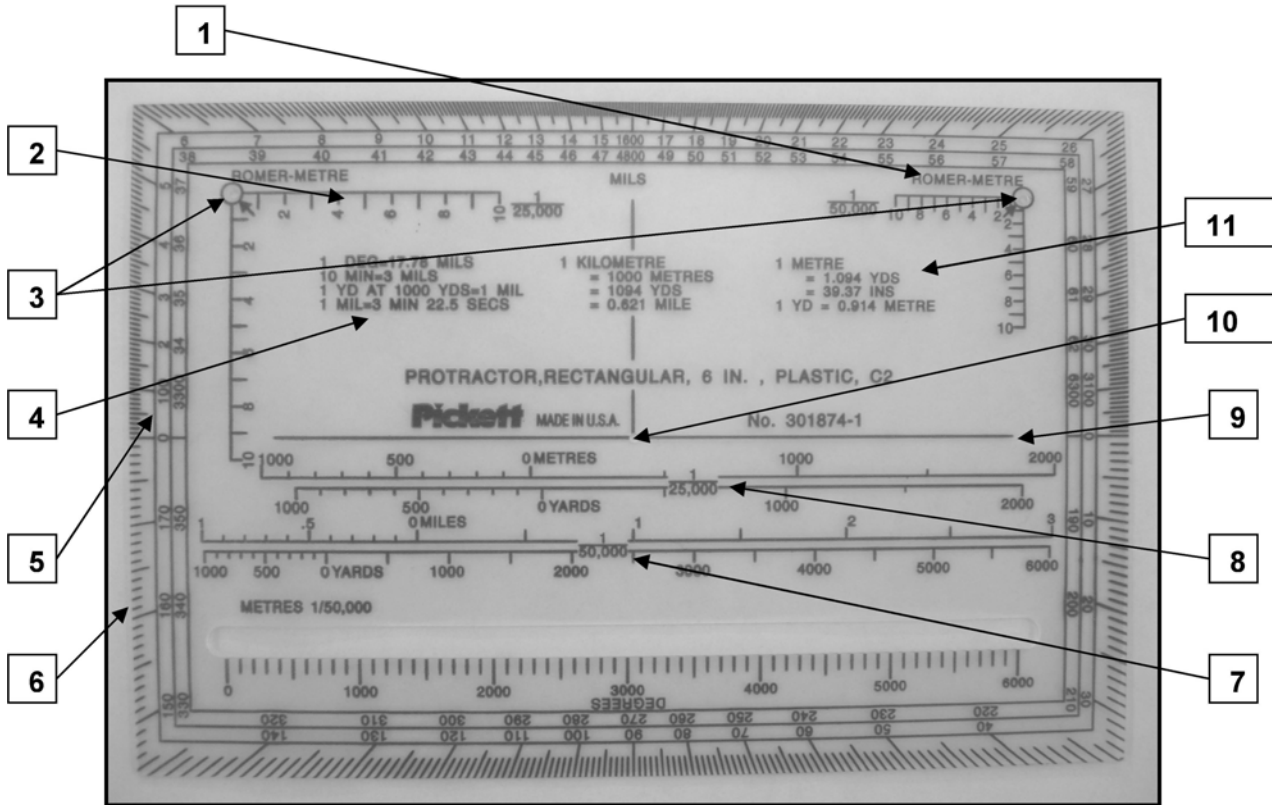

Figure 1 Protractor

Note. Created by Director Cadets 3, 2009, Ottawa, ON: Department of National Defence.

CONFIRMATION OF TEACHING POINT 1

QUESTIONS:

- Q1. What is the protractor made of?
- Q2. How many romers are there on the protractor and where are they located?
- Q3. What do the graduations around the outside edge of the protractor show?

ANTICIPATED ANSWERS:

- A1. The protractor is made of flexible plastic.
- A2. There are two romers: 1 : 25 000 and 1 : 50 000 scale, located at the top left and right hand corners.
- A3. The graduations are in mils and degrees.

Teaching Point 2**Explain, demonstrate and have the cadets measure a grid bearing with a protractor.**

Time: 20 min

Method: Demonstration and Performance



For this skill TP, it is recommended that instruction take the following format:

1. Explain and demonstrate the complete skill of how to measure a grid bearing with a protractor while cadets observe, to include:
 - a. plotting the six-figure GR start and finish points;
 - b. placing the protractor on the map;
 - c. aligning the protractor parallel to the eastings; and
 - d. reading the grid bearing at the point where the plotting ray crosses the edge of the protractor.
2. Explain and demonstrate each step required to measure a grid bearing with a protractor.
3. Have each cadet practice each step.
4. Have each cadet perform the complete skill.

Distribute a copy of the Steps to Measure a Grid Bearing with a Protractor handout located at Attachment A for each cadet, as a reference.

MEASURE A GRID BEARING WITH A PROTRACTOR

The steps to measuring a grid bearing with a protractor are:

Step 1. Plot the six-figure GR start and finish points by:

- sharpening the pencil that is being used, as this will allow for a more accurate plotting of a bearing;



The line of the plotting ray that is created must be accurate and thin. If the plotting ray is slightly off or thick, it can cause the bearing reading to be off, which can cause the final location to be missed by the navigator.

- identifying, using a romer to create a precise dot, the start GR and marking it as Point A on the map;
- identifying, using a romer to create a precise dot, the finish GR and marking it as Point B on the map;
- drawing a straight line, using the edge of the protractor, starting from Point A and continuing to Point B (This line is called the plotting ray); and
- extending the plotting ray past Point A and B and mark the line with an arrow to indicate the direction of travel. This will make it easier to read the bearing.



The plotting and reading of grid bearings on a map can be done by using either a protractor or a compass; however, the protractor is a more accurate measure.



Figure 2 Step 1 to Measuring a Grid Bearing With a Protractor

Note. Created by Director Cadets 3, 2009, Ottawa, ON: Department of National Defence.

Step 2. Place the protractor on the map by:

- ensuring the centre hole is on the plotting ray and the centre line is over an easting line on the map;
- orienting zero mils to the top of the map (north); and
- ensuring the mils scale is placed east or west of the grid lines, as required.



If the bearing to be plotted is estimated to be between 0 and 3 200 mils, the protractor must be placed so that the mils scale is to the east of the easting line.

If the bearing to be plotted is estimated to be between 3 200 mils and 6 400 mils, the protractor must be placed so that the mils scale is to the west of the easting line.

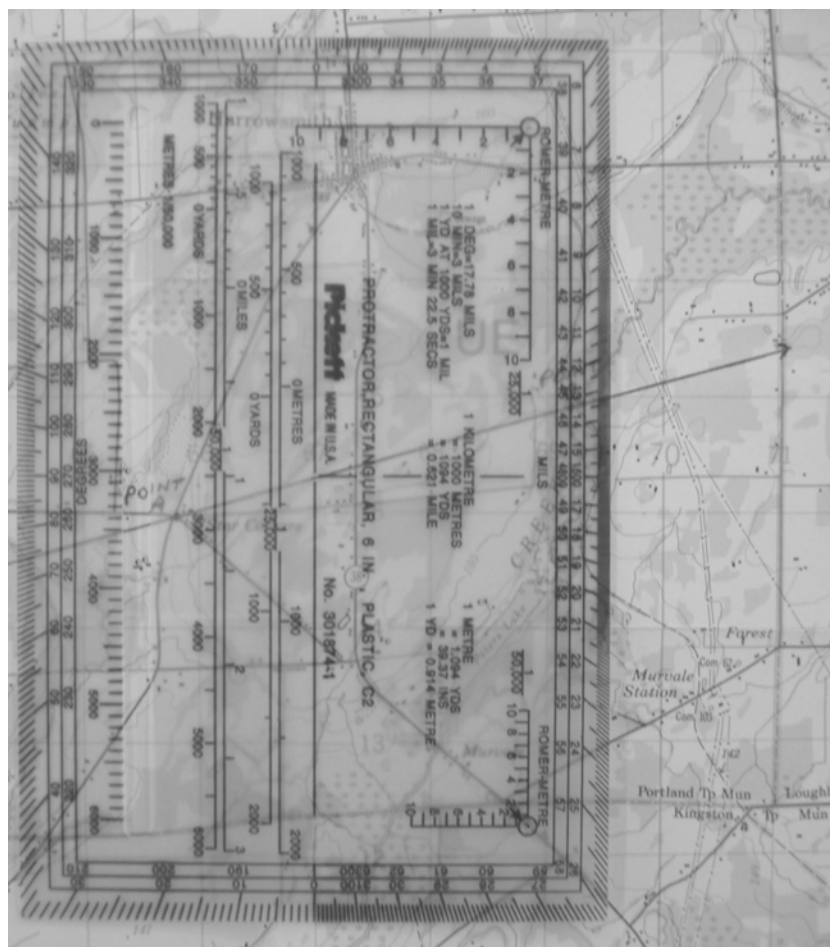

Figure 3 Step 2 to Measuring a Grid Bearing With a Protractor

Note. Created by Director Cadets 3, 2009, Ottawa, ON: Department of National Defence.

Step 3. Align the protractor parallel to the eastings by:

- sliding the centre hole along the plotting ray; and
- matching the vertical line on the protractor with an easting line.

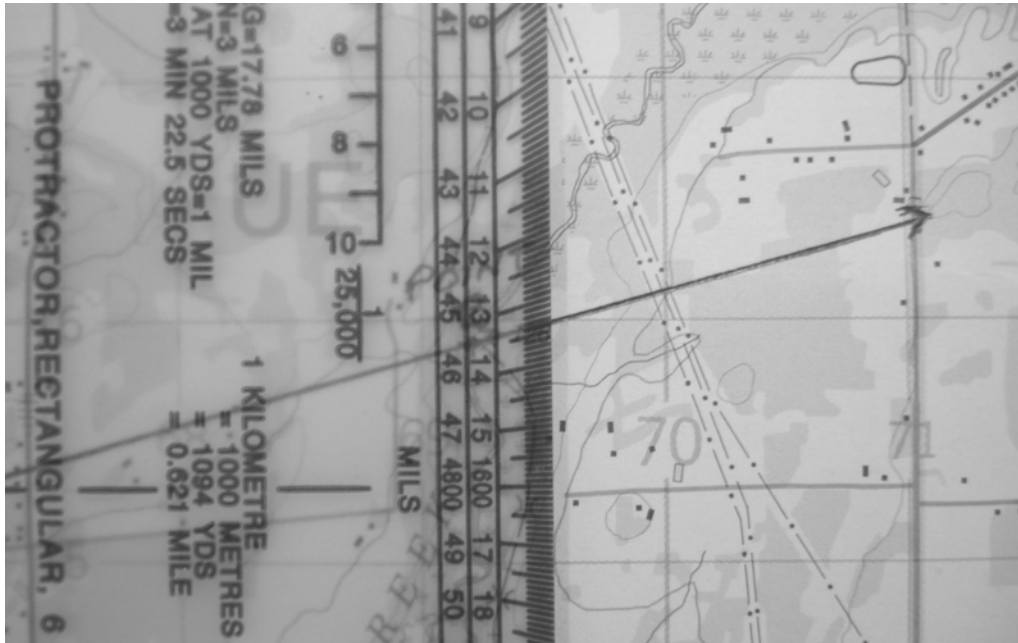

Figure 4 Step 3 to Measuring a Grid Bearing With a Protractor

Note. Created by Director Cadets 3, 2009, Ottawa, ON: Department of National Defence.

Step 4. Read the grid bearing at the point where the plotting ray crosses through the mils graduations on the side of the protractor by:

- finding and reading the grid bearing off the protractor on the mils scale;
- determining which bearing is the correct one; and
- recording the bearing.



By referring to basic knowledge of cardinal points and their mils equivalents, a close estimate of the bearing can be determined prior to plotting and reading the grid bearing.

CONFIRMATION OF TEACHING POINT 2

The cadets' measuring a grid bearing with a protractor will serve as the confirmation of this TP.

Teaching Point 3

Conduct an activity where the cadets will demonstrate the effects of magnetic declination adjustment.

Time: 30 min

Method: Practical Activity

The magnetic declination correctly set on a compass will help to identify the bearing from one's current location to a prominent object, which will save hours when in the wilderness.



The term magnetic declination is correctly used to identify the difference between true north (axis of the earth) and magnetic north (compass). Because the army rarely uses true north for land navigation, it is common to refer to the difference between grid north (map) and magnetic north (compass), the grid magnetic angle, as magnetic declination.

Magnetic declination is the difference between grid north (map) and magnetic north (compass). It is caused by the different locations of the north of the eastings and the magnetic north pole.

Declination changes due to the constantly shifting magnetic pole. Although this change is ongoing, the variation is minor, therefore only the annual change (change over the course of one calendar year) is calculated.



Where it is necessary to convert from degrees to mils or vice versa when following a bearing, the following conversion factors may be useful.

- $1^\circ = 17.8$ mils;
- $1' = 0.3$ mils;
- $1 \text{ mil} = 3.4'$

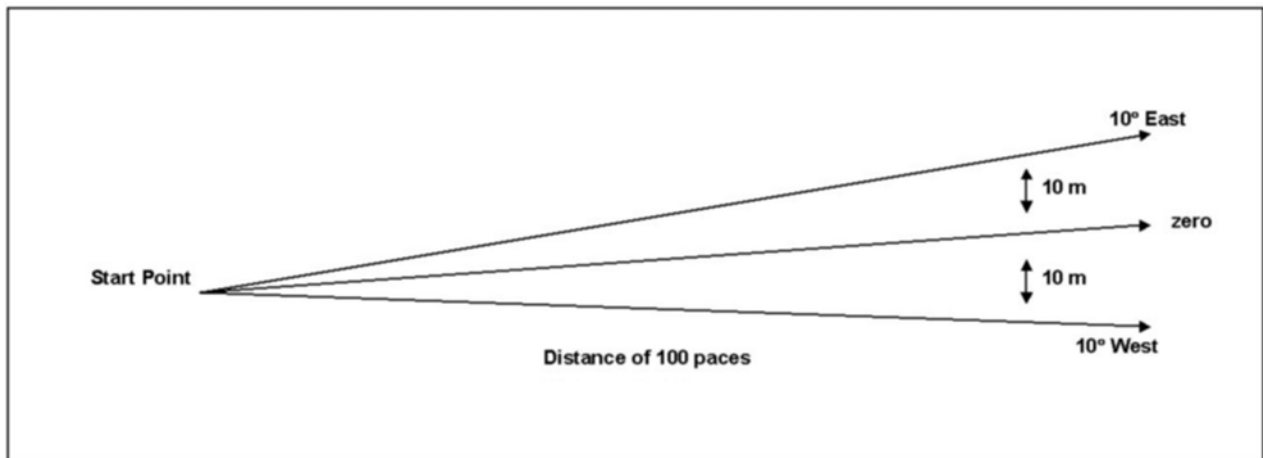

Figure 5 Following a Magnetic Bearing Description

Note. Created by Director Cadets 3, 2009, Ottawa, ON: Department of National Defence.

ACTIVITY

Time: 25 min

OBJECTIVE

The objective of this activity is to have the cadets demonstrate the effects of magnetic declination by following three different magnetic bearings to determine the importance of calculating the correct magnetic declination on a compass.

RESOURCES

- Topographical map (one per cadet),
- Compass (one per cadet),

- Marker, with flag (one per cadet),
- A predetermined distance, and
- Predetermined magnetic declinations.

ACTIVITY LAYOUT

Nil.

ACTIVITY INSTRUCTIONS

1. Conduct a safety briefing.
2. Select three cadets to march on the bearings.
3. Issue each cadet the required resources.
4. Have one cadet follow a bearing for 100 paces with the magnetic declination on the compass set to zero.
5. Have a cadet follow a bearing for 100 paces with the magnetic declination on the compass set to 10 degrees east.
6. Have a cadet follow a bearing for 100 paces with the magnetic declination on the compass set to 10 degrees west.
7. Once the three cadets have marched 100 paces, have them stop and mark the spot with a flagged marker that is visible from a distance and return to the start point.
8. From the start point, have the cadets observe the three points and note the difference. Also inform them that if the cadets were to keep walking, the further they are from the start point, the further apart they would become.



This activity demonstrates that an incorrect magnetic declination set on a compass can affect the final destination when following a bearing.

9. Conduct a debriefing.

SAFETY

Cadets shall be briefed on boundaries.

CONFIRMATION OF TEACHING POINT 3

The cadets' participation in demonstrating the effects of magnetic declination when following a magnetic bearing will serve as the confirmation of this TP.

Teaching Point 4**Explain, demonstrate and have the cadets convert bearings.**

Time: 20 min

Method: Demonstration and Performance



For this skill TP it is recommended that instruction take the following format:

1. Explain and demonstrate the complete skill of how to measure a grid bearing with a protractor while cadets observe, to include:
 - a. identifying the grid or magnetic bearing;
 - b. converting the bearing; and
 - c. listing the magnetic or grid bearing.
2. Explain and demonstrate each step required to convert bearings.
3. Have each cadet practice each step.
4. Have each cadet practice the complete skill.

Distribute a copy of the Steps to Converting Bearings handout located at Attachment B for each cadet, as a reference.

Refer to A-CR-CCP-703/PF-001, *Silver Star Instructional Guides*, EO M322.02 (Calculate Magnetic Declination), if further information is required.

Use the pre-determined grid bearings and magnetic bearings when converting.

CONVERT BEARINGS

Bearings taken on a map are grid bearings and bearings taken using a compass to an object on the ground are magnetic bearings. Given the fixed point of reference for these two types of bearings, north, is not the same for grid bearings (map north located at the top of the eastings) and magnetic bearings (magnetic north), there is a requirement to convert the bearings when switching from using a map to using a compass. Some compasses will do this automatically when the magnetic declination is set on the compass. When using compasses without the magnetic declination set or a protractor the bearing will have to be manually converted.

Map users will identify the declination in the marginal information through a declination diagram depicting the true, grid, and magnetic bearing of any line within the area of the map sheet.

The steps to converting a grid bearing to a magnetic bearing are:

1. Calculate the current magnetic declination.
2. Adjust for the magnetic bearing by either adding or subtracting the appropriate angle, which is called the grid magnetic angle (GMA), to / from the grid bearing.



When converting grid bearings to magnetic bearings, the following mathematical formulas are used:

- When the GMA is **west** of Grid North, **add** the magnetic declination to the grid bearing (west is best).
- When the GMA is **east** of Grid North, **subtract** the magnetic declination from the grid bearing (east is least).



Grid magnetic angle is the horizontal angular difference between grid north and magnetic north. This is the number that is applied when converting from magnetic to grid bearings.

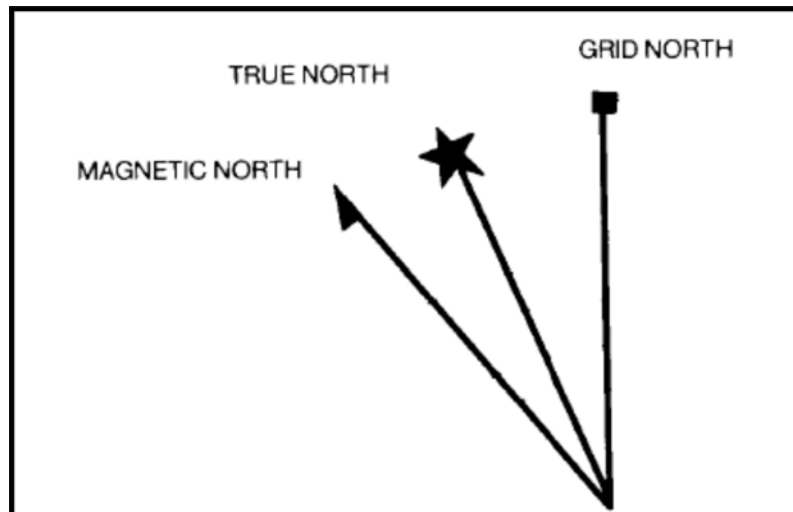

Figure 6 Three Norths

Note. From Maps, Field Sketching, Compasses and the Global Positioning System (p. 51), by Canadian Forces, 2006, Ottawa, ON: Department of National Defence.

3. List the magnetic bearing.

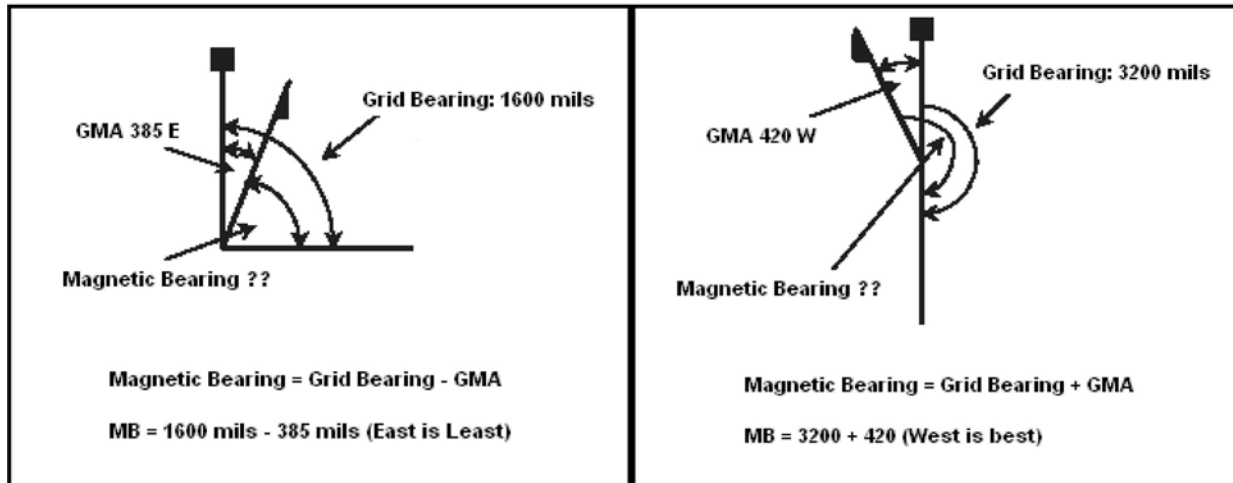



Figure 7 Examples of Converting Grid Bearings to Magnetic Bearings Diagram

Note. From *Land Environmental Training*, by Director Cadets 6 (Personnel, Policy and Training), 2009, Ottawa, ON: Department of National Defence.

The steps to converting a magnetic bearing to a grid bearing are:

1. Calculate the current magnetic declination.
2. Adjust for the magnetic bearing by either adding or subtracting the GMA from the magnetic bearing.



When converting magnetic bearings to grid bearings, the following mathematical formulas are:

- When the GMA is **west** of Grid North, **subtract** the magnetic declination from the magnetic bearing (west is least).
- When the GMA is **east** of Grid North, **add** the magnetic declination to the magnetic bearing (east is best).

3. List the grid bearing.

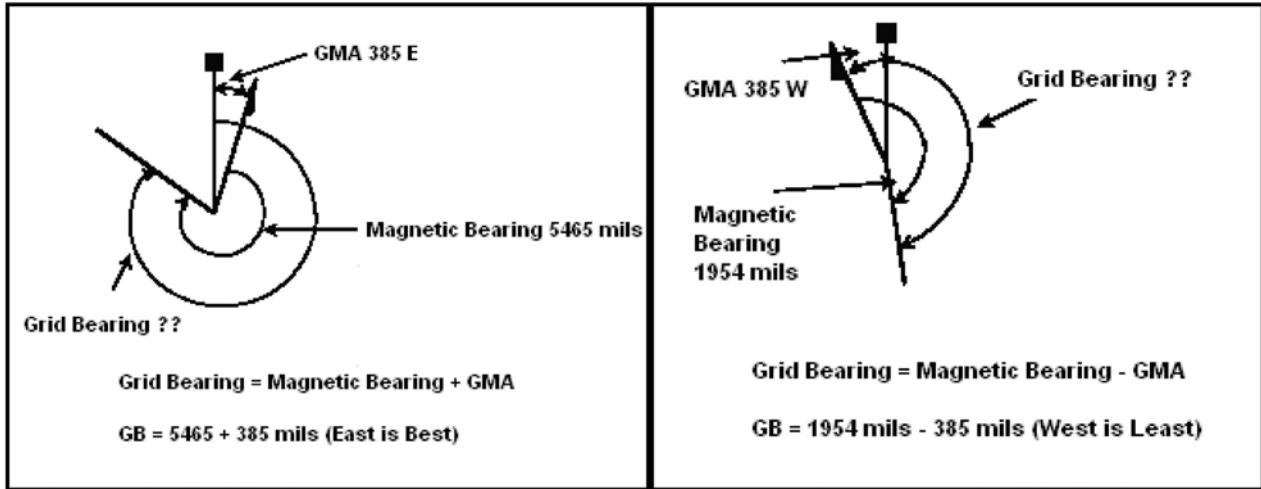



Figure 8 Examples of Converting Magnetic Bearings to Grid Bearings Diagram

Note. From *Land Environmental Training*, by Director Cadets 6 (Personnel, Policy and Training), 2009, Ottawa, ON: Department of National Defence.



Figures 7 and 8 show the relative positions and values of the angles from the information supplied.

It is important to place the bearings in their correct positions relative to each other in accordance with the map information supplied. Once a correct and relative diagram has been made, with the values inserted, the conversion of bearings is straightforward.



Another useful tool is to create a table, Magnetic–Declination–Grid, then add or subtract in the direction referred to by the declination.

Example 1, with all the required information.

| Magnetic | Declination | Grid |
|-----------|-------------|-----------|
| 1725 mils | W 125 mils | 1600 mils |

For West declination, going west, the mathematical formula for finding the magnetic bearing: 1600 mils + 125 mils = 1725 mils.

Example 2, the grid bearing is missing.

| Magnetic | Declination | Grid |
|--|--------------------|-------------|
| 3200 mils | W 250 mils | ? |
| If ? + 250 mils = 3200 mils, then 3200 mils - 250 mils = 2950 mils. The answer is 2950 mils. | | |

Example 3, the magnetic bearing is missing.

| Magnetic | Declination | Grid |
|--|--------------------|-------------|
| ? | W 300 mils | 6050 mils |
| If ? - 300 mils = 6050 mils, then 6050 mils + 300 mils = 6350 mils. The answer is 6350 mils. | | |



All bearings are measured clockwise from their north point. The magnetic bearing will be greater than the corresponding grid bearing by the amount of the GMA.

CONFIRMATION OF TEACHING POINT 4

The cadets' performance of converting bearings will serve as the confirmation of this TP.

END OF LESSON CONFIRMATION

The cadets' measuring of a grid bearing with a protractor will serve as the confirmation of this lesson.

CONCLUSION

HOMEWORK / READING / PRACTICE

Nil.

METHOD OF EVALUATION

Nil.

CLOSING STATEMENT

Knowing how to measure a grid bearing with a protractor enhances map and compass skills and allows cadets to plot bearings by using another useful tool, while navigating confidently during field training exercises.

INSTRUCTOR NOTES / REMARKS

Topographical maps can be requested through RCSU.

REFERENCES

A2-041 B-GL-382-005/PT-001 Directorate of Army Doctrine 8. (2006). *Maps, field sketching, compasses and the global positioning system*. Ottawa, ON: Department of National Defence.

C2-041 ISBN 0-07-136110-3 Seidman, D., & Cleveland, P. (1995). *The essential wilderness navigator*. Camden, ME: Ragged Mountain Press.

THIS PAGE INTENTIONALLY LEFT BLANK

Steps to Measure a Grid Bearing With a Protractor

The steps to measuring a grid bearing with a protractor are:

Step 1. Plot the six-figure GR start and finish points by:

1. sharpening the pencil that is being used, as this will allow for a more accurate plotting of a bearing;
2. identifying, using a romer to create a precise dot, the start GR and marking it as Point A on the map;
3. identifying, using a romer to create a precise dot, the finish GR and marking it as Point B on the map;
4. drawing a straight line, using the edge of the protractor, starting from Point A and continuing to Point B (This line is called the plotting ray); and
5. extending the plotting ray past Point A and B and mark the line with an arrow to indicate the direction of travel. This will make it easier to read the bearing.

Step 2. Place the protractor on the map by:

1. ensuring the centre hole is on the plotting ray and the centre line is over an easting line on the map;
2. orienting zero mils to the top of the map (north); and
3. ensuring the mils scale is placed east or west of the grid lines, as required.

Step 3. Align the protractor parallel to the eastings by:

1. sliding the centre hole along the plotting ray; and
2. matching the vertical line on the protractor with an easting line.

Step 4. Read the grid bearing at the point where the plotting ray crosses through the mils graduations on the side of the protractor by:

1. finding and reading the grid bearing off the protractor on the mils scale;
2. determining which bearing is the correct one; and
3. recording the bearing.

THIS PAGE INTENTIONALLY LEFT BLANK

Steps to Converting Bearings

The steps to converting a grid bearing to a magnetic bearing are:

1. Calculate magnetic declination.
2. Adjust for the magnetic bearing by either adding or subtracting the appropriate angle, which is called the grid magnetic angle (GMA), to / from the grid bearing.



When converting grid bearings to magnetic bearings, the following mathematical formulas are:

- When the GMA is **west** of Grid North, **add** it to the grid bearing (west is best).
- When the GMA is **east** of Grid North, **subtract** it from the grid bearing (east is least).

3. List the magnetic bearing.

The steps to converting a magnetic bearing to a grid bearing are:

1. Calculate magnetic declination.
2. Adjust for the magnetic bearing by either adding or subtracting the GMA from the magnetic bearing.



When converting magnetic bearings to grid bearings, the following mathematical formulas are:

- When the GMA is **west** of Grid North, **subtract** it from the magnetic bearing (west is least).
- When the GMA is **east** of Grid North, **add** it to the magnetic bearing (east is best).

3. List the grid bearing.

The Magnetic–Declination–Grid table. Add or subtract in the direction referred to by the declination.

| Magnetic | Declination | Grid |
|--|-------------|-----------|
| 1725 mils | W 125 mils | 1600 mils |
| For West declination, going west, the mathematical formula for finding the magnetic bearing: 1600 mils + 125 mils = 1725 mils. | | |

THIS PAGE INTENTIONALLY LEFT BLANK



ROYAL CANADIAN ARMY CADETS
GOLD STAR
INSTRUCTIONAL GUIDE



SECTION 8

EO C422.05 – DETERMINE LOCATION USING RESECTION

Total Time:

60 min

PREPARATION

PRE-LESSON INSTRUCTIONS

Resources needed for the delivery of this lesson are listed in the lesson specification located in A-CR-CCP-704/PG-001, *Gold Star Qualification Standard and Plan*, Chapter 4. Specific uses for said resources are identified throughout the instructional guide within the TP for which they are required.

Review the lesson content and become familiar with the material prior to delivering the lesson.

Photocopy the Steps to Determine Location Using Resection handout located at Attachment A for each cadet.

Select a location where three prominent objects are easily identifiable and can be seen both on the map and on the ground. Ensure compasses and topographical maps of the local area are available.

PRE-LESSON ASSIGNMENT

Nil.

APPROACH

A demonstration and performance was chosen for this lesson as it allows the instructor to explain and demonstrate the skill of determining location using resection while providing an opportunity for the cadet to practice the skill under supervision.

INTRODUCTION

REVIEW

Nil.

OBJECTIVES

By the end of this lesson the cadet shall be expected to determine their location using resection, within +/- 500 m.

IMPORTANCE

It is important for cadets to know how to determine their location using resection as it provides the cadet an opportunity to enhance their map and compass skills. If a cadet is required to find their location and / or report their location, they will be able to do so quickly and effectively.

Teaching Point 1**Explain, demonstrate and have the cadets determine their location using resection.**

Time: 50 min

Method: Demonstration and Performance



This TP demonstrates to the cadet how to determine location using resection. For this skill TP, it is recommended that instruction take the following format:

1. Explain and demonstrate the complete skill of determining location using resection while cadets observe, to include:
 - a. calculating the current declination of the topographical map;
 - b. setting the current declination on the compass;
 - c. locating three prominent objects;
 - d. identifying the location of the three prominent objects on the topographical map;
 - e. marking the three prominent objects on the topographical map;
 - f. determining the magnetic bearing to each prominent object using a compass;
 - g. determining the back bearing for each prominent object;
 - h. plotting each back bearing on the topographical map; and
 - i. determining location based on the intersection of the lines or the centre of the triangle created.
2. Explain and demonstrate each step required to determine location using resection.
3. Have the cadets practice each step.
4. Have the cadets practice the complete skill.

Provide guidance to the cadets as they learn how to determine location using resection.

Distribute a copy of the Steps to Determine Location Using Resection Information Sheet located at Attachment A for each cadet, as a reference.



Refer to B-GL-382-005/PT-001, *Maps, Field Sketching, Compasses and the Global Positioning System*, for further information on determining location using resection.

DETERMINE LOCATION USING RESECTION

In the absence of local details and contours on a map, location can be determined from distant objects such as hilltops, corners of woods, other natural features, or buildings. When determining location using resection, it is better to select three points so that a triangle is formed and the location will be inside the triangle.

The steps to determining location using resection are:

1. Calculate the current declination of the topographical map.
2. Set the current declination on the compass.
3. Locate three prominent objects that can be seen from the current location. The three surrounding points should form a triangle.



Ensure that the three prominent objects are readily identifiable objects that can be seen both on the map and on the ground.

4. Identify the location of the three prominent objects on the topographical map.
5. Mark the three prominent objects on the topographical map.
6. Determine the magnetic bearing to each prominent object using a compass.
7. Determine the back bearing for each prominent object.
8. Plot each back bearing on the topographical map by:
 - a. placing the compass on the topographical map, without disturbing the dial setting, so that one side of the base plate intersects the symbol of the object and the compass is pointing in the direction of travel;
 - b. keeping an edge of the compass base on the symbol of the object, lining up the meridian lines on the compass with the easting lines on the map by rotating the compass and ensuring that the edge of the compass is always in contact with the prominent object;



Keep the compass meridian lines that are on the bottom of the dial parallel to the eastings on the map, so the orienting arrow points up or north on the map.

- c. drawing a line along the edge of the compass that intersects and extending the line from the symbol of the object, in the direction of the back bearing; and
 - d. repeating Steps a–c for the second and third prominent objects.
9. The lines should meet in a small triangle. Determine the location from the centre of the triangle created.

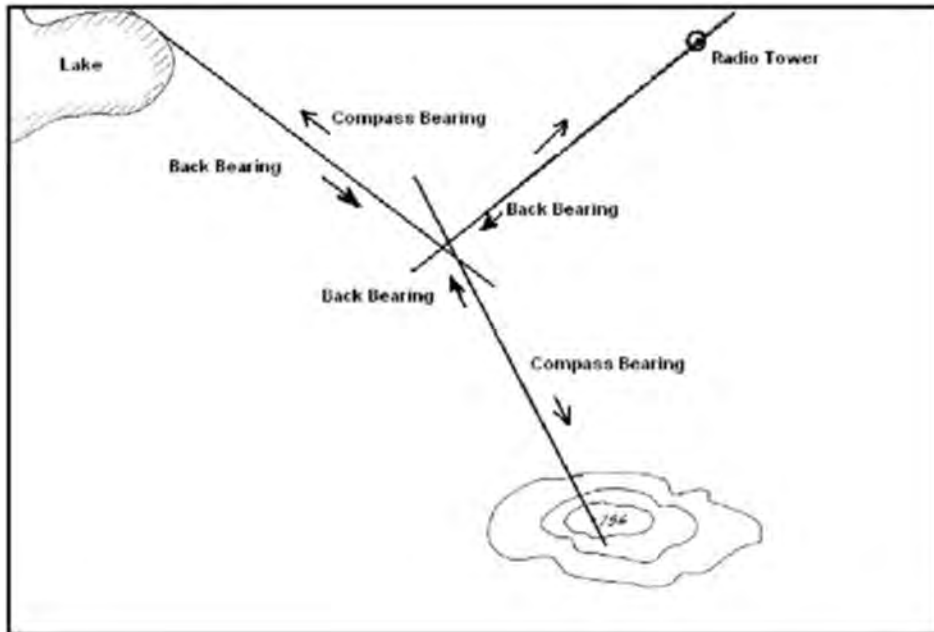

Figure 1 Three-Point Resection

Note. From Royal Canadian Army Cadet Reference Book (p. 5-56), by Director Cadets 3, 2003, Ottawa, ON: Department of National Defence.

CONFIRMATION OF TEACHING POINT 1

QUESTIONS:

- Q1. In the absence of local detail and contours on a map, what type of objects can be used when determining location using resection?
- Q2. When determining location using resection, what are the first two steps that must be completed?
- Q3. After completing the resection, what shape has been created and how do you determine your location?

ANTICIPATED ANSWERS:

- A1. Answers may vary. Some examples may include hilltops, corners of woods, other natural features, or buildings.
- A2. The first two steps are:
 - 1. Calculate the current declination of the topographical map.
 - 2. Set the current declination on the compass.
- A3. The lines should meet in a small triangle. Location is then determined from the centre of the triangle created.

END OF LESSON CONFIRMATION

The cadets' determining their location using resection will serve as the confirmation of this lesson.

CONCLUSION

HOMEWORK / READING / PRACTICE

Nil.

METHOD OF EVALUATION

Nil.

CLOSING STATEMENT

Knowing how to quickly and effectively complete a resection will enhance map and compass skills and will allow location to be determined, while navigating during field training exercises.

INSTRUCTOR NOTES / REMARKS

Nil.

REFERENCES

A2-041 B-GL-382-005/PT-001 Directorate of Army Doctrine 8. (2006). *Maps, field sketching, compasses and the global positioning system*. Ottawa, ON: Department of National Defence.

THIS PAGE INTENTIONALLY LEFT BLANK

Steps to Determine Location Using Resection

The steps to determining location using resection are:

1. Calculate the current declination of the topographical map.
2. Set the current declination on the compass.
3. Locate three prominent objects. The three surrounding points form a triangle.
4. Identify the location of the three prominent objects on the topographical map.
5. Mark the three prominent objects on the topographical map.
6. Determine the magnetic bearing to each prominent object using a compass.
7. Determine the back bearing for each prominent object.
8. Plot each back bearing on the topographical map by:
 - a. placing the compass on the topographical map, without disturbing the dial setting so that one side of the base plate intersects the symbol of the object and the compass is pointing in the direction of travel;
 - b. keeping an edge of the compass base on the symbol of the object, lining up the meridian lines on the compass with the easting lines on the map by rotating the compass and ensuring that the edge of the compass is always in contact with the prominent object;
 - c. drawing a line along the edge of the compass that intersects and extending the line from the symbol of the object, in the direction of the back bearing; and
 - d. repeating Steps a–c for the second and third prominent objects.
9. The lines should meet in a small triangle. Determine location based on the centre of the triangle created.

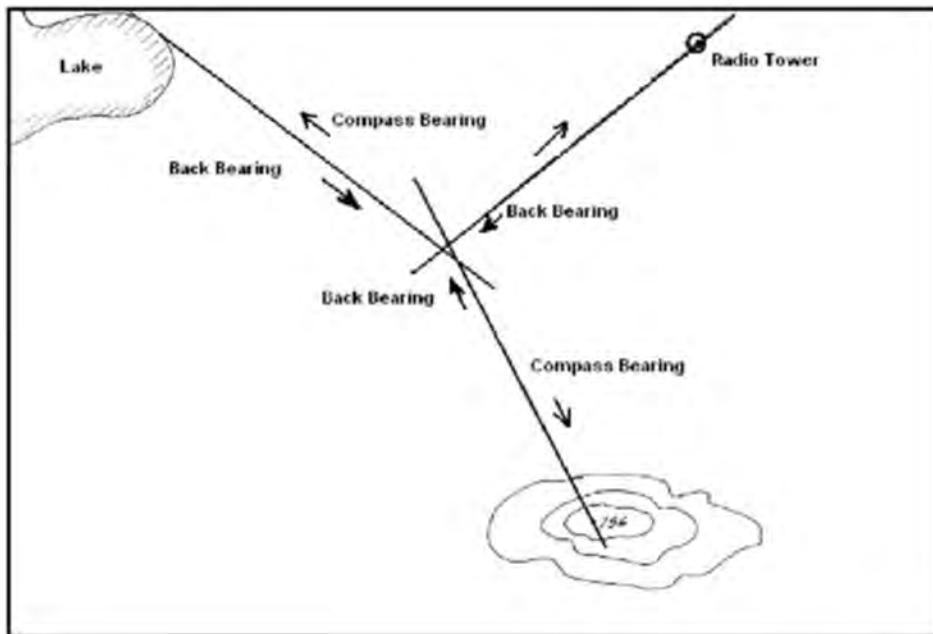

Figure A-1 Three-Point Resection

Note. From *Royal Canadian Army Cadet Reference Book* (p. 5-56), by Director Cadets 3, 2003, Ottawa, ON: Department of National Defence.



ROYAL CANADIAN ARMY CADETS
GOLD STAR
INSTRUCTIONAL GUIDE



SECTION 9

EO C422.06 – PRACTICE NAVIGATION AS A MEMBER OF A SMALL GROUP

| | |
|-------------|---------|
| Total Time: | 270 min |
|-------------|---------|

PREPARATION

PRE-LESSON INSTRUCTIONS

Resources needed for the delivery of this lesson are listed in the lesson specification located in A-CR-CCP-704/PG-001, *Gold Star Qualification Standard and Plan*, Chapter 4. Specific uses for said resources are identified throughout the instructional guide within the TP for which they are required.

Review the lesson content and become familiar with the material prior to delivering the lesson.

Review the five activity descriptions in TP 1. Select one activity to conduct in the allocated time of 80 minutes. Select a different activity for each session conducted.

Confirm the availability of local resources required for the activity selected and prepare the topographical map of the area and the routes being used, to include grid references (GR) and bearings, prior to delivering this lesson.

PRE-LESSON ASSIGNMENT

Nil.

APPROACH

A practical activity was chosen for this lesson as it is an interactive way to allow cadets to experience navigation by setting and following a route using a Global Positioning System (GPS) receiver, in a safe and controlled environment. This activity contributes to physical fitness and to the development of navigation skills and knowledge in a fun and challenging setting.

INTRODUCTION

REVIEW

Nil.

OBJECTIVES

By the end of this lesson the cadet shall have practiced navigation as a member of a small group, using a GPS receiver.

IMPORTANCE

It is important for cadets to practice navigation skills using a map, a compass and a GPS receiver. Participation in these activities contributes to the development of navigation skills and knowledge in a fun and challenging setting. Cadets will rely on this skill set throughout navigation and expedition training.

Teaching Point 1**Have the cadets participate in a navigation activity.**

Time: 80 min

Method: Practical Activity

SUPERVISE NAVIGATION

Green / Red Star cadets will be given a map and a compass to conduct a predetermined navigation activity. Green / Red Star cadets will be given directions by a staff member, and the resources required to complete the chosen activity. Gold Star cadets will supervise and assist the Green / Red Star cadets while they participate in a chosen navigation activity. Gold Star cadets will be provided with a GPS receiver to aid in confirming answers, as required.

NAVIGATION BRAIN TEASER

Using a map, a compass and a GPS receiver, Gold Star cadets will navigate to predetermined points on the map. The course will consist of a minimum of four legs, approximately 500–1 000 m in length. Following the clues provided, when each group arrives at the checkpoint, they will record the GR on the GPS receiver (to ensure they were at each checkpoint) and are given clues (magnetic bearing, GR or distance) directing them to another checkpoint. The clues should make the cadets think about and use their navigation skills to find the next checkpoint. The group that locates the most checkpoints and has the fastest time is the winning group.

Input the provided coordinates using a GPS receiver by:

1. confirming that the GPS receiver is set to the correct coordinate system;
2. confirming that the correct map datum is set;
3. marking the start point, using a personalized mark;
4. establishing three Points of Interest (POIs) using a coordinate mark by:
 - a. pressing MARK;
 - b. moving the arrow joystick to highlight the location field;
 - c. pressing ENTER;
 - d. using the arrow joystick to adjust the characters in the first line (grid zone designation and 100 000-m square identification) of the location field;
 - e. pressing ENTER to move to the second line of the location field;
 - f. using the arrow joystick to adjust the characters in the second line (grid reference) of the location field; pressing ENTER;
 - g. personalizing the POI, if desired (as detailed in Personalize a Mark, Step 2);
 - h. moving the arrow joystick to the save field; and
 - i. pressing ENTER;
5. navigating to the main menu screen;
6. scrolling to SELECT A ROUTE;
7. selecting CREATE A NEW ROUTE;

8. adding the POIs;
9. saving the route; and
10. naming the route.

CONSTRUCT A NAVIGATION COURSE

Gold Star cadets will set up a map and compass navigation activity for the Green or Red Star cadets. The navigation activity must allow the cadets an opportunity to practice and review previous navigation lessons and skills.

Gold Star cadets must consider the following guidelines when planning a navigation activity:

- The overall safety of all navigators. Establish clear boundaries for the exercise and give all navigators a safety bearing. A safety bearing will lead them to a safe area like a road or other distinct feature.
- The skill level of the navigators and what skills need to be practiced in the navigation activity.
- The type of navigation activity and the resources required for the navigation activity.
- A full reconnaissance of the area should be carried out when planning, ensuring the navigation activity has a start, no more than 10 control points and a finish.
- The first and last controls should be relatively easy to find, as this improves a navigator's confidence and keeps the flow of the course going smoothly.
- Control points must be in a safe location and visible from at least 10 m (33 feet) away.
- Have different routes in and out of a control, as this keeps navigators from finding a control by watching someone else come out of it.
- Set a time limit for the activity to be planned and conducted.
- Position water, first aid and supervisors at key controls in the course. For controls without attending supervisors, establish a method (orienteeing punch, sign-up list, etc.) for proving or establishing that a navigator has passed through the control.
- Log the departure and arrival times of navigators so it is known who is still out on the course.
- Brief navigators on safety, rules and safety bearings prior to sending them out on a course. Debrief the navigators after the activity to discover what they learned and how successful the course was.

CATCH A CACHE

Gold Star cadets will be given a map, a compass, a GPS receiver, trinkets and any other information required to navigate to as many geocaches, as they can find in the predetermined time limit. Groups of cadets will seek out the geocaches and upon finding one, fill out the logbook, remove one trinket and replace it with another trinket.

Participate in a geocache search by:

1. receiving all required geocache information for geocaches in the area;
2. setting up the GPS receiver by:
 - a. confirming that the correct coordinate system is set; and
 - b. confirming the correct map datum is set;

3. creating a POI from a coordinate mark by:
 - a. pressing MARK;
 - b. moving the arrow joystick to highlight the location field;
 - c. pressing ENTER;
 - d. using the arrow joystick to adjust the characters in the first line (grid zone designation and 100 000-m square identification) of the location field;
 - e. pressing ENTER to move to the second line of the location field;
 - f. using the arrow joystick to adjust the characters in the second line (grid reference) of the location field;
 - g. pressing ENTER;
 - h. personalizing the POI, if desired (as detailed in Personalize a Mark, Step 2);
 - i. moving the arrow joystick to the save field; and
 - j. pressing ENTER;
4. navigating to the geocache by:
 - a. selecting a GOTO route;
 - b. choosing the geocache POI;
 - c. navigating to the area;
 - d. searching the area of the POI for the geocache; and
 - e. locating the geocache; and
5. swapping a treasure; and
6. reflecting on the experience as a group.

CREATE OR MAINTAIN A CACHE



Use the Stash a Cache form located at Attachment A of C422.02 (Create a Geocache), when creating each geocache.

Gold Star cadets will either create and setup geocache container(s) by hiding them in the surrounding area and marking their coordinates or maintain an existing geocache. Gold Star cadets will be given a map, a compass and a GPS receiver, trinkets and any other information required to create or maintain the geocaches. If time permits, allow other cadets to seek out the geocaches and upon finding one, fill out the logbook, remove one trinket and replace it with another trinket.

Identify the geocache coordinates by:

1. setting the desired coordinate system;
2. setting the correct datum;

3. recording the coordinates at the location; and
4. describing the geocache's physical location.



Depending on terrain selected and complexity of the navigation instructions, a navigation trail can be as easy or as challenging as you wish to make it.

ACTIVITY

Time: 80 min

OBJECTIVE

The objective of the Supervise Navigation activity is to have the Gold Star cadets supervise and assist the Green / Red Star cadets while they participate in a navigation activity.

RESOURCES

- GPS receiver (one per cadet),
- Whistle (one per cadet), and
- Any other resources required to complete the activity.

ACTIVITY LAYOUT

Nil.

ACTIVITY INSTRUCTIONS

1. Conduct a safety briefing, to include an explanation of:
 - a. actions to be taken if a cadet becomes lost;
 - b. time limits for the activity;
 - c. boundaries;
 - d. rules and safety procedures for the activity; and
 - e. a narrative of the specific activity being conducted.
2. Divide the Gold Star cadets into groups by the number of Green / Red Star cadet groups.
3. Issue each Gold Star group a GPS receiver.
4. Refer to and follow the Green / Red Star cadets' navigation activity instructions for the chosen activity by confirming answers, as required, with a GPS receiver.
5. Have the Gold Star cadets supervise and assist Green / Red Star cadets as they conduct a navigation activity.

6. Conduct a debriefing where the cadets may be asked:
 - a. how they felt about the activity;
 - b. what they felt they accomplished;
 - c. what they would try to improve on if given the opportunity to complete the activity again; and
 - d. what they learned about using a GPS with a map.



If available, use an assistant instructor at each checkpoint to answer questions and to prevent groups from following each other or sharing answers.

SAFETY

Cadets shall be briefed on boundaries which must take into account any dangerous obstacles or crossings. If radios are available, each group should be given a radio.

ACTIVITY

Time: 80 min

OBJECTIVE

The objective of the Navigation Brain Teaser activity is to have the cadets, as members of a small group, find as many checkpoints as possible.

RESOURCES

- GPS receiver (one per group),
- Topographical map (one per group),
- Compass (one per group),
- Whistle (one per cadet),
- Paper, and
- A predetermined navigation route with checkpoints.

ACTIVITY LAYOUT

- Clearly mark the start and finish lines.
- Position a clue(s) at each checkpoint to direct the groups to the next checkpoint.

ACTIVITY INSTRUCTIONS



The clues should not be too easy or too hard for the cadets to find each checkpoint. Stagger the clues to prevent groups from following each other or sharing answers.

Examples of this may include:

- having groups enter or leave checkpoints at different directions; and
- having the order of checkpoints different for each group.

1. Conduct a safety briefing, to include an explanation of:
 - a. actions to be taken if a cadet becomes lost;
 - b. time limits for the activity;
 - c. boundaries;
 - d. rules and safety procedures for the activity; and
 - e. a narrative of the specific activity being conducted.
2. Divide the cadets into groups by the number of GPS receivers available.
3. Issue each group a map, a compass, and a GPS receiver.
4. Give the clue for the first checkpoint to the cadet leading the group.
5. Have the cadet leading the group input their provided coordinates and follow them along a route.
6. Start groups at two-minute intervals and record start times.
7. On a piece of paper, have cadets record clues in the order they complete the checkpoints.
8. Have cadets alternate turns leading the group at least once.
9. Collect sheets and record the finish time for each group.
10. Announce the group that locates the most checkpoints and has the fastest time as the winning group.
11. Conduct a debriefing where the cadets may be asked:
 - a. how they felt about the activity;
 - b. what they felt they accomplished;
 - c. what they would try to improve on if given the opportunity to complete the activity again; and
 - d. what they learned about using a GPS with a map.



If available, use an assistant instructor at each checkpoint to give cadets the next clue and answer questions.

SAFETY

Cadets shall be briefed on boundaries which must take into account any dangerous obstacles or crossings. If radios are available each group should be given a radio.

ACTIVITY

Time: 80 min

OBJECTIVE

The objective of the Construct a Course activity is to have the cadets set up a map and compass navigation activity.

RESOURCES

- GPS receiver (one per group),
- Topographical map (one per group),
- Compass (one per group),
- Whistle (one per cadet),
- Any other resources required to complete the activity.

ACTIVITY LAYOUT

Nil.

ACTIVITY INSTRUCTIONS

1. Conduct a safety briefing, to include an explanation of:
 - a. actions to be taken if a cadet becomes lost;
 - b. time limits for the activity;
 - c. boundaries;
 - d. rules and safety procedures for the activity; and
 - e. a narrative of the specific activity being conducted.
2. Have the cadets set up the navigation activity that allows an opportunity to practice and review previous navigation lessons and skills.
3. Conduct the navigation activity, ensuring the guidelines when planning a navigation activity are followed.
4. Conduct a debriefing where the cadets may be asked:
 - a. how they felt about the activity;
 - b. what they felt they accomplished;
 - c. what they would try to improve on if given the opportunity to complete the activity again; and
 - d. what they learned about using a GPS with a map.

SAFETY

Cadets shall be briefed on boundaries which must take into account any dangerous obstacles or crossings. If radios are available each group should be given a radio.

ACTIVITY

Time: 80 min

OBJECTIVE

The objective of the Catch a Cache activity is to have the cadets, as members of a small group, locate geocaches.

RESOURCES

- GPS receiver (one per group),
- Geocache coordinates,
- Topographical map of the local area (one per group),
- Whistle (one per cadet),
- Paper, and
- Geocache treasures (eg, pencils, stickers, trinkets).

ACTIVITY LAYOUT

- Identify existing geocaches or create complete geocache containers, hide them in the surrounding area and mark their coordinates.
- Establish a finish time, which may include a point score penalty system for late arrivals.
- Establish a finish location.

ACTIVITY INSTRUCTIONS

To keep things interesting, the difficulty of finding the landmarks should vary.

1. Conduct a safety briefing, to include an explanation of:
 - a. actions to be taken if a cadet becomes lost;
 - b. time limits for the activity;
 - c. boundaries;
 - d. rules and safety procedures for the activity; and
 - e. a narrative of the specific activity being conducted.

2. Divide the cadets into groups by the number of GPS receivers available.
3. Issue each group the resources required to conduct the activity.
4. Give each group all required geocache information.
5. Have the cadet leading the group input their provided coordinates and navigate to the geocache.
6. Groups may start at the same time or at intervals, depending on the number of groups.
7. On a piece of paper, have cadets record the GR coordinates of each geocache as they find it.
8. Have the cadets alternate leading the group and using the GPS to identify the geocaches.
9. Have the cadets place a trinket in each geocache and record the information in the logbook.
10. Conduct a debriefing where the cadets may be asked:
 - a. how they felt about the activity;
 - b. what they felt they accomplished;
 - c. what they would try to improve on if given the opportunity to complete the activity again; and
 - d. what they learned about using a GPS with a map.

SAFETY

Cadets shall be briefed on boundaries which must take into account any dangerous obstacles or crossings. If radios are available each group should be given a radio.

ACTIVITY

Time: 80 min

OBJECTIVE

The objective of the Create a Cache activity is to have the cadets create and set up a geocache(s) or maintain an existing geocache(s).

RESOURCES

- GPS receiver (one per group),
- Compass (one per group),
- Topographical map of the local area (one per group),
- Whistle (one per cadet),
- Paper, and
- Geocache treasures (eg, pencils, stickers, trinkets).

ACTIVITY LAYOUT

- Create complete or maintain existing geocache containers.
- Establish a start and finish location.

ACTIVITY INSTRUCTIONS

1. Conduct a safety briefing, to include an explanation of:
 - a. actions to be taken if a cadet becomes lost;
 - b. time limits for the activity;
 - c. boundaries;
 - d. rules and safety procedures for the activity; and
 - e. a narrative of the specific activity being conducted.
2. Divide the cadets into groups by the number of GPS receivers and compasses available.
3. Issue each group the resources required to conduct the activity.
4. Have the cadets determine a location for each geocache.
5. Have the cadets record the coordinates of each geocache in their GPS receiver.
6. On a piece of paper, have cadets record the GR coordinates and details of each geocache.
7. Have cadets alternate using the GPS receiver to create or maintain the geocaches, as required.
8. Conduct a debriefing where the cadets may be asked:
 - a. how they felt about the activity;
 - b. what they felt they accomplished;
 - c. what they would try to improve on if given the opportunity to complete the activity again; and
 - d. what they learned about using a GPS with a map.

SAFETY

Cadets shall be briefed on boundaries which must take into account any dangerous obstacles or crossings. If radios are available each group should be given a radio.

CONFIRMATION OF TEACHING POINT 1

The cadets' participation in the navigation activity will serve as the confirmation of this TP.

END OF LESSON CONFIRMATION

The cadets' participation in the navigation activity will serve as the confirmation of this lesson.

CONCLUSION

HOMEWORK / READING / PRACTICE

Nil.

METHOD OF EVALUATION

Nil.

CLOSING STATEMENT

Navigating using a GPS receiver or a map and compass are skills that can also be used in situations outside the Cadet Program. True proficiency in these skills used during these activities can only be achieved by practicing. These activities allow the cadets the opportunity to develop their navigation skills and knowledge in a fun and challenging setting.

INSTRUCTOR NOTES / REMARKS

If a different GPS receiver is being used for the navigation exercise, refer to the user manual for that receiver.

This EO may be conducted in conjunction with Green and Red Star map and compass practice (eg, EO C122.01 [Practice Navigation as a Member of a Small Group] and EO C222.01 [Practice Navigation Using a Map and Compass]). When the Green and Red Star cadets practice using a map and compass, the Gold Star cadets use the GPS receiver.

This complementary activity can be carried out as nine periods during a supported day or over three sessions of three periods each, to a maximum of nine periods.

If cadets are assigned as team leaders, they will be debriefed on their performance as part of PO 403 (Act as a Team Leader)

Assistant instructors are required for this lesson.

REFERENCES

A2-036 A-CR-CCP-121/PT-001 Director Cadets 3 (2003). *Royal Canadian Army cadet reference book*. Ottawa, ON: Department of National Defence.

A2-041 B-GL-382-005/PT-001 Directorate of Army Doctrine 8. (2006). *Maps, field sketching, compasses and the global positioning system*. Ottawa, ON: Department of National Defence.

C1-178 Thales Navigation Inc. (2004). *Magellan eXplorist 200 GPS user manual*. San Dimas, CA: Thales Navigation Inc.

C2-142 ISBN 0-7645-6933-3 McNamara, J. (2004). *GPS for dummies*. Hoboken, NJ: Wiley Publishing, Inc.



ROYAL CANADIAN ARMY CADETS

GOLD STAR

INSTRUCTIONAL GUIDE



SECTION 1

EO M424.01 – SHARPEN A SURVIVAL KNIFE

Total Time:

60 min

PREPARATION

PRE-LESSON INSTRUCTIONS

Resources needed for the delivery of this lesson are listed in the lesson specification located in A-CR-CCP-704/PG-001, *Gold Star Qualification Standard and Plan*, Chapter 4. Specific uses for said resources are identified throughout the instructional guide within the TP for which they are required.

Review the lesson content and become familiar with the material prior to delivering the lesson.

PRE-LESSON ASSIGNMENT

Nil.

APPROACH

An interactive lecture was chosen for TPs 1–4 to introduce the cadet to a survival knife and how to care for and maintain a survival knife.

A demonstration and performance was chosen for TP 5 as it allows the instructor to explain and demonstrate sharpening a survival knife while providing the cadet the opportunity to practice these skills under supervision.

INTRODUCTION

REVIEW

Nil.

OBJECTIVES

By the end of this lesson the cadet shall have sharpened a survival knife with a sharpening stone.

IMPORTANCE

It is important for cadets to know how to sharpen a knife as it is an invaluable asset in the field. In a survival situation, a knife serves a number of purposes such as chopping, cutting, slicing and sawing. Having a sharp knife will allow the cadet to make the necessities they will need to live and thrive in the outdoors.

Teaching Point 1**Identify types of knives.**

Time: 5 min

Method: Interactive Lecture

TYPES OF KNIVES

Knives come in many varieties and serve many purposes, including carving, hunting and survival. This TP will discuss three types of knives that are commonly carried by outdoorsmen.

If possible, have the three types of knives available so the cadet can see the differences between them.

Folding Blade

A folding blade knife connects the blade to the handle through a pivot, allowing the blade to fold into the handle. The blade typically has a locking mechanism to stop the blade from accidentally closing on the user. Some types of locking mechanisms include slip joint, lockback, liner lock, frame lock, and pick lock.



The following are locking mechanisms on a folding blade knife:

- **Slip joint.** Holds the blade in place by a spring device that allows the blade to fold when a certain amount of pressure is applied.
- **Lockback.** Includes a pivoted latch connected to a spring that can be disengaged only by pressing the latch down to release the blade.
- **Liner lock.** Uses a leaf spring-type liner within the groove of the handle that snaps into position under the blade when it is open. The lock is released by pushing the liner to the side, allowing the blade to return to its groove in the handle.
- **Frame lock.** Also known as an integral lock or monolock. This locking mechanism works in a similar manner to the liner lock but uses a partial cut-out of the actual knife handle, rather than a separate liner inside the handle to hold the blade in place.
- **Pick lock.** A round post on the back base of the blade locks into a hole in a spring tab in the handle. To close, manually lift the spring tab off the blade post, or swivel the bolster clockwise to lift the spring tab off the blade post.



Figure 1 Folding Blade

Note. From “R.L. Hammette & Associates”, by R. L. Hammette & Associates, 2009, *Lockback Knife*. Copyright 2009 by R.L. Hammette & Associates. Retrieved February 25, 2009, from <http://www.hammette.com/knives.htm>

Fixed Blade



Tang. The part of the blade that extends into the handle for strength. When the tang of the knife is full, the edge of the entire tang can be seen along the handle. A full tang is a solid piece of steel from tip to butt and is the strongest blade / handle arrangement.

A fixed-blade knife does not fold or slide. The blade is typically stronger due to the tang and lack of moving parts. It is best suited for use as a survival knife. The fixed-blade knife is a simple design; however, custom fixed-blade knives are produced in many different variations.



Figure 2 Fixed Blade

Note. From “Knives Plus Retail Cutlery and Cutlery Accessories Since 1987”, by Knives Plus Retail Cutlery Accessories Since 1987, 2008, *Buck Gen 5 Skinner*. Copyright 2001–2008 by Knives Plus, Inc. Retrieved February 26, 2009, from <http://www.knivesplus.com/buckknifebu-5rws.html>

Multi-purpose

These knives come with many tools that may be useful in a survival situation. Some of these knives have bigger blades making them more suitable as a primary knife. However, these knives may have poor blade locks and small, weak blades, limiting their usefulness as a primary knife.



Figure 3 Multi-purpose Knife

Note. From “Leatherman”, by Leatherman Tool Group, Inc, *Charge ALX*. Copyright 2009 by Leatherman Tool Group, Inc. Retrieved February 26, 2009, from <http://www.leatherman.com/multi-tools/full-size-tools/charge-alx.aspx>

CONFIRMATION OF TEACHING POINT 1

QUESTIONS:

- Q1. What three types of knives may be used as a survival knife?
- Q2. What type of knife would be best suited as a survival knife?
- Q3. What are some of the negative factors that limit the multi-purpose knife as a survival knife?

ANTICIPATED ANSWERS:

- A1. Three types of knives that may be used as a survival knife are the folding blade, fixed blade and multi-purpose knives.
- A2. The knife that would be best suited as a survival knife is the fixed-blade knife.
- A3. A multi-purpose knife can have a small, weak blade combined with a poor blade locking mechanism.

Teaching Point 2**Describe the parts of a survival knife.**

Time: 5 min

Method: Interactive Lecture



During this TP, point out the parts of the survival knife as each one is mentioned.

PARTS OF A KNIFE

A knife is the most common item carried by individuals who enjoy the outdoors and participate in expedition training. Not all knives have all of the parts listed, as it depends on the cost and intended use of the knife. The following parts are listed for a fixed-blade knife:

1. **Blade.** The cutting portion of the knife.
2. **Cutting edge.** The bottom edge of the blade. It can be very sharp and is used to slice, cut and chop.
3. **Tip or point.** Sharp tip of the blade.
4. **Back.** The back edge of the blade, also called the top or spine.
5. **Handle.** Where the user grasps the knife. It is comprised of many components including the bolsters, scales, fittings, sculpting, spacers, pins and tang framework.
6. **Tang.** The piece of the blade that extends into the handle for strength.
7. **Scale or slab.** The material that makes up the knife handle. These can be man-made or natural material such as bone, wood or ivory. Scales are pinned or riveted to the tang.
8. **Butt plate or pommel.** A metal piece at the end or the back of the handle. It is the butt area of the knife.
9. **Pins or rivets.** The hardware that is used to join scale handles to the tang.
10. **Shank.** Consists of the tang and blade. It is the continuous body of the knife.
11. **Spacers.** Material layered between the handle and the hilt or guard of the knife. The spacer is used to adjust the fit of the handle. The material can be any metal, (copper, brass, nickel, silver, or stainless steel) plastic and / or leather.
12. **Hilt.** Can also be referred to as the bolster or guard. It is the cross member attached to the blade and prevents the hand from sliding up onto the blade.
13. **Finger grips.** Grooves that are cut or shaped into the handle so that it fits the hand comfortably (as illustrated in Figure 5).
14. **Hollow grind.** The grind of the blade is where the side of the knife is hollowed out. Knives with a hollow grind cut easier, but are not as strong. A hollow grind is also known as the concave bevel (as illustrated in Figure 5).



Figure 4 Knife Parts

Note. Created by Director Cadets 3, 2009, Ottawa, ON: Department of National Defence.



Figure 5 Hollow Grind and Finger Grips

Note. From "Foldingknife.com", by Foldingknife.pro 2007, *Kalinga Pro*. Copyright 2007 by Foldingknife.pro.com. Retrieved March 9, 2009, from <http://www.foldingknife.pro.com/pro1322538.html>

CONFIRMATION OF TEACHING POINT 2

QUESTIONS:

- Q1. Identify six parts of a survival knife and explain each part.
- Q2. What is a shank?
- Q3. What is a tang?

ANTICIPATED ANSWERS:

A1. Any six of the following:

- blade,
- cutting edge,
- tip or point,
- back,

- handle,
- tang,
- scale,
- butt plate or pommel,
- pins or rivets,
- shank,
- spacers,
- hilt,
- finger grips, and
- hollow grind.

A2. Shank refers to the tang plus blade, the continuous body of the knife.

A3. Tang refers to the piece of the blade that extends into the handle for strength.

Teaching Point 3

Describe the characteristics of a survival knife.

Time: 5 min

Method: Interactive Lecture

CHARACTERISTICS OF A SURVIVAL KNIFE

Length of the Blade

The ideal survival knife should have a blade length somewhere between 10–15 cm (4–6 inches). This size of blade offers a good mix of size and control. Anything bigger is bulky and adds to the weight of the survival gear.



Figure 6 Blade Length

Note. From “Knives Plus Retail Cutlery and Cutlery Accessories Since 1987”, by Knives Plus Retail Cutlery Accessories Since 1987, 2008, *Buck Gen 5 Skinner*. Copyright 2001–2008 by Knives Plus, Inc. Retrieved February 26, 2009, from <http://www.knivesplus.com/buckknifebu-5rws.html>

Width of the Blade

The optimum survival knife will generally have a blade thickness of between 0.4–0.6 cm (5 / 32 to 8 / 32 inches). Any thinner and the blade becomes too flexible; yet thicker blades lack the finesse for the finer work for which survival knives may be used.



Figure 7 Blade Width

Note. Created by Director Cadets 3, 2009, Ottawa, ON: Department of National Defence.

Composition of the Blade

The material of a knife blade will affect the durability and maintenance of the knife. Most blades are made of stainless steel, an alloy that contains chromium to make it corrosion-resistant. Chromium is softer than steel and is blended with stainless steel. Stainless steel blades offer a compromise between rust resistance, edge retention and ease of sharpening.



Numbers marked on the blade (usually a 400 number) indicate the type of alloy used. For example, a marine knife that will be exposed to salt water, salt air and spray is usually made of rust-resistant, high chromium steel such as 420. A blade intended for frequent cutting or food preparation will be harder steel such as 440.

Letters A, B, and C indicate progressively higher levels of carbon and thus harder steel. A harder blade will hold a sharp edge longer, but will be more difficult to sharpen.

The two main types of steel used in making high quality survival knives are:

- **Carbon steel.** Knife blades are tough, can be very sharp, retain their sharp edge fairly well and sharpen with little effort. They have a tendency to be brittle and can break under stress. This blade will rust if not used or cleaned regularly or coated. Carbon steel blades hold an edge better than their stainless steel counterparts.
- **Stainless steel.** Knife blades are rust resistant and work especially well in wet environments. They require less care than the carbon steel knives. Drawbacks to using stainless steel knives are that they tend to be more expensive, are more difficult to sharpen, and may not hold an edge as well.

Some factors a user may want to consider when determining which type of survival knife to use are:

- how the knife will be used;
- how easy it is to sharpen;
- how well it keeps a sharp edge; and
- how susceptible is it to corrosion.

Length of Tang

An optimum survival knife is constructed of one piece of metal (tang) to which there may be slabs of material attached to form a comfortable handle. A full tang is a solid piece of steel from tip to butt and is the strongest blade / handle arrangement. This kind of construction is known in among those who know knives as full tang or narrow tang.

- **Full tang.** The blade merges into the handle (this is the best option and stronger of the two types of tang).
- **Narrow tang.** The size of the blade material is reduced as it enters the handle.



Figure 8 Tang

Note. From "Recipetips.com", by Types of Kitchen Knives, 2009, *Types of Kitchen Knives—Tang*. Copyright 2009 by Tecstra Systems. Retrieved February 27, 2009, from <http://www.recipetips.com/kitchen-tips/t--1075/types-of-kitchen-knives.asp#maintaining>



Poorly constructed or cheap survival knives are often made so that the metal blade is separate from the handle. This type of construction creates a weak point where the blade and handle may break and separate.

Composition of the Handle

The handle is comprised of many components including:

- bolsters,
- scales,
- fittings,
- spacers,
- pins, and
- tang.

The handle will be made of a specific material such as horn, bone, ivory or some other man-made material(s).

CONFIRMATION OF TEACHING POINT 3

QUESTIONS:

- Q1. What is the recommended blade length for a survival knife?
- Q2. What two types of materials make up the composition of the blade?
- Q3. What does the letter designation on a blade represent?

ANTICIPATED ANSWERS:

- A1. The recommended blade length for a survival knife should be 10–15 cm (4–6 inches).
- A2. The two types of material that make up the blade composition are carbon steel and stainless steel.
- A3. The letter designation indicates progressively higher levels of carbon and thus harder steel.

Teaching Point 4**Explain the care and maintenance of a survival knife.**

Time: 5 min

Method: Interactive Lecture

CARE AND MAINTENANCE OF A SURVIVAL KNIFE**Practicing Proper Usage**

When handling the knife the cadet must practice the following:

- Always cut away from the body, never toward.
- If the knife slips and is dropped, let it fall to the ground. Trying to catch it could cause serious injury.
- Never point or use a knife in the direction of another person.
- Never walk or run around with an open or unsheathed knife.
- Do not throw or place the blade into soil; this will rapidly dull the blade.
- Use the knife in one location and close or sheath the knife before moving.
- Do not use a knife for prying lids open; it may damage the tip of the knife.
- Do not throw a knife to anyone. Hand it to them butt first so the receiver can grasp the handle.

Cleaning

A knife is low maintenance but should be cleaned on a regular basis (using a towel and cotton swabs). If water is used to remove stubborn debris, make sure the knife is completely dry before storage to stop rust from forming. Wiping the knife down with a clean towel and lightly blowing it with a hair dryer, if available, will ensure the knife is completely dry and ready for storage. Lightly wipe the blade with oil two to three times a year to keep rust from forming.

If the knife blade has a blue, grey, or black colour, it is a sign of oxidation and the precursor to rust—clean and oil the knife immediately.

Storing

When storing a knife for a prolonged period of time, keep it in a location that is dry and out of direct sunlight. Ensure the knife is clean before storage and secure it so it will not rub against other items. Do not store in a leather sheath. Leather is a natural material and can harm a blade because it will cause the blade to sweat and attract moisture. The acids soaked into the leather during the tanning process could leach out and damage the knife.

Sharpening

Every knife requires sharpening from time to time. Ideally, a sharpening stone should be used; however, if that is unavailable, any sandstone, such as grey clay, quartz, or granite should be used. Rub two pieces of stone together to make them smooth and follow the sharpening process described later in the lesson.



Never sharpen a knife on a power-driven grinding wheel. This can burn the temper from your blade, which will make the edge brittle and possibly chip or crack.



Figure 9 Sharpening Stone

Note. From "Recipetips.com", by Types of Kitchen Knives, 2009, *Types of Kitchen Knives—Sharpening Stone*. Copyright 2009 by Tecstra Systems. Retrieved February 27, 2009, from <http://www.recipetips.com/kitchen-tips/t--1075/types-of-kitchen-knives.asp#maintaining>

CONFIRMATION OF TEACHING POINT 4

QUESTIONS:

- Q1. Identify three guidelines to handling a knife.
- Q2. What is a sign that oxidation is beginning to occur on a knife blade?
- Q3. How should a knife be stored for a prolonged period?

ANTICIPATED ANSWERS:

- A1. Guidelines to handling a knife include:
 - Always cut away from the body, never toward.
 - If the knife slips and is dropped, let it fall to the ground. Trying to catch it could cause serious injury.
 - Never point or use a knife in the direction of another person.
 - Never walk or run around with an open or unsheathed knife.
 - Do not throw or place the blade into soil; this will rapidly dull the blade.
 - Use the knife in one location and close or sheath the knife before moving.
 - Do not use a knife for prying lids open; it may damage the tip of the knife.
 - Do not throw a knife to anyone. Hand it to them butt first so the receiver can grasp the handle.
- A2. If the knife is found to have a blue, grey, or black color, it is a sign of oxidation and the precursor to rust.
- A3. When storing a knife for a prolonged period of time, keep it in a location that is dry and out of direct sunlight. Ensure the knife is clean before storage. Do not store a knife in a leather sheath.

Teaching Point 5**Explain, demonstrate and have the cadets sharpen a survival knife.**

Time: 30 min

Method: Demonstration and Performance



For this TP, it is recommended that instruction take the following format:

1. Have the cadets lay out their sharpening stone and knife in front of them.
2. Explain and demonstrate each step to sharpen a survival knife and have the cadets then practice it.
3. Have the cadets continue to sharpen the survival knife after all steps have been observed and practiced.

Note: Assistant instructors may be used to monitor the cadets' performance.

STEPS TO SHARPEN A SURVIVAL KNIFE

For best results use the appropriate sharpening stone. A fine grit stone will be useful for quick touch-ups on blades that are not too dull. For a more thorough sharpening on a blade that is dull, use a heavier coarse grit stone first, then go to the fine grit stone.

1. **Lubricate the sharpening stone.** To prepare the sharpening stone, apply a light-weight oil or water to assist sharpening the blade. The oil or water will allow the knife to glide across the stone with ease and disperse the heat buildup that may affect the temper of the steel. A stone can be used dry but is not recommended.
2. **Lay the sharpening stone on a flat surface.** The sharpening stone should be positioned on a flat surface. This will allow the user to adjust the angle at which they sharpen the knife.



Figure 10 Placement of the Sharpening Stone

Note. From "Recipetips.com", by Types of Kitchen Knives, 2009, *Types of Kitchen Knives—Sharpening Stone*. Copyright 2009 by Tecstra Systems. Retrieved February 27, 2009, from <http://www.recipetips.com/kitchen-tips/t--1075/types-of-kitchen-knives.asp>

3. **Hold the survival knife by the handle.** Hold the knife firmly by placing the handle in one hand with the index finger on top of the blade and the thumb on the back / spine. The blade should be facing away from the individual. Place the fingers of the other hand along the length of the blade.



Figure 11 Holding the Knife

Note. From "Recipetips.com", by Types of Kitchen Knives, 2009, *Using a Sharpening Stone*. Copyright 2009 by Tecstra Systems. Retrieved February 27, 2009, from <http://www.recipetips.com/kitchen-tips/t--1075/types-of-kitchen-knives.asp>

4. **Determine the sharpening angle of the knife blade.** Place the edge of the knife on the stone so it is angled at the same bevel (the angle at which the blade is made) as the edge of the knife, which should be at a 20-degree angle. The sharp edge should be facing away from the individual.



Figure 12 Sharpening Angle

Note. From "Recipetips.com", by Types of Kitchen Knives, 2009, *Using a Sharpening Stone*. Copyright 2009 by Tecstra Systems. Retrieved February 27, 2009, from <http://www.recipetips.com/kitchen-tips/t--1075/types-of-kitchen-knives.asp>

5. **Apply pressure to the blade while pushing it in a circular motion on the sharpening stone.** Start at the tip and grind in a counter-clockwise motion as if cutting a fine sliver off the surface of the stone. Continue to lightly rotate in this circular motion on the stone while gradually moving the length of the blade across the stone, keeping consistent pressure. Grind along the entire length of the blade edge.

As the knife edge is being sharpened, a slight ridge will form along the edge on the side that is not being sharpened. This ridge indicates that the other side is ready to be sharpened.

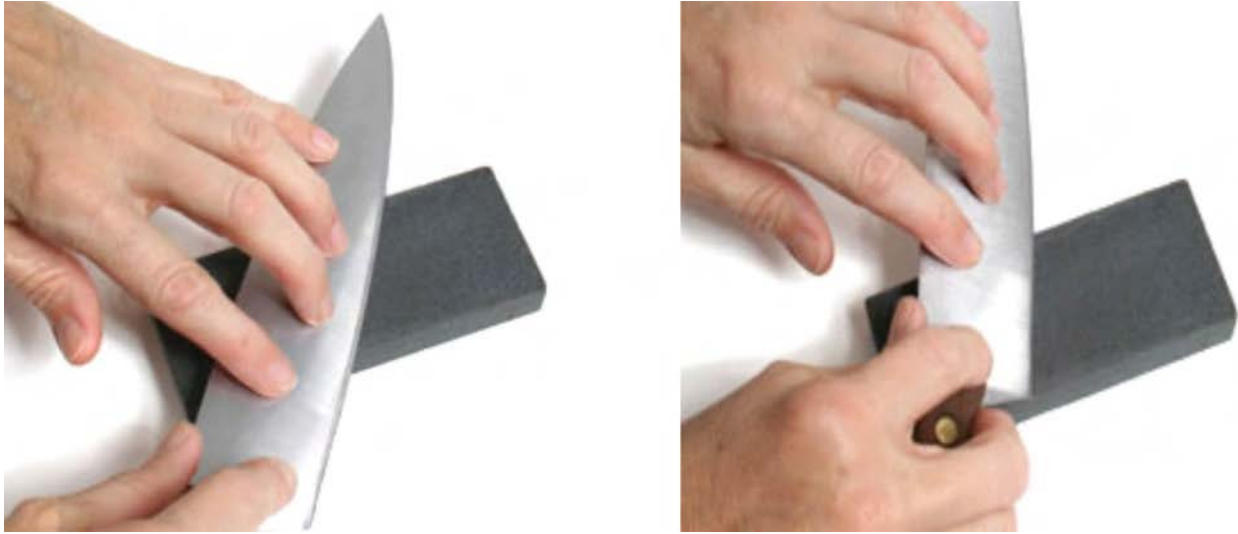

Figure 13 Sharpening the Knife

Note. From "Recipetips.com", by Types of Kitchen Knives, 2009, *Using a Sharpening Stone*. Copyright 2009 by Tecstra Systems. Retrieved February 27, 2009, from <http://www.recipetips.com/kitchen-tips/t--1075/types-of-kitchen-knives.asp>

6. **Turn the survival knife over and sharpen the other side of the knife.** As the knife edge is being sharpened, a slight ridge will form along the edge on the side that is not being sharpened. This ridge indicates that the other side is ready to be sharpened. To detect the ridge, use a fingernail (as illustrated in Figure 14) and run it along the edge of the side of the blade that has not been sharpened. If the fingernail catches the edge, the blade is ready to have the other side sharpened. Be sure to check the ridge in several locations along the length of the blade to ensure the entire blade has been sharpened. If there is a spot that has not been sharpened, go back and sharpen that area again.



Figure 14 Checking the Bevelled Edge

Note. From "Recipetips.com", by Types of Kitchen Knives, 2009, *Using a Sharpening Stone*. Copyright 2009 by Tecstra Systems. Retrieved February 27, 2009, from <http://www.recipetips.com/kitchen-tips/t--1075/types-of-kitchen-knives.asp>

Once the first side of the knife has been sharpened properly, turn the knife over so the blade edge is facing toward the individual. Hold the knife in the same manner as when sharpening the first side. Now the hand holding the handle will have the forefinger on the spine and the thumb will be on the blade (illustrated in Figure 15).

Begin grinding at the tip in a counter-clockwise direction in the same manner as before. Carefully apply consistent pressure across the blade. When finished grinding the second side, check again for the ridge to have formed. If it has not formed, continue to grind in those areas until the ridge forms.



Figure 15 Sharpening the Reverse Side of the Knife

Note. From "Recipetips.com", by Types of Kitchen Knives, 2009, *Using a Sharpening Stone*. Copyright 2009 by Tecstra Systems. Retrieved February 27, 2009, from <http://www.recipetips.com/kitchen-tips/t--1075/types-of-kitchen-knives.asp>

7. **Check to ensure the survival knife is sharp.** There are various ways to check the sharpness of the blade, such as:

- rubbing the thumb lightly across the blade perpendicular to the length of the blade;
- cutting a piece of paper, watching to see that the knife slices with ease through the paper—the paper should have a clean cut with no tearing; or
- slicing a piece of fruit—there should be little resistance when slicing the fruit.

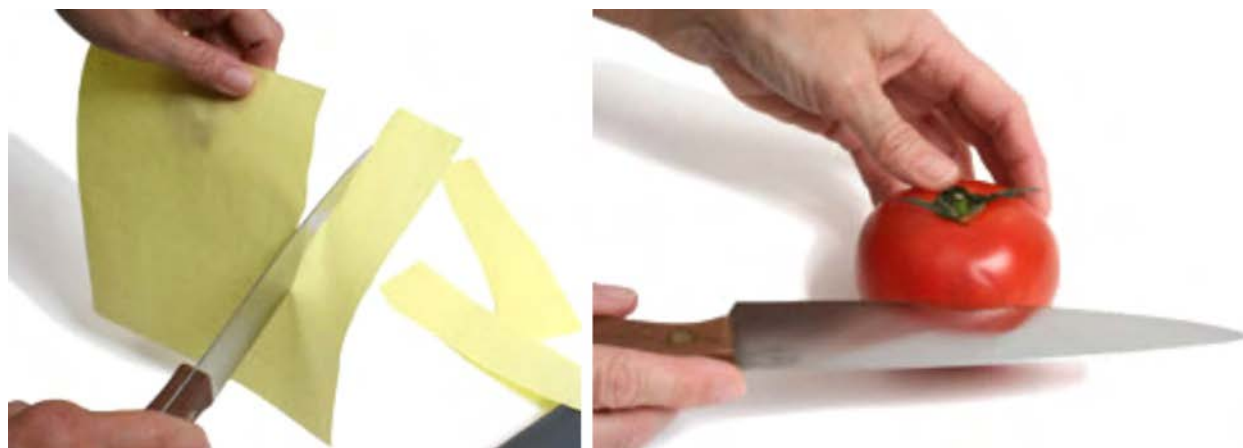

Figure 16 Sharpness Test

Note. From "Recipetips.com", by Types of Kitchen Knives, 2009, *Using a Sharpening Stone*. Copyright 2009 by Tecstra Systems. Retrieved February 27, 2009, from <http://www.recipetips.com/kitchen-tips/t--1075/types-of-kitchen-knives.asp>

8. **Repeat sharpening on both sides, if required, until desired sharpness is achieved.** Using a fine grit stone, grind the blade edge using the same basic method used with a coarser grit stone. Make four or five counter-clockwise strokes across the stone and turn the blade over and make four or five strokes on the other side. Continue to alternate back and forth in this manner until the blade edge is polished and razor sharp. Repeat until the blade develops the desired sharpness.
9. **Clean the survival knife.** As a knife is sharpened, steel is being filed away, leaving shards or filings on the blade. Once the blade has reached the desired sharpness, wipe or rinse the blade. It is important to remove this leftover material to avoid it from splintering the user's hand or getting into food.

After the knife is cleaned, wash the sharpening stone(s) with hot soapy water and brush it to remove all debris. Allow the stone to dry completely before storing.



Although using oil is a plausible option, it is suggested to use water when removing dirt and grime from the stone after sharpening is complete.



Figure 17 Cleaning

Note. From "Recipetips.com", by Types of Kitchen Knives, 2009, *Using a Sharpening Stone*. Copyright 2009 by Tecstra Systems. Retrieved February 27, 2009, from <http://www.recipetips.com/kitchen-tips/t--1075/types-of-kitchen-knives.asp>

CONFIRMATION OF TEACHING POINT 5

The cadets' participation in sharpening a survival knife will serve as the confirmation of this TP.

END OF LESSON CONFIRMATION

The cadets' participation in sharpening a survival knife will serve as the confirmation of this lesson.

CONCLUSION

HOMEWORK / READING / PRACTICE

Nil.

METHOD OF EVALUATION

Nil.

CLOSING STATEMENT

A survival knife is an important tool. It can help to procure food and materials and help build structures in a survival situation. Prolonged use of a knife will eventually wear down the blade, reducing the blade's ability to cut and slice effectively. Being able to sharpen a survival knife will help create materials in a survival situation.

INSTRUCTOR NOTES / REMARKS

This EO shall be conducted prior to the bivouac field training exercise.

The instructor shall remind the cadet to use the survival knife in a safe manner. Caution the cadet when working the blade on a sharpening stone. If it is dark, make sure a source of light is positioned nearby.

REFERENCES

C0-111 ISBN 978-0-9740820-2-8 Tawrell, P. (2006). *Camping and wilderness survival* (2nd ed.). Lebanon, NH: Author.

C2-008 ISBN 0-00-653140-7 Wiseman, J. (1999). *The SAS survival handbook*. Hammersmith, London: HarperCollins Publishers.

C2-225 Fontaine, R. *Survival topics: Your online survival kit!* Retrieved February 11, 2009, from <http://www.survivaltopics.com/survival/how-to-choose-a-survival-knife/>

THIS PAGE INTENTIONALLY LEFT BLANK



ROYAL CANADIAN ARMY CADETS

GOLD STAR

INSTRUCTIONAL GUIDE



SECTION 2

EO M424.02 – EMPLOY THE IMPROVISING PROCESS

Total Time:

30 min

PREPARATION

PRE-LESSON INSTRUCTIONS

Resources needed for the delivery of this lesson are listed in the lesson specification located in A-CR-CCP-704/PG-001, *Gold Star Qualification Standard and Plan*, Chapter 4. Specific uses for said resources are identified throughout the instructional guide within the TP for which they are required.

Review the lesson content and become familiar with the material prior to delivering the lesson.

Select an area that can provide natural items (eg, deadfall, rocks, vines, bushes, cattail, grass) that can be used for improvising.

PRE-LESSON ASSIGNMENT

Nil.

APPROACH

An interactive lecture was chosen for TP 1 to review techniques for survival and to generate interest.

A practical activity was chosen for TP 2 as it is an interactive way to introduce cadets to the improvising process. This activity contributes to the development of survival skills and knowledge in a fun and challenging setting.

INTRODUCTION

REVIEW

Nil.

OBJECTIVES

By the end of this lesson the cadet shall have employed the improvising process.

IMPORTANCE

It is important for cadets to learn how to improvise items when in a survival situation. When a cadet determines they are lost, the ability to stop and inspect their immediate surroundings can provide the necessities to improvise items that will allow them to survive while awaiting help. Improvising items can increase the chances of survival.

Teaching Point 1**Review techniques for survival.**

Time: 5 min

Method: Interactive Lecture



Briefly review the survival techniques cadets have learned throughout the Cadet Program—STOP, five elements of survival and the seven enemies of survival.

These techniques will help guide them in a survival situation when applying the improvising process to determine what items should first be created.

THE STOP PROCEDURE

A person can become lost simply by leaving a tent to go to the washroom or by following an incorrect compass bearing on a hike. Once it is determined that one is lost, the best thing to do is to stay in one place, keep calm and try to gather information to determine one's location. It is extremely important to concentrate on making good decisions.

Sit. Sit where you are! Do not panic. Many lost people waste valuable energy and risk injury by panicking—running aimlessly, continuing to travel after dark, or walking in circles. If a lost person decides to wander in an attempt to find their location, in most cases they will move further away, increasing the distance between the known points of their course. This will only increase the size of the search area, increasing the time it will take for a rescue team to locate an individual. During the first 30 minutes of being lost is when people tend to make their biggest mistakes. Making good decisions about the situation involves thinking through options without panicking.

Think. Think about immediate and future dangers and the factors involved in the situation. Consider the time of day, personal physical condition, and the last time water or food was consumed. Try to list the options that are available.

Observe. Observe and listen for the signals of rescuers. Study the immediate environment, determining weather, terrain and resources available. Check the immediate area for a shelter location, fresh drinking water, and for clues of the current location.

Plan. Plan the best course of action. It could be close to dark and consideration should be given to setting up shelter, finding water or starting a fire. A safety bearing could have been provided prior to beginning the activity and consideration should be given to use it or not. Include in the plan how to signal rescuers.

FIVE ELEMENTS OF SURVIVAL

After successfully completing the STOP action and recognizing a survival situation, the lost individual shall take inventory of all the food and equipment on hand and proceed to implement the five elements of survival. These are listed in order of priority.

Attitude. Maintaining a positive attitude is essential. One can survive by staying calm, using all available resources, and prioritizing personal needs.

Shelter. Designed to provide protection from the weather and, depending on the conditions, protect a person from either hot or cold temperatures. Hypothermia and hyperthermia are two of the greatest dangers in a survival situation. A proper shelter can help prevent these from occurring. In a desert scenario, for example, the goal is to stay under a shelter, shaded from the effects of the sun. In cold weather situations, the shelter will provide insulation.

Water. The most essential nutrient for the human body. Even when thirst is not extreme it can dull your mind. Lack of water will slowly degrade the ability to survive. With adequate shelter and water you can survive for weeks.

Fire. In a survival situation, fire provides heat and light, and signals to rescuers. Cold weather not only lowers the ability to think, but it also lowers one's will to do anything. Even a few degrees drop in body temperature can affect the ability to make reasonable decisions.

Food. Individuals in good physical condition can go for many days or even weeks without food. Your goal in a wilderness survival situation is to be located in the shortest time possible, so in most cases you will be located long before food becomes a survival issue. However it is always important to prepare for the worst and find ways to supply the body with substance, through berries, fish, animals, birds, etc.

SEVEN ENEMIES OF SURVIVAL

Cold. More of a threat than most people think. Cold lowers the ability to think and distracts people from doing much more than thinking about getting warm. Because cold slows the body down, it is easy to feel the need to sleep. Cold numbs the mind, the body and the will. Stay moving to try to get warm.

Pain. Nature's way of letting the mind know that something is wrong. The mind can postpone the feeling of pain, if the mind and body are distracted doing something else. Once the mind recognizes pain, it can weaken the drive to survive. It can become overwhelming, even if it is not serious or prolonged. Keep spirits up to postpone the feeling of pain.

Thirst. The hidden enemy of survival. Even when someone has a mild thirst, the mind can feel dull. Like pain and cold, if attention is drawn to it, it can lower the drive to survive. Remember to drink water if it is available and safe. The feeling of thirst can fog the mind. One can become dehydrated even when water is available because they forget to drink or do not force themselves to drink. Lack of water leads to dehydration as well as headaches and nausea.

Hunger. The feeling of hunger can affect a person's rational thought. Thirst and hunger can increase the chances of weakening to the effects of cold, pain and fear. This is especially true after three days, when the stomach shrinks and reduces its desire for food.

Fatigue. Even a small amount of fatigue (tiredness) can reduce mental ability. It is easy to become lazy and adopt a careless attitude. Fatigue is one of the biggest dangers to wilderness survival and may be responsible for some deaths. Although there is a real danger of over-exertion, fatigue may be caused by a feeling of hopelessness or frustration. Sleep allows someone to escape from a situation they feel may be too difficult to handle.

Boredom and loneliness. Boredom and loneliness are two of the toughest enemies of survival because they are unexpected. When there is nothing to do, feelings of boredom and loneliness may creep up. Try to find some way to keep occupied. Working on a plan allows one to be constructive while staying busy. Building amenities for the site or something as simple as singing and talking can keep the cadet's mind occupied.

CONFIRMATION OF TEACHING POINT 1

QUESTIONS:

- Q1. When stressed about being in a survival situation, what do some people forget to use?
- Q2. What are the seven enemies of survival?
- Q3. What are the five elements of survival?

ANTICIPATED ANSWERS:

- A1. When stressed about being in a survival situation, some people forget to use their common sense.
- A2. The seven enemies of survival are cold, pain, thirst, hunger, fatigue and boredom and loneliness.
- A3. The five elements of survival are attitude, shelter, water, fire and food.

Teaching Point 2

Conduct a scenario-based activity where the cadets will employ the improvising process.

Time: 20 min

Method: Practical Activity

BACKGROUND KNOWLEDGE

IMPROVISING PROCESS

Being lost and unaware of one's surroundings can be an uncomfortable and scary situation. It can happen at any time. Even when leaving a campsite to go to the washroom, a person can easily take a wrong turn and find themselves wandering aimlessly in the forest. Improvising can turn an uncomfortable survival situation into one that is more comfortable. With creativity and imagination, anyone can improvise the basic survival necessities, gather food, make shelter and create a source of heat. The only limiting factor is the imagination. This is all possible, it just requires the person to stop, think and follow the improvising process. When working through the improvising process, the following steps will help in making the best choices:

1. **Determine items needed for survival.** When in a survival situation, determine what is required to survive from the most to least important (eg, shelter, food, fire, water).
2. **Identify available resources.** Take inventory of available resources, to include two types of materials—natural and man-made. Man-made items can be anything from a survival knife to the laces in footwear and even the clothes on oneself. Natural items include resources found in the area such as trees, branches, leaves, cattails, etc.
3. **Consider options available.** Think about that what options are available to meet the needs of the situation by remembering the five elements of survival and determining priorities. If there is an injury, the first thing would be to tend to the wound, (eg, a broken or sprained ankle may need to be splinted) to allow one to continue about the site.
4. **Select a survival item to improvise.** Particular factors determine the practicality of an item to improvise. The factors that influence the type of survival item to be improvised include:
 - a. **Time.** How much time will be consumed constructing the item? Time is important to survival. As time passes the remaining hours of sunlight diminish. If time is assessed correctly, many improvised items can be created to help prolong survival until help arrives. In the big picture, if an item will take a considerable amount of time to construct, the question needs to be asked: will this benefit the situation?
 - b. **Energy.** Will the item benefit the situation if a lot of energy was expended creating it? Choosing to construct an item that consumes considerable amounts of energy without having a source of food to replenish that energy can threaten the chances of survival.
 - c. **Materials.** Will the item require man-made or natural materials? These materials may be limited depending on area. Could the materials be put to better use and are the materials being used in an appropriate fashion? This must be considered.

5. **Construct the survival item.** Once it is determined that the item is viable and required, the person can continue with the construction, ensuring that the final product is safe and durable.



Some survival items do not need to be constructed (eg, using a rock as a hammer).

6. **Repeating the process for other survival items.** The process can be repeated to create more survival items. This should continue until found; an idle mind can be devastating to survival.



Items that are common to improvise include:

- bed / layer of comfortable material to rest on,
- cordage,
- cutlery,
- shelters,
- tools,
- traps,
- water carrying devices,
- weapons for hunting, and
- wind and heat reflectors.

ACTIVITY

Time: 20 min

OBJECTIVE

The objective of this activity is to have the cadets employ the improvising process.

RESOURCES

- Natural and man-made items found in the surrounding area, and
- River Folly scenario located at Attachment A.

ACTIVITY LAYOUT

Nil.

ACTIVITY INSTRUCTIONS

1. Conduct a briefing to include an explanation of:
 - a. the objectives and importance of the activity,
 - b. the resources that may be required to perform the activity, and
 - c. any safety guidelines that must be followed while performing the activity.

2. Divide the cadets into pairs.
3. Read the River Folly scenario located at Attachment A to the cadets.
4. In pairs, based on the scenario, have the cadets:
 - a. determine items needed for survival from most to least important;
 - b. identify available resources in the immediate area, to include:
 - (1) man-made, and
 - (2) natural;
 - c. consider options available by:
 - (1) referring to the five elements of survival,
 - (2) determining what should be improvised first to assist the survival situation;
 - d. select a survival item to improvise;
 - e. construct the survival item if time permits; and
 - f. repeat the process for other survival items.
5. Conduct a debriefing of the activity.



The items improvised should be small and simple given the amount of time available.

SAFETY

Cadets shall be briefed on any boundaries for this activity.

CONFIRMATION OF TEACHING POINT 2

The cadets' participation in the improvising activity will serve as the confirmation of this TP.

END OF LESSON CONFIRMATION

The cadets' participation in the improvising activity will serve as the confirmation of this lesson.

CONCLUSION

HOMEWORK / READING / PRACTICE

Nil.

METHOD OF EVALUATION

Nil.

CLOSING STATEMENT

The improvising process is a method a person can use to help determine a requirement and provide basic constructed materials to aid in a survival situation. This process allows the one to weigh the pros and cons of a particular item before committing materials and resources. Creating improvised items can increase the chances of survival.

INSTRUCTOR NOTES / REMARKS

This EO shall be conducted during the allocated bivouac field training exercise.

REFERENCES

C2-016 ISBN 0-517-88783-5 Curtis, R. (1998). *The backpacker's field manual: A comprehensive guide to mastering backcountry skills*. New York, NY: Three Rivers Press.

C2-148 ISBN 978-0-8117-3292-5 Davenport, G. (2006). *Wilderness survival*. Mechanicsburg, PA: Stackpole Books.

THIS PAGE INTENTIONALLY LEFT BLANK

RIVER FOLLY

The cadet corps has planned a three-day canoe trip for senior cadets. The trip covers a total distance of 53 km and includes travel across many lakes, including portages and some white water canoeing. It is late August, the weather at this time of year has normal daytime temperatures between 18–23 degrees Celsius and temperatures overnight between 8–13 degrees Celsius.

It is Day Two, early afternoon of the canoe trip and the group has travelled by canoe on flatwater. The final leg of the day takes the group down a fast moving river with a few Class 2 rapids. The group is required to travel 2 km down the river and complete a final portage to that evening's campsite. All groups are directed to follow the lead canoe, giving ample distance between canoes in case of accidental capsizing.

You and your partner are the third canoe in the chain. As you follow the lead canoes ahead, you see they are turning and rafting in an eddy. Just past the eddy is what appears to be an area of Class 3 rapids—larger rapids than what this group expected today. As you approach the lead canoes, you are directed to raft up in the eddy. However, when turning into the eddy something goes wrong. You feel a sudden rush of cold water engulf your body and you are stunned, as the rushing current pulls you downstream.

You awaken face down on a small rocky beach, pebbles are in your mouth, your face is covered in mud and half your body is still in the water. You feel a slight headache and have a rather sizable lump on your forehead. You instantly assume you must have been knocked unconscious when the canoe capsized and have no idea where you are on the river. You remember in the briefing the instructor informed everyone that this river is over a 100 km long and runs directly into the ocean—you could be anywhere.

Climbing out of the river and to higher ground, you gather your thoughts and assess the situation. You realize you are only left with your personal flotation device (PFD), a wet suit and a knife on your belt. Everything else is missing, including your shoes, helmet and survival kit.

Thinking back to your training, you remember that stern looking warrant officer teaching you about survival factors who told you that if you get lost the first thing you should consider are the techniques for survival including STOP, five elements of survival and the seven enemies of survival.

Well you are lost, you are wet, you have a headache and it is going to be dark in four or five hours. What items can you improvise to help you survive the night while you wait for help?

Scan the surrounding area to see what available natural resources may be employed.

THIS PAGE INTENTIONALLY LEFT BLANK



ROYAL CANADIAN ARMY CADETS
GOLD STAR
INSTRUCTIONAL GUIDE



SECTION 3

EO M424.03 – WEAVE CORDAGE

Total Time:

90 min

PREPARATION

PRE-LESSON INSTRUCTIONS

Resources needed for the delivery of this lesson are listed in the lesson specification located in A-CR-CCP-704/PG-001, *Gold Star Qualification Standard and Plan*, Chapter 4. Specific uses for said resources are identified throughout the instructional guide within the TP for which they are required.

Review the lesson content and become familiar with the material prior to delivering the lesson.

Information on types of trees can be found in A-CR-CCP-702/PF-001, *Red Star Instructional Guides*, EO C221.03 (Identify Species of Trees).

Conduct a reconnaissance of the area being used for the lesson and identify cordage materials in the area.

An assistant instructor may be required for TPs 3–5.

PRE-LESSON ASSIGNMENT

Nil.

APPROACH

An interactive lecture was chosen for TPs 1 and 2 as it introduces the cadet to the characteristics and many uses of cordage.

A demonstration and performance was chosen for TPs 3–5 as it allows the instructor to explain and demonstrate making and weaving cordage while providing an opportunity for the cadet to practice this skill under supervision.

INTRODUCTION

REVIEW

The review for this lesson is from EO M424.02 (Employ the Improvising Process).

QUESTIONS:

- Q1. What are the seven enemies of survival?
- Q2. Why are boredom and loneliness two of the toughest enemies of survival?
- Q3. What enemy has a greater impact on a person's ability to survive, thirst or hunger?

ANTICIPATED ANSWERS:

- A1. The seven enemies of survival are pain, cold, thirst, hunger, fatigue, boredom and loneliness.
- A2. Boredom and loneliness are two of the toughest enemies of survival because they are often unexpected and can creep up on a person.
- A3. A person can live without food longer than they can live without water. Dehydration can kill within a couple of days.

OBJECTIVES

By the end of this lesson the cadet shall have weaved cordage from raw materials.

IMPORTANCE

It is important for cadets to be able to weave cordage from natural resources. Possessing this skill makes it easier for the cadet to survive in a survival situation. Cordage has multiple uses that can assist the cadet with combating the seven enemies of survival.

Teaching Point 1**Identify the uses of cordage.**

Time: 5 min

Method: Interactive Lecture



Cordage (cord). A long thin flexible material made from several twisted strands—usually thicker than string and finer than rope.



The purpose of this TP is to introduce the cadets to the different ways that cordage can be used.

Brainstorming is a method that can be used to present this material, as cadets will have some previous knowledge of the topic.

If brainstorming, the following questions could be asked:

1. What is cordage?
2. How can cordage be used in a survival situation?

Brainstorming works best if one cadet is assigned to write the other cadets' responses on flip chart paper.

Cordage may be used in many different ways to combat the seven enemies of survival.

USES FOR CORDAGE

One of the most indispensable items in a survival situation is cordage. Some of its common uses include:

- lashing materials together;
- binding materials;
- making snares;
- hanging food;
- hanging items;
- constructing water carrying devices;
- making shelter;
- constructing clothing; and
- sewing items together.

CONFIRMATION OF TEACHING POINT 1**QUESTIONS:**

- Q1. What is cordage?
- Q2. What are three uses for cordage that will assist an individual to combat hunger?
- Q3. How would cordage be used when making shelter?

ANTICIPATED ANSWERS:

- A1. Cordage (cord) is a long thin flexible material made from several twisted strands—usually thicker than string and finer than rope.
- A2. The following uses of cordage will assist an individual in combating hunger:
- making snares;
 - hanging food; and
 - constructing water carrying devices.
- A3. When making shelter, cordage may be used to lash and bind materials together.

Teaching Point 2

Identify the characteristics of cordage materials.

Time: 5 min

Method: Interactive Lecture



The purpose of this TP is to introduce cadets to the characteristics of cordage. Remind cadets of the two types of rope—natural and synthetic.

Have examples of cordage to assist in explaining the characteristics.

Cordage may be used in a multitude of ways. It is important to ensure that the materials selected meet some basic characteristics. This makes it easier to construct the cordage and to ensure that the final product is of high quality.

CHARACTERISTICS OF CORDAGE MATERIALS

The following characteristics must be considered when selecting cordage materials:

Length of the fibre. The longer the fibre being used, the easier it is to work with. Longer fibres also make cordage stronger as there are fewer weak areas in the cordage where smaller pieces are joined together.

Strength of the fibre. The fibres must be strong enough that they may be pulled apart without breaking. This ensures that when the cordage is being constructed, pieces do not break apart.

Pliability of the fibre. The fibre should be pliable enough to be tied into a knot without breaking.



Pliable. Bending easily / supple.

Availability of grip on the fibre. To assist with making cordage, the fibre should have some grip that allows it to bite into (dig into) other pieces when twisted together. This grip may be caused by ridges on the surface, jagged edges, etc.



The stronger the fibre, the stronger the cordage will be. Some stiff fibres, such as vines, may be made more pliable by steaming or warming them in warm water.

CONFIRMATION OF TEACHING POINT 2**QUESTIONS:**

- Q1. What are the four characteristics that must be considered when selecting cordage materials?
- Q2. What happens if the fibre is short?
- Q3. How is the pliability of a piece of fibre assessed?

ANTICIPATED ANSWERS:

- A1. The four characteristics that must be considered when selecting cordage materials are:
- length of the fibre,
 - strength of the fibre,
 - pliability of the fibre, and
 - availability of grip on the fibre.
- A2. If the fibre is short, it is difficult to work the fibre into cordage and it may make the cordage weak due to the number of smaller pieces used.
- A3. The pliability of a piece of fibre is assessed by tying it into a knot. If it ties into a knot, then it is pliable.

Teaching Point 3

Explain, demonstrate and have the cadets select cordage materials.

Time: 20 min

Method: Demonstration and Performance



For this TP, it is recommended that instruction take the following format:

1. Introduce the cadets to the five types of materials that can be used to make cordage.
2. Give cadets a guided tour of the area to show them examples of the materials that are available in the general area.
3. Have the cadets select and gather cordage materials for use in TPs 4 and 5 (they only need one type, [eg, tree bark]).
4. Demonstrate how to prepare the following types of cordage materials:
 - a. tree bark,
 - b. stalks from pithy plants,
 - c. leaves,
 - d. roots, and
 - e. grasses.

5. Have the cadets prepare the cordage materials selected for use in TPs 4 and 5.

Have cadets select cordage materials that require little preparation. There is no time for soaking and drying.

Note. If using an area that does not have enough materials available, cadets may be grouped into pairs or groups of three.

It is important to understand that it is not the actual raw material—bark, root, vine—that makes it a good selection for making cordage. It is the fibres that make up / come from that piece of raw material.



Think about the fabric that makes up a silk shirt. The fabric is constructed from hundreds of silk fibres that are woven together to make string. The pieces of string are constructed from the leaves of a silk plant that have been separated.

CORDAGE MATERIALS

The following is a list of raw materials that can be used to make cordage:

- trees,
- stalks,
- leaves,
- roots, and
- miscellaneous materials, to include:
 - rushes / sedges / grasses,
 - animal sinew, and
 - animal hair.

Trees

The dried inner bark of just about any tree supplies workable material to construct cordage. Some of the best bark comes from the following trees:

- basswood,
- elm,
- walnut,
- cherry,
- aspen,
- cottonwood,
- maple, and
- cedar.

When collecting bark to use for cordage, it is best to look for dead, rather than live trees. The fibrous, inner bark should be pulled off the dead tree in strips that are as long as possible. If there are no dead trees in the area, live trees can be used by stripping the inner bark off the tree and then letting it dry out before use.



Figure 1 Bark Fibres

Note. From "Wildwood Survival", *Cordage*, Copyright 2008 by Walter Muma. Retrieved April 23, 2009, from <http://www.wildwoodsurvival.com/survival/cordage/basswood/index.html>



If a tree has been down a long time, it may have decayed. Test the fibres to ensure they are not too brittle.

Stalks

The dried inner portion of the stalk of fibrous plants can also be useful in making cordage. Examples include:

- dogbane,
- milkweed,
- velvet leaf,
- wild hemp,
- evening primrose,
- stinging nettles,
- fireweed,
- sagebrush,
- thistle, and
- yucca.

When using stalks to make cordage, the fibrous material can be extracted:



A pithy plant has a spongy inner core, while a non-pithy plant has a hard inner core.

- from pithy plants (eg, dogbane, milkweed, thistle) by pulling off the outside of the stalk in long ribbons (when wet) or when dry by crushing and opening up the stalk, breaking off sections of the woody inner core to get long ribbons of fibres; and



Figure 2 Pulling off the Outside Stalk of a Dogbane

Note. From "Wildwood Survival", *Cordage*, Copyright 2008 by Walter Muma. Retrieved April 23, 2009, from <http://www.wildwoodsurvival.com/survival/cordage/dogbane/index.html>

- from non-pithy (eg, nettles) plants by soaking the long stems in water for 24 hours, laying them on a piece of wood, pounding them with a smooth stone to shred the outer surface, exposing the fibrous centre and drying the fibrous centre.



Figure 3 Extracting Fibres From the Yucca Stalk

Note. From "Wildwood Survival", *Cordage*, Copyright 2008 by Walter Muma. Retrieved April 23, 2009, from <http://www.wildwoodsurvival.com/survival/cordage/syucca/index.html>



When selecting plants, look for ones that grow very tall. This makes constructing cordage from the collected fibrous material much easier.

Leaves

The leaves of some plants / trees are very fibrous and may be used to make cordage. Examples include the:

- lily,
- aloe,
- palm,
- cattails, and
- yucca.

When using leaves to make cordage, it is important that the leaves are soaked to remove the flesh, however, leave the fibrous portion.



A leaf may be tested to see if it is fibrous by tearing it apart to see if it separates into stringy layers.

Roots

The surface roots of many trees can be used to make very strong cordage. Roots that run just above or just under the surface of the ground are often the most pliable and strong. The thinner the root, the better it is. Examples of trees with good roots are:

- cedar,
- pine,
- juniper,

- tamarack, and
- spruce.



It is best to gather roots from dead trees. If this is not possible, cut only small sections of root from a variety of trees in the area. This limits damage to trees.



Figure 4 Roots

Note. From "Wildwood Survival", *Cordage*, Copyright 2008 by Walter Muma. Retrieved April 23, 2009, from <http://www.wildwoodsurvival.com/survival/cordage/roots/index.html>

Miscellaneous Materials

There are a number of other sources of fibrous materials to make cordage. They include:

Rushes / sedges / grasses. These types of items can be found anywhere. They should be used while still green and it is important to remember that as they dry out, their strength diminishes. When selecting rushes, sedges and grasses, choose the longest pieces first.



A sedge is a grasslike plant that grows in wet areas.

Animal sinew. Animal sinew (tendons, ligaments) can be used to create exceptionally strong cordage. The longest sinew is found in the white cords that run along either side of an animal's backbone or attached to muscles and bones. The sinew is cut out, removed from its protective sheath, cleaned, dried, separated into fibres and then placed in hot water just before use to make it pliable.

Animal hair. Animal hair provides an excellent and easy to use source for making cordage—if it can be found. Large amounts, the longer the better, are required to ensure the cordage is strong. Animal hair can be found on trees, the ground and on the carcass of a dead animals.

CONFIRMATION OF TEACHING POINT 3

The cadets' selecting of cordage material will serve as the confirmation of this TP.

Teaching Point 4

Explain, demonstrate and have the cadet construct cordage from the selected materials by wrapping the raw materials into a 1-m (3-foot) long continuous cord.

Time: 20 min

Method: Demonstration and Performance



For this TP, it is recommended that instruction take the following format:

1. Explain and demonstrate constructing cordage from selected materials into continuous cord while the cadets observe.
2. Explain, demonstrate and have the cadets complete each step to construct cordage from selected materials into a 1-m (3-foot) long continuous cord.

Note: Assistant instructors may be required.

The first step in making cordage is to wrap the raw materials that have been gathered into long single strands. To do this:

1. Collect and prepare raw materials, as required (completed in TP 3).

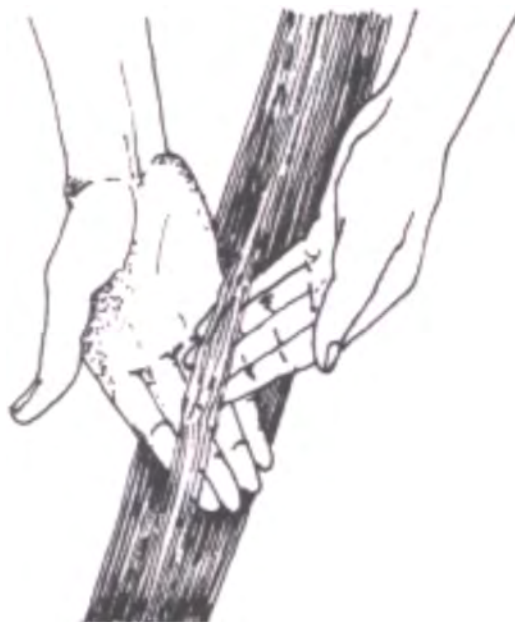

Figure 5 Collecting Raw Materials

Note. From *Tom Brown's Field Guide: Wilderness Survival* (p. 245), by T. Brown, Jr., and Morgan, B., 1983, New York, NY: Berkley Publishing Group. Copyright 1983 by Tom Brown, Jr.



It is important to ensure the raw material is broken down completely and as much of the fibre as possible is separated from the non-fibrous materials. This can be done by rolling the raw material between the palms of the hands.

2. Decide on the desired width and length of the cordage to be constructed.



For this TP cadets will be required to construct a 1-m (3-foot) long continuous cord.

3. Collect the required amount of raw materials to achieve the width and length desired.
4. Select a bundle of fibres (enough to cover the palm of the hand).



A larger bundle of fibres will not necessarily make the piece of cordage stronger. Stronger cordage is made by combining multiple pieces of wrapped strands.

5. Place the bundle on the top of the upper thigh.
6. Roll the bundle on the thigh, in one direction, using the palm of the hand to wrap the fibres.



Figure 6 Rolling Fibres on the Thigh

Note. From "Wildwood Survival", *Cordage*, Copyright 2008 by Walter Muma. Retrieved April 23, 2009, from <http://www.wildwoodsurvival.com/survival/cordage/men79/index.html>



It is sometimes easier to wrap fibres when the thigh is damp.

7. Add additional fibres, in small staggered bundles, to one end by spreading and fitting the fibres into each other to create a continuous piece of cordage the desired length.



The rolling wraps the fibres together. The staggering of the new fibres ensures they bind at different intervals along the piece of cordage—making it stronger.

CONFIRMATION OF TEACHING POINT 4

The cadets' construction of a piece of cordage will serve as the confirmation of this TP.

Teaching Point 5

Explain, demonstrate and have the cadet weave cordage into a 0.5-m (1.5-foot) one-strand braid (simple wrap).

Time: 30 min

Method: Demonstration and Performance



For this TP, it is recommended that instruction take the following format:

1. Explain and demonstrate weaving cordage into a 0.5-m (1.5-foot) one-strand braid while the cadets observe.
2. Explain, demonstrate and have the cadets complete each step to weave cordage into a 0.5-m (1.5-foot) one-strand braid.

Note: Assistant instructors may be required.

Once the piece(s) of long continuous cordage has been constructed, the next step in the process is to weave the cordage together. There are multiple ways to weave cordage together—the more strands that are weaved together, the stronger the end product is going to be. The chosen method of weaving will therefore depend on what the cordage is going to be used for. The following weaves, in order of strength with strongest being listed last, can be completed:

- one-strand braid (simple wrap),
- two-strand braid (reverse wrap),
- three-strand braid, and
- four-strand braid.

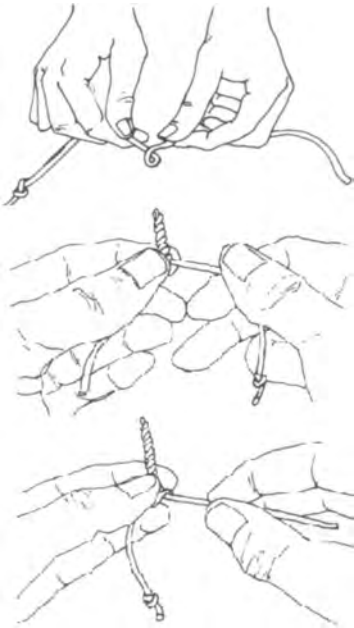

Figure 7 Two-Strand Braid (Reverse Wrap)

Note. From *Tom Brown's Field Guide: Wilderness Survival* (p. 243), by T. Brown, Jr., and Morgan, B., 1983, New York, NY: Berkley Publishing Group. Copyright 1983 by Tom Brown, Jr.

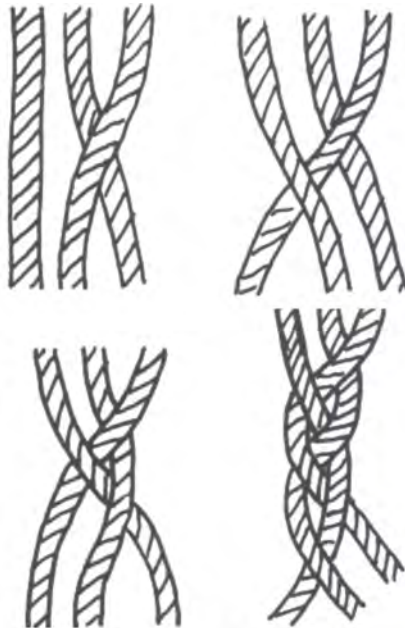

Figure 8 Three-Strand Braid

Note. From *Wilderness Survival* (p. 271), by J. Davenport, 2006, Mechanicsburg, PA: Stackpole Books. Copyright 2006 by Gregory J. Davenport.

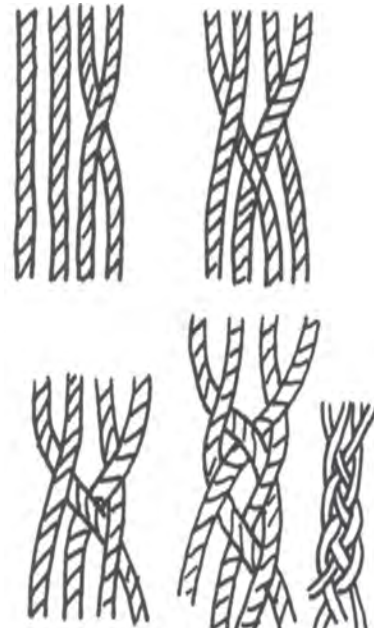



Figure 9 Four-Strand Braid

Note. From *Wilderness Survival* (p. 272), by J. Davenport, 2006, Mechanicsburg, PA: Stackpole Books. Copyright 2006 by Gregory J. Davenport.

The one-strand braid (single wrap) is a quick and easy way to weave cordage that can be used in many different applications where strength is not the primary concern. To execute a one-strand braid (single wrap) use the following process:

1. Hold one end of the cordage between the thumb and forefinger of the non-dominant hand.
2. Roll the cordage with the palm of the dominant hand in one direction on the thigh until tight.

 Steps 1 and 2 are the same as Steps 5 and 6 in constructing cordage.

3. Grasp the other end of the cordage.
4. Place the middle of the cordage between the teeth.



Figure 10 Placing Middle of Cordage Between Teeth

Note. From *Tom Brown's Field Guide: Wilderness Survival* (p. 245), by T. Brown, Jr., and Morgan, B., 1983, New York, NY: Berkley Publishing Group. Copyright 1983 by Tom Brown, Jr.



It is important to ensure that cordage being used was not constructed from poisonous raw materials when placing cordage into mouth.

5. Bring both ends of the cordage tightly together.
6. Hold the ends of the cordage tightly together in one hand.
7. Release the doubled cordage from between the teeth to create the braid (wrap).



Releasing the cordage allows for it to naturally twist around itself to form the braid.

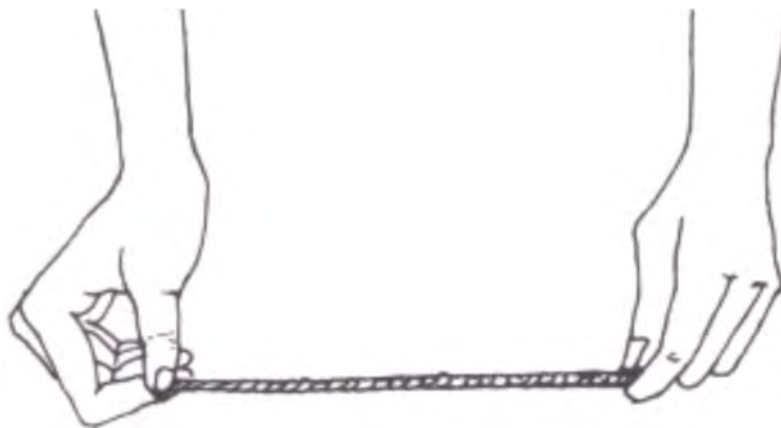

Figure 11 Doubled Cordage

Note. From *Tom Brown's Field Guide: Wilderness Survival* (p. 245), by T. Brown, Jr., and Morgan, B., 1983, New York, NY: Berkley Publishing Group. Copyright 1983 by Tom Brown, Jr.

8. Tighten the braid (wrap) by twisting it and adjusting the cordage.



Figure 12 Example of Good Braid (Top) and Bad Braid (Bottom)

Note. From *Wilderness Survival* (p. 270), by J. Davenport, 2006, Mechanicsburg, PA: Stackpole Books. Copyright 2006 by Gregory J. Davenport.

9. Tie an overhand knot at the end of the cordage.



Once the braid (wrap) is completed, the length of the cordage has shrunk by at least half. This must be taken into consideration to ensure the length of the final product meets what is required.



Figure 13 Examples of Completed Cordage—Burdock and Hemp

Note. From "Wildwood Survival", *Cordage*, Copyright 2008 by Walter Muma. Retrieved April 23, 2009, from <http://www.wildwoodsurvival.com/survival/cordage/finishedcordage.html>

CONFIRMATION OF TEACHING POINT 5

The cadets' weaving of a piece of cordage will serve as the confirmation of this TP.

END OF LESSON CONFIRMATION

The cadets' weaving of cordage will serve as the confirmation of this lesson.

CONCLUSION

HOMEWORK / READING / PRACTICE

Nil.

METHOD OF EVALUATION

This lesson is assessed IAW A-CR-CCP-704/PG-001, *Gold Star Qualification Standard and Plan*, Chapter 3, Annex B, 424 PC.

CLOSING STATEMENT

Being able to weave cordage from raw materials is a skill that will assist a cadet in survival when lost. Cordage may be used in so many different ways, that it is an integral item to have in a survival situation. Applying this skill assists in combating the seven enemies of survival.

INSTRUCTOR NOTES / REMARKS

Select an area where the raw materials required for this EO may be found. If that is not possible, gather enough raw materials, for each cadet, from an alternate location and bring them to the area.

REFERENCES

C2-008 ISBN 0-00-653140-7 Wiseman, J. (1999). *The SAS survival handbook*. Hammersmith, London: HarperCollins Publishers.

C2-068 ISBN 0-425-10572-5 Brown, T., Jr., & Morgan, B. (1983). *Tom Brown's field guide: Wilderness survival*. New York, NY: The Berkley Publishing Group.

C2-148 ISBN 978-0-8117-3292-5 Davenport, G. (2006). *Wilderness survival*. Mechanicsburg, PA: Stackpole Books.

THIS PAGE INTENTIONALLY LEFT BLANK



ROYAL CANADIAN ARMY CADETS
GOLD STAR
INSTRUCTIONAL GUIDE



SECTION 4

EO C424.01 – WHITTLE WOOD

Total Time:

90 min

PREPARATION

PRE-LESSON INSTRUCTIONS

Resources needed for the delivery of this lesson are listed in the lesson specification located in A-CR-CCP-704/PG-001, *Gold Star Qualification Standard and Plan*, Chapter 4. Specific uses for said resources are identified throughout the instructional guide within the TP for which they are required.

Review the lesson content and become familiar with the material prior to delivering the lesson.

Select an area where natural resources for whittling wood may be found.

Collect sticks that are 11–12 cm long for each cadet.

Collect branches and complete Step 1 on the Whittle a Whistle handout located at Attachment A for each cadet.

PRE-LESSON ASSIGNMENT

Nil

APPROACH

An interactive lecture was chosen for TPs 1 and 3 as it introduces the cadet to the craft of whittling wood using a survival knife.

A group discussion was chosen for TP 2 as it allows the cadet to interact with their peers and share their knowledge, experiences, opinions and feelings on the many survival items that may be crafted by whittling wood using a survival knife. Sharing in the discussion encourages the cadet to examine their own thoughts and may prompt them to re-think their previously held ideas. Participating in a group discussion improves the cadet's listening skills and team development.

A practical activity was chosen for TP 4 as it is an interactive way to allow the cadet to whittle wood in a safe and controlled environment. This activity contributes to the development of survival skills and knowledge in a fun and challenging setting.

INTRODUCTION

REVIEW

Nil.

OBJECTIVES

By the end of this lesson the cadet shall have whittled wood.

IMPORTANCE

It is important for cadets to whittle wood so they can learn how to manipulate a survival knife to create useful items. Whittling wood can help a cadet procure food, water and shelter in a survival situation. Whittling wood also keeps the mind occupied while being alone in an environment awaiting rescue.

Teaching Point 1**Define whittling.**

Time: 5 min

Method: Interactive Lecture



To engage the cadets and develop an interest in the topic, present the cadets with the following questions:

1. What is whittling?
2. Who has whittled before? What did you whittle?

WHITTLING

Whittling is described as the art of changing the shape of a piece of wood with the removal of shavings or the cutting of small amounts of wood using a knife or small wedge-edged tool.

To whittle wood:

- hold the survival knife in the dominant hand;
- secure the piece of wood with the non-dominant arm;
- make small precise strokes to remove excess wood and shape the object; and
- adhere to safe knife usage.

Whittling requires no special tools, no special circumstance or any specific type of working environment; just a piece of wood and a knife. True whittling is very simple, the objects are very easily identified, as the knife strokes are plainly visible.

Materials used to whittle are small branches or twigs; however, depending on the size of the item that is desired, a larger piece of wood may be required.



If immediate access to good branches for whittling are unavailable, milled scraps of wood are a fine alternative. Make sure the milled lumber is straight-grained, without knots.

CONFIRMATION OF TEACHING POINT 1**QUESTIONS:**

- Q1. Define whittling.
- Q2. What tools are required to whittle wood?
- Q3. What is the main raw material used to whittle?

ANTICIPATED ANSWERS:

- A1. Whittling is described as the art of changing the shape of a piece of wood with the removal of shavings or the cutting of small amounts by using a knife or smaller wedge-edged tool.
- A2. Whittling does not require any special tools. All that is required is a piece of wood and a knife.
- A3. The main raw material to whittle is wood.

Teaching Point 2

Discuss items that can be whittled out of wood.

Time: 10 min

Method: Group Discussion



The point of the group discussion is to draw the following information from the group using the tips for answering / facilitating discussion and the suggested questions provided.

BACKGROUND KNOWLEDGE

ITEMS THAT CAN BE WHITTLED OUT OF WOOD

There are a number of items that can be whittled out of wood. Imagination and determination are the driving forces and the ideas one comes up with are only limited to a persons creativity. When lost, many items can be created with the survival knife to help with survival. Items that can be whittled out of wood include:

- a walking stick,
- a splint,
- a hunting spear,
- a sling shot,
- a fire poker,
- a whistle, and
- utensils, such as:
 - spoon,
 - spreader,
 - fork, and
 - knife.



TIPS FOR ANSWERING / FACILITATING DISCUSSION:

- Establish ground rules for discussion, eg, everyone should listen respectfully; don't interrupt; only one person speaks at a time; no one's ideas should be made fun of; you can disagree with ideas but not with the person; try to understand others as much as you hope they understand you; etc.
- Sit the group in a circle, making sure all cadets can be seen by everyone else.
- Ask questions that will provoke thought; in other words avoid questions with yes or no answers.
- Manage time by ensuring the cadets stay on topic.
- Listen and respond in a way that indicates you have heard and understood the cadet. This can be done by paraphrasing their ideas.
- Give the cadets time to respond to your questions.
- Ensure every cadet has an opportunity to participate. One option is to go around the group and have each cadet answer the question with a short answer. Cadets must also have the option to pass if they wish.
- Additional questions should be prepared ahead of time.

SUGGESTED QUESTIONS:

- Q1. What purpose does whittling serve in a survival situation?
- Q2. What items do you think could be whittled out of wood?
- Q3. Of those items considered, what items do you think could be beneficial in a survival situation?



Other questions and answers will develop throughout the group discussion. The group discussion should not be limited to only those suggested.



Reinforce those answers given and comments made during the group discussion, ensuring the teaching points have been covered.

CONFIRMATION OF TEACHING POINT 2

The cadets' participation in the group discussion will serve as the confirmation of this TP.

Teaching Point 3

Explain how to whittle wood using a survival knife.

Time: 10 min

Method: Interactive Lecture



Before a cadet can whittle an item, they must first learn how to perform basic cutting strokes.



For basic cutting strokes it is recommended that instruction take the following format:

1. Explain and demonstrate the basic cutting strokes.
2. Explain and demonstrate each step required to complete the strokes.
3. Monitor the cadets' performance as they practice each stroke.

Note: Assistant instructors may be used to monitor the cadets' performance and safety.

IDENTIFY BASIC CUTTING STROKES

The following are ways to cut with a knife:

Straightaway cut. Good for removing a lot of wood or bark quickly. Hold the wood in the non-dominant hand, and using long, firm strokes, cut away from the body with the dominant hand. The dominant hand wrist is locked, and does not bend during the stroke.



Figure 1 Straightaway Cut

Note. Created by Director Cadets 3, 2009, Ottawa, ON: Department of National Defence.

Draw cut. Involves placing the wood in the non-dominant hand and the knife in the dominant hand. Cut toward the body (similar to peeling an apple) with short strokes, using the dominant hand thumb as a brace against the wood. Be sure to keep some wood between the blade and the thumb. It is safer to keep the dominant hand thumb braced on the other thumb, not on top of the wood itself. This decreases the risk of the blade moving into the thumb on its follow-through when it clears the wood.

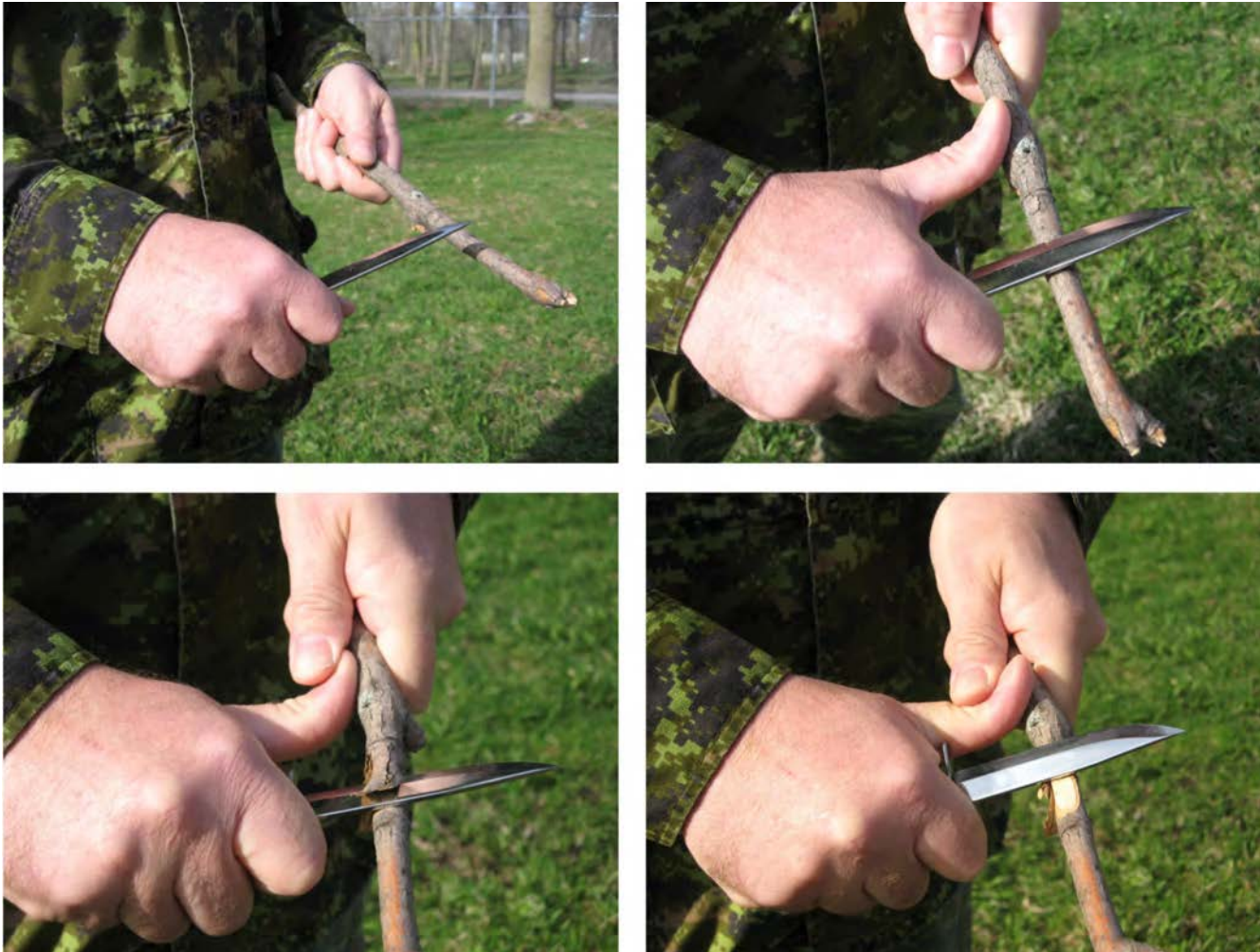

Figure 2 Draw Cut

Note. Created by Director Cadets 3, 2009, Ottawa, ON: Department of National Defence.

Thumb push. Practical for small cuts where precise control is needed and limited cutting is required. Hold the wood in the four fingers of the non-dominant hand, leaving the thumb free. Grip the knife in the dominant hand, keeping the thumb against the back of the blade. With the non-dominant hand thumb, push either the back of the blade or the back of the dominant hand thumb.

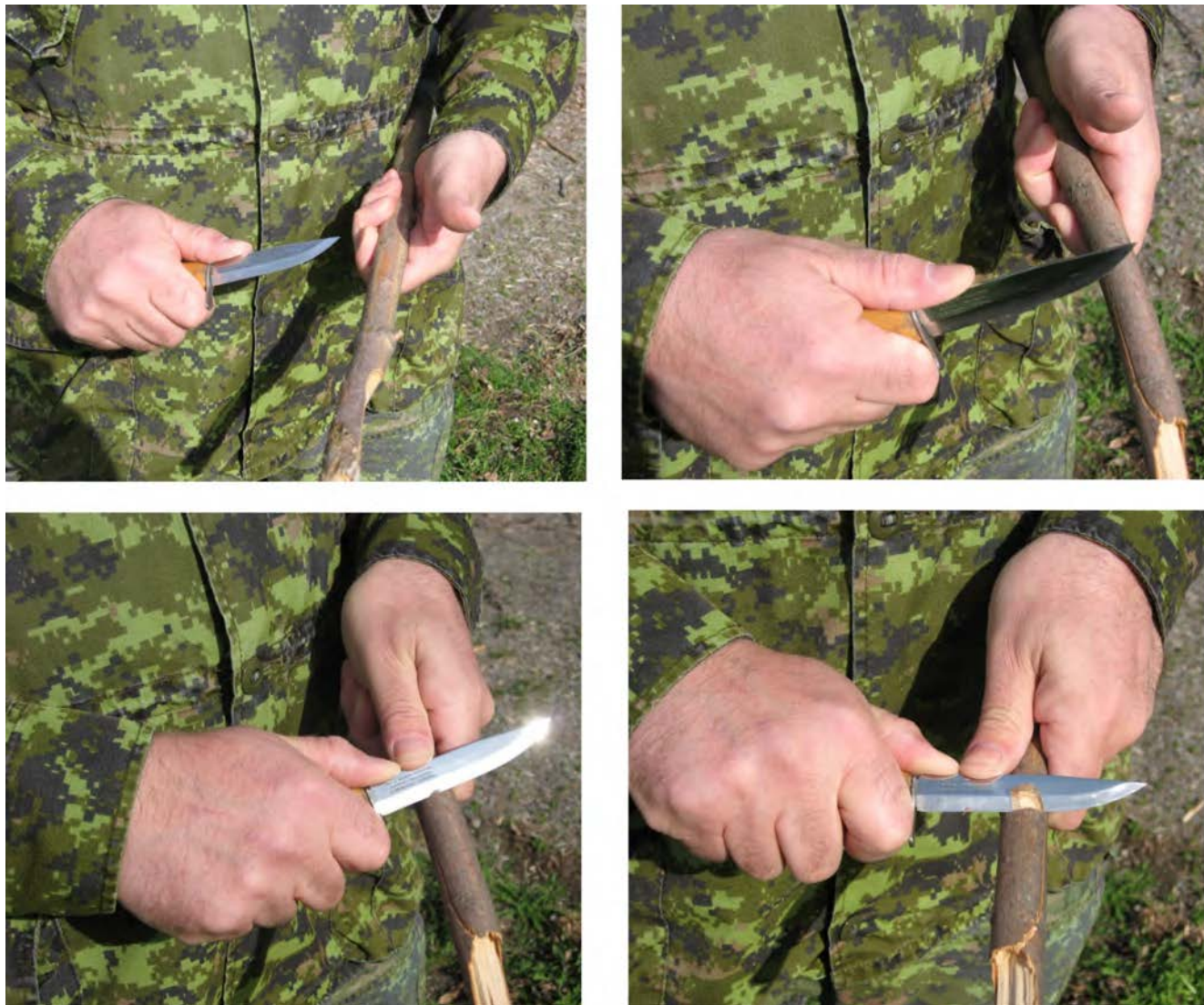

Figure 3 Thumb Push

Note. Created by Director Cadets 3, 2009, Ottawa, ON: Department of National Defence.

Shoulder and latissimus pull. This stroke is among the most powerful, because it slices away from the body and does not require a safety stop to protect the user from the blade. The knife is held in the dominant hand and the wood in the non-dominant hand. The arms are held close to the body so when the two objects meet, the chest provides a leverage point. The knife is held at an angle in the hand such that the stroke leads with the handle and the tip of the blade trails. The slice is powered by the shoulders and the back, but the leverage against the chest also helps power it.



Figure 4 Shoulder and Latissimus Pull

Note. Created by Director Cadets 3, 2009, Ottawa, ON: Department of National Defence.

IDENTIFY THE WHITTLING PROCESS

To whittle wood, there are specific steps to follow to successfully create an object. Use the following steps when whittling:



In a survival situation, choose an object that is relatively easy to whittle. A difficult object with many curves and angles requires a meticulous approach, increasing the time required to complete the item.

1. **Determine an object to whittle.** The object selected to whittle are determined based on the needs of the individual in the survival situation. When survival items are limited, the survivor will first determine what to whittle based on priority of needs.



Many whittlers believe that a piece of wood will speak to the whittler—that the object already exists imprisoned deep within the wood, and that it is the whittler's job to let it out.

2. **Select a piece of wood.** The piece of wood should be big enough to whittle down, yet small enough to hold comfortably (depending on the object being whittled).
3. **Ensure the survival knife is sharp.** The knife should be extremely sharp. The sharp blade allows the knife to easily slice and cut away pieces of wood. The actions of the blade are predictable with each stroke. A dull blade requires greater amounts of force and can glance off or move suddenly causing an undesired result or injury. Sharpen if necessary.
4. **Mark the outline, if required.** The item to be whittled may require an outline of the design drawn on the piece of wood to be whittled. The outline guides the cadet to cut and chip the correct areas. This is only required on items that may be more difficult or require a precise design to follow. To mark an outline, use a pencil or pen. If those items are not available scrape the outline on the piece of wood.
5. **Whittle the wood into the object.** Once the design is determined, whittle the item out of the wood.

Teaching Point 4

Explain, demonstrate and have the cadets whittle a whistle using a survival knife.

Time: 55 min

Method: Practical Activity



The whistle is a simple item to whittle out of wood and is a good platform to practice many of the basic cutting strokes, while learning how a simple item can be made from minimal resources. Also, if lost, a whistle could be a key to becoming located by rescuers. This type of whistle would not be chosen in a survival situation, since a drill and wood glue are required.



Provide the cadets with the Whittle a Whistle handout located at Attachment A.

ACTIVITY

OBJECTIVE

The objective of this activity is to have the cadets whittle a whistle.

RESOURCES

- Survival knife (one per cadet),
- One piece of seasoned (dry) wood, approximately 11–12 cm long with the thickness of a broom handle (one per cadet),
- One piece of wood matching the diameter of the drilled hole (one per cadet),

- Wood glue, and
- Whittle a Whistle handout located at Attachment A.

ACTIVITY LAYOUT

Select an area where natural resources for whittling wood may be found.

ACTIVITY INSTRUCTIONS

1. Conduct a briefing to include an explanation of:
 - a. the objectives and importance of the activity;
 - b. the resources that may be required to perform the activity; and
 - c. any safety guidelines that must be followed while performing the activity.
2. Distribute the Whittle a Whistle handout and resources to each cadet.
3. Have cadets whittle a whistle, following the handout procedures step by step.
4. Have the cadets test the whistle.
5. Conduct a debriefing of the activity.

SAFETY

Remind cadets to use the survival knife in a safe manner when whittling wood and avoid whittling toward oneself or in close proximity to others.

CONFIRMATION OF TEACHING POINT 4

The cadets' whittling a whistle will serve as the confirmation of this TP.

END OF LESSON CONFIRMATION

The cadets' whittling a whistle will serve as the confirmation of this lesson.

CONCLUSION

HOMEWORK / READING / PRACTICE

Nil.

METHOD OF EVALUATION

Nil.

CLOSING STATEMENT

Practicing whittling wood with a survival knife in a supervised environment provides an unskilled user with appropriate practices and methods. The survival knife can be a dangerous tool if used incorrectly. Inexperience can cause a serious injury that may threaten survival. Having the skills to manipulate wood keeps one busy in a survival situation, while at the same time creating a useful product.

INSTRUCTOR NOTES / REMARKS

Select an area where natural resources for whittling wood may be found.

The instructor shall remind the cadet to use the survival knife in a safe manner when whittling wood and avoid whittling toward oneself or in close proximity to others.

REFERENCES

C2-228 eHow Hobbies, Games & Toys Editor. (2009). *How to whittle*. Retrieved February 13, 2009, from http://www.eHow.com/how_11286_whittle.html

C2-256 ISBN 978-1-56523-274-7 Lubkemann, C. (2005). *The little book of whittling*. Petersburg, PA: Fox Chapel Publishing, Inc.

C2-257 ISBN 0-918804-53-1 (1986). *Fine wood working on hand tools*. Newtown, CT: The Taunton Press, Inc.

THIS PAGE INTENTIONALLY LEFT BLANK

WHITTLE A WHISTLE

The following instructions describe how to whittle a whistle from two pieces of wood. Step 1 shall be completed by the instructional staff prior to this lesson. However, this step is provided for the purpose of understanding how the whittling of a whistle is completed.

Resources

- a stick or branch that is approximately 11–12 cm long with the thickness of a broom handle, and
- a stick or branch that is smaller in diameter than that of the previous; however has the diameter slightly greater than the diameter of the drill bit used to drill the hole in the first branch.

Instructions

1. Drill a hole in the thick branch. The branch should be approximately 11–12 cm long with the thickness of a broom handle. Stop before reaching the end, as seen in Figures A-1 and A-2.



Figure A-1 Drill a Hole

Note. From *The Little Book of Whittling*, (p. 90), by C. Lubkemann, 2005, East Petersburg, PA: Fox Chapel Publishing, Inc. Copyright 2005 by Fox Chapel Publishing Company, Inc.



Figure A-2 Drill a Hole

Note. From *The Little Book of Whittling*, (p. 90), by C. Lubkemann, 2005, East Petersburg, PA: Fox Chapel Publishing, Inc. Copyright 2005 by Fox Chapel Publishing Company, Inc.

2. Remove the bark halfway around the hole end of the whistle, as seen in Figure A-3.



Figure A-3 Remove Bark

Note. From *The Little Book of Whittling*, (p. 90), by C. Lubkemann, 2005, East Petersburg, PA: Fox Chapel Publishing, Inc. Copyright 2005 by Fox Chapel Publishing Company, Inc.

3. Round and smooth the end, as seen in Figure A-4.



Figure A-4 Rounding

Note. From *The Little Book of Whittling*, (p. 90), by C. Lubkemann, 2005, East Petersburg, PA: Fox Chapel Publishing, Inc. Copyright 2005 by Fox Chapel Publishing Company, Inc.

4. Notch the barked side of the branch with repeated straight and diagonal cuts until about halfway through the drilled hole, as seen in Figure A-5.



Figure A-5 Notching the Stick

Note. From *The Little Book of Whittling*, (p. 91), by C. Lubkemann, 2005, East Petersburg, PA: Fox Chapel Publishing, Inc. Copyright 2005 by Fox Chapel Publishing Company, Inc.

5. Select a smaller branch that has a diameter slightly greater than the diameter of the hole.



Figure A-6 Selecting a Smaller Branch

Note. From *The Little Book of Whittling*, (p. 91), by C. Lubkemann, 2005, East Petersburg, PA: Fox Chapel Publishing, Inc. Copyright 2005 by Fox Chapel Publishing Company, Inc.

6. De-bark the end of the little branch, as seen in Figure A-7.

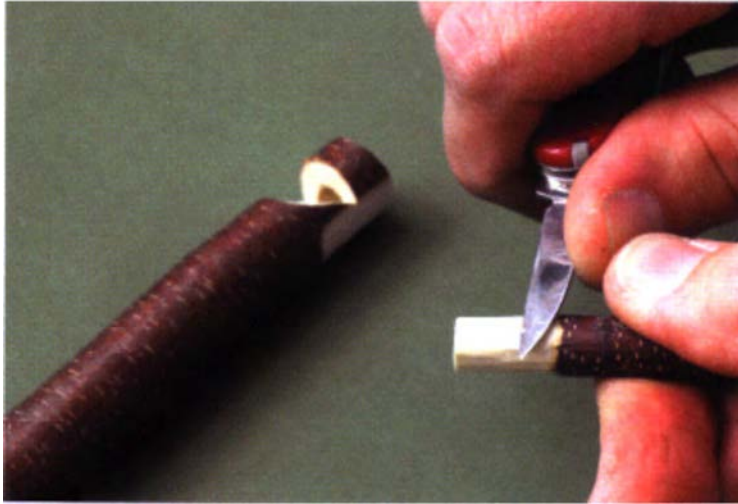

Figure A-7 Whittling a Dowel

Note. From *The Little Book of Whittling*, (p. 91), by C. Lubkemann, 2005, East Petersburg, PA: Fox Chapel Publishing, Inc. Copyright 2005 by Fox Chapel Publishing Company, Inc.

7. Make the smaller branch end into a small dowel that flattens slightly on one side, as seen in Figure A-8.



Figure A-8 Fitting the Dowel

Note. From *The Little Book of Whittling*, (p. 92), by C. Lubkemann, 2005, East Petersburg, PA: Fox Chapel Publishing, Inc. Copyright 2005 by Fox Chapel Publishing Company, Inc.

8. Fit the dowel piece into the hole, flat side up and reaching to the edge of the hole, as seen in Figure A-9.

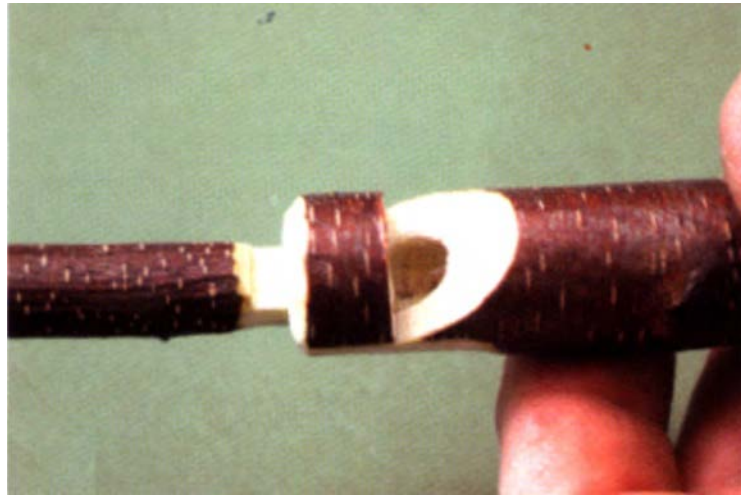

Figure A-9 Fitting the Dowel

Note. From *The Little Book of Whittling*, (p. 92), by C. Lubkemann, 2005, East Petersburg, PA: Fox Chapel Publishing, Inc. Copyright 2005 by Fox Chapel Publishing Company, Inc.

9. Cut the dowel piece flush with the mouthpiece of the whistle, as seen in Figure A-10.



Figure A-10 Cut Dowel

Note. From *The Little Book of Whittling*, (p. 92), by C. Lubkemann, 2005, East Petersburg, PA: Fox Chapel Publishing, Inc. Copyright 2005 by Fox Chapel Publishing Company, Inc.

10. Fill in any cracks with wood glue. Let the glue dry. Once the whistle is dry, test it by blowing the whistle. If the hole is smooth and clean, it should work. Sometimes, the wood may need to dry longer before it will "whistle".



Figure A-11 Glue Cracks

Note. From *The Little Book of Whittling*, (p. 92), by C. Lubkemann, 2005, East Petersburg, PA: Fox Chapel Publishing, Inc. Copyright 2005 by Fox Chapel Publishing Company, Inc.

11. Ensure the whistle looks similar to Figure A-12 and produces a sound when air is blown through the end.



Figure A-12 Finished Whistle

Note. From *The Little Book of Whittling*, (p. 89), by C. Lubkemann, 2005, East Petersburg, PA: Fox Chapel Publishing, Inc. Copyright 2005 by Fox Chapel Publishing Company, Inc.



ROYAL CANADIAN ARMY CADETS

GOLD STAR

INSTRUCTIONAL GUIDE



SECTION 5

EO C424.02 – BOIL WATER USING HEATED ROCKS

Total Time:

60 min

PREPARATION

PRE-LESSON INSTRUCTIONS

Resources needed for the delivery of this lesson are listed in the lesson specification located in A-CR-CCP-704/PG-001, *Gold Star Qualification Standard and Plan*, Chapter 4. Specific uses for said resources are identified throughout the instructional guide within the TP for which they are required.

Review the lesson content and become familiar with the material prior to delivering the lesson.

Prepare and light a fire(s) to use in TP 3 a minimum of one hour prior to instructing this lesson.

PRE-LESSON ASSIGNMENT

Nil.

APPROACH

A group discussion was chosen for TP 1 as it allows the cadets to interact with their peers and share their knowledge, experiences, opinions and feelings on uses of rocks in a survival situation. Sharing in the discussion encourages the cadets to examine their own thoughts and may prompt them to re-think their previously held ideas. Participating in a group discussion improves the cadets' listening skills and team development.

An interactive lecture was chosen for TP 2 as it introduces the cadets to types of rocks and their heating properties.

A practical activity was chosen for TP 3 as it is an interactive way for the cadets to develop skills and knowledge about boiling water using heated rocks in a safe and controlled environment. This activity contributes to the development of survival skills and knowledge in a fun and challenging setting.

INTRODUCTION

REVIEW

Nil.

OBJECTIVES

By the end of this lesson the cadet shall have boiled water using heated rocks.

IMPORTANCE

It is important for cadets to know how natural resources can be used in a survival situation. Rocks can be used in a variety of ways. There are different types of rocks—some of which are more useful than others. Knowing how to boil water using rocks is an extremely beneficial skill, especially when in a survival situation.

Teaching Point 1**Discuss the uses of rocks in a survival situation.**

Time: 5 min

Method: Group Discussion

BACKGROUND KNOWLEDGE

The point of the group discussion is to draw the following information from the group using the tips for answering / facilitating discussion and the suggested questions provided.

USES OF ROCKS IN A SURVIVAL SITUATION

When in a survival situation, there are many uses for rocks.

Insulation

Rocks are able to hold heat very well and can keep a person warm for a long period of time. Placing a heated rock anywhere near the body will help keep it warm during cold days and nights.

One can keep warm while sleeping on the ground by making a rock bed. To make a rock bed, place large, dry, flat stones in a fire pit. Once the stones are hot, remove them and place them in the ground. Cover the area with soil and enjoy. To avoid getting wet, allow time for moisture to evaporate from the ground.

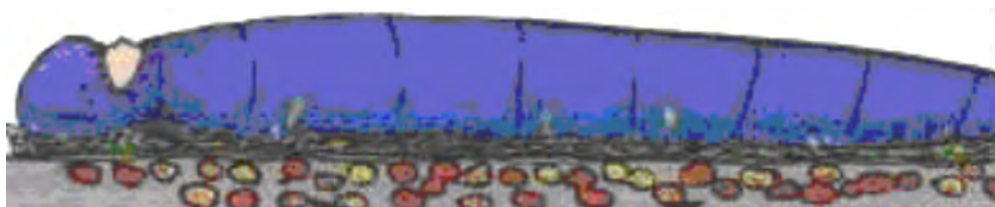

Figure 1 Rock Bed

Note. From *Camping and Wilderness Survival* (p. 417), by P. Tawrell, 2006, Lebanon, NH: Author. Copyright 2006 by Leonard Paul Tawrell.

Cooking

Rocks can be used to cook in a variety of ways. A flat rock can be used in much the same way as a grill and hot rocks can be used (along with grass) to steam food. Small game can be cooked by stuffing it with hot stones. It is also possible to bake food in the ground using rocks. They can also be used to cook or heat food.



Figure 2 Stone Grill

Note. From *Camping and Wilderness Survival* (p. 442), by P. Tawrell, 2006, Lebanon, NH: Author. Copyright 2006 by Leonard Paul Tawrell.

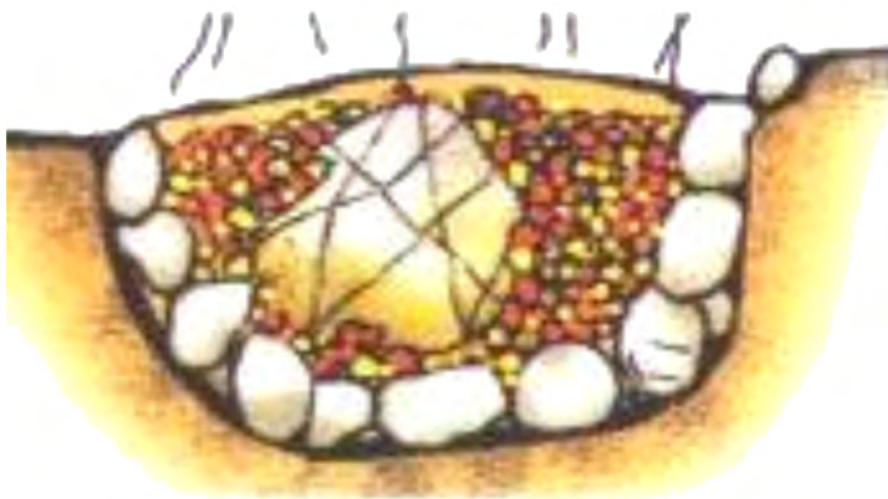

Figure 3 Baking in the Ground

Note. From *Camping and Wilderness Survival* (p. 451), by P. Tawrell, 2006, Lebanon, NH: Author. Copyright 2006 by Leonard Paul Tawrell.



Figure 4 Hot Stone Cooking

Note. From *Camping and Wilderness Survival* (p. 445), by P. Tawrell, 2006, Lebanon, NH: Author. Copyright 2006 by Leonard Paul Tawrell.

Trapping Wildlife for Food

Traps are a way to catch food in the field. They should only be used in a survival situation. There are many different types of traps requiring the use of rocks.



Figure 5 Trap Using Rock—Example 1

Note. From *Tom Brown's Field Guide: Wilderness Survival* (p. 179) by T. Brown, Jr. & B. Morgan, 1983, New York, NY: The Berkley Publishing Group. Copyright 1983 by Tom Brown, Jr.

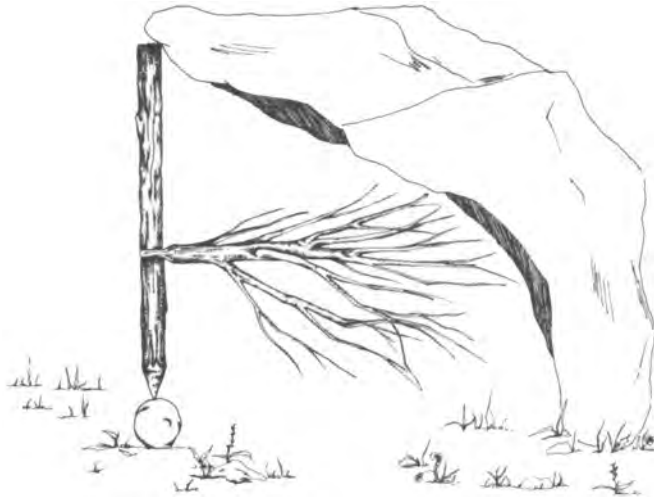

Figure 6 Trap Using Rock—Example 2

Note. From *Tom Brown's Field Guide: Wilderness Survival* (p. 183) by T. Brown, Jr. & B. Morgan, 1983, New York, NY: The Berkley Publishing Group. Copyright 1983 by Tom Brown, Jr.

Building Shelter

A big rock (eg, a cave) will provide a permanent shelter. To increase the height and size of a shelter, as well as keep out rain and wind, build a stone barrier. Rocks can also be used to add weight to a shelter made with a groundsheet or tarp as a way to ensure wind, rain and animals do not enter.

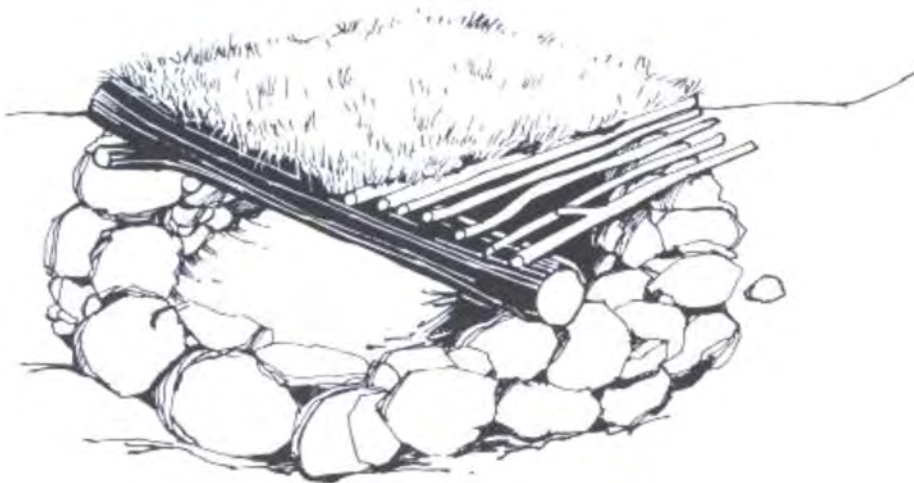

Figure 7 Stone Barrier

Note. From *The SAS Survival Handbook* (p. 246), by J. Wiseman, 1999, Hammersmith, London: HarperCollins Publishers. Copyright 1986 by John Wiseman.



Figure 8 Adding Weight to a Groundsheet

Note. From *The SAS Survival Handbook* (p. 247), by J. Wiseman, 1999, Hammersmith, London: HarperCollins Publishers. Copyright 1986 by John Wiseman.

Tools

Rocks can be used as tools in a variety of ways, such as hammers, knives, carvers, scrapers and sanders. Certain types of rocks can even be used to shape other rocks.

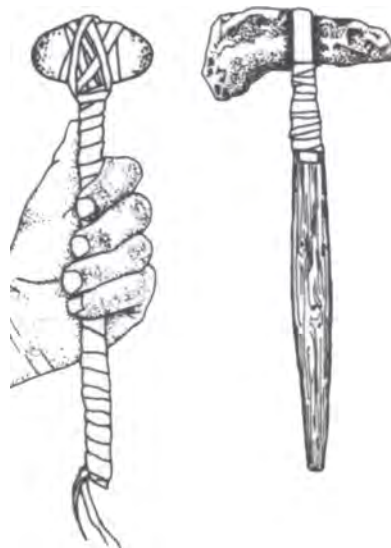

Figure 9 Rock Tools

Note. From *Tom Brown's Field Guide: Living With the Earth* (p. 102) by T. Brown, Jr. & B. Morgan, 1984, New York, NY: The Berkley Publishing Group. Copyright 1984 by Tom Brown, Jr.

GROUP DISCUSSION



TIPS FOR ANSWERING / FACILITATING DISCUSSION:

- Establish ground rules for discussion, eg, everyone should listen respectfully; don't interrupt; only one person speaks at a time; no one's ideas should be made fun of; you can disagree with ideas but not with the person; try to understand others as much as you hope they understand you; etc.
- Sit the group in a circle, making sure all cadets can be seen by everyone else.
- Ask questions that will provoke thought; in other words avoid questions with yes or no answers.
- Manage time by ensuring the cadets stay on topic.
- Listen and respond in a way that indicates you have heard and understood the cadet. This can be done by paraphrasing their ideas.
- Give the cadets time to respond to your questions.
- Ensure every cadet has an opportunity to participate. One option is to go around the group and have each cadet answer the question with a short answer. Cadets must also have the option to pass if they wish.
- Additional questions should be prepared ahead of time.

SUGGESTED QUESTIONS:

- Q1. What can rocks be used for in a survival situation?
- Q2. How can a rock be used as a tool?
- Q3. How can rocks be used to cook?
- Q4. If you were in a survival situation, how could rocks be used to make your shelter more comfortable?



Other questions and answers will develop throughout the group discussion. The group discussion should not be limited to only those suggested.



Reinforce those answers given and comments made during the group discussion, ensuring the teaching point has been covered.

CONFIRMATION OF TEACHING POINT 1

The cadets' participation in the group discussion will serve as the confirmation of this TP.

Teaching Point 2**Identify types of rocks.**

Time: 5 min

Method: Interactive Lecture



Boiling water with heated rocks requires that the rocks be heated to extreme temperatures—which can cause some types of rocks to explode. Some rocks hold heat better than others and are therefore a better choice.

When selecting rocks to heat, **NEVER** pick rocks that are next to a water source (eg, river, swamp, moss, bottom of a hill). Rocks that have moisture inside are likely to explode. Go to higher land to find dry rocks.

TYPES OF ROCKS

Geologists classify rocks into three groups according to the major Earth processes that formed them. The classification system will assist in finding types, but many rocks overlap between categories. The types of rocks are igneous, sedimentary and metamorphic.

Rocks are groups of different minerals pushed together and combined. They are a continuous spectrum of colour, content, form and composition.

Igneous rocks. Formed from magma (molten rock) that has cooled and then solidified. The majority of these rocks formed beneath the Earth's crust. Some examples of igneous rock are granite, pumice, rhyolite and basalt.



Basalt rocks hold heat very well.



Figure 10 Granite

Note. From "Geology.com", 2009, *Igneous Rocks*, Copyright 2005–2009 by Geology.com. Retrieved March 13, 2009, from <http://geology.com/rocks/igneous-rocks.shtml>



Figure 11 Pumice

Note. From "Geology.com", 2009, *Igneous Rocks*, Copyright 2005–2009 by Geology.com. Retrieved March 13, 2009, from <http://geology.com/rocks/igneous-rocks.shtml>



Figure 12 Rhyolite

Note. From "Geology.com", 2009, *Igneous Rocks*, Copyright 2005–2009 by Geology.com. Retrieved March 13, 2009, from <http://geology.com/rocks/igneous-rocks.shtml>



Figure 13 Basalt

Note. From "Geology.com", 2009, *Igneous Rocks*, Copyright 2005–2009 by Geology.com. Retrieved March 13, 2009, from <http://geology.com/rocks/igneous-rocks.shtml>

Sedimentary rocks. Formed in layers near the Earth's surface. They are composed of grains that have been compacted loosely under low pressure. They are normally loose and not very strong. Some examples of sedimentary rocks are coal, iron ore, shale and limestone.

 When selecting rocks to heat, sedimentary rocks are generally a poor choice.



Figure 14 Coal

Note. From "Geology.com", 2009, *Sedimentary Rocks*, Copyright 2005–2009 by Geology.com. Retrieved March 13, 2009, from <http://geology.com/rocks/sedimentary-rocks.shtml>



Figure 15 Iron Ore

Note. From "Geology.com", 2009, *Sedimentary Rocks*, Copyright 2005–2009 by Geology.com. Retrieved March 13, 2009, from <http://geology.com/rocks/sedimentary-rocks.shtml>



Figure 16 Shale

Note. From "Geology.com", 2009, *Sedimentary Rocks*, Copyright 2005–2009 by Geology.com. Retrieved March 13, 2009, from <http://geology.com/rocks/sedimentary-rocks.shtml>



Figure 17 Limestone

Note. From "Geology.com", 2009, *Sedimentary Rocks*, Copyright 2005–2009 by Geology.com. Retrieved March 13, 2009, from <http://geology.com/rocks/sedimentary-rocks.shtml>

Metamorphic rocks. Created by heat / pressure, which changed the rock from one type to another. Since these rocks were created by heat / pressure, they are usually found deep beneath the Earth's surface. Some examples of metamorphic rock are phyllite, slate, hornfels and quartzite.



Slate rocks hold heat very well.



Figure 18 Phyllite

Note. From "Geology.com", 2009, *Metamorphic Rocks*, Copyright 2005–2009 by Geology.com. Retrieved March 13, 2009, from <http://geology.com/rocks/metamorphic-rocks.shtml>



Figure 19 Slate

Note. From "Geology.com", 2009, *Metamorphic Rocks*, Copyright 2005–2009 by Geology.com. Retrieved March 13, 2009, from <http://geology.com/rocks/metamorphic-rocks.shtml>



Figure 20 Hornfels

Note. From "Geology.com", 2009, *Metamorphic Rocks*, Copyright 2005–2009 by Geology.com. Retrieved March 13, 2009, from <http://geology.com/rocks/metamorphic-rocks.shtml>



Figure 21 Quartzite

Note. From "Geology.com", 2009, *Metamorphic Rocks*, Copyright 2005–2009 by Geology.com. Retrieved March 13, 2009, from <http://geology.com/rocks/metamorphic-rocks.shtml>

CONFIRMATION OF TEACHING POINT 2

QUESTIONS:

- Q1. What are the three types of rocks?
- Q2. When selecting rocks to heat, which type of rock is a poor selection?
- Q3. Which rocks hold heat well?

ANTICIPATED ANSWERS:

- A1. The three types of rocks are igneous, sedimentary and metamorphic.
- A2. Sedimentary rocks are a poor selection.
- A3. Basalt and slate.

Teaching Point 3

Have the cadets, in a group of no more than three, boil water using heated rocks.

Time: 40 min

Method: Practical Activity

ACTIVITY

OBJECTIVE

The objective of this activity is to have the cadets, in groups of no more than three, boil water using heated rocks.

RESOURCES

- Water container (one per group),
- Controlled fire (one per group)

- Fire safety equipment, and
- 1 L of water (per group).

ACTIVITY LAYOUT

- Select an area with ample small rocks available for selection.
- Have a fire(s) prepared.

ACTIVITY INSTRUCTIONS

1. Divide the cadets into groups of no more than three.
2. Distribute a water container to each group and place each group at a fire.
3. Have each cadet select a minimum of six rocks about the size of a golf ball.



Due to the time it will take the rocks to heat, encourage the cadets to pick small rocks.

4. Have the cadets place their rocks in the fire.
5. While the rocks are heating:
 - a. have each cadet create a method to remove the rocks from the fire (eg, tongs); and
 - b. have each group place 1 L of water in their container.
6. After the rocks have been in the fire for a minimum of 25 minutes, have each group place two rocks in the water container.
7. Once the rocks have cooled (1–2 minutes), have each group add two more rocks.
8. Have the groups continue adding rocks until the water boils.
9. Have the groups extinguish their fire.



When in a survival situation where a container is not available, boiling can be done in a hollowed log, a rock depression, clay, rawhide, etc.

SAFETY

- Supervisory staff shall have fire safety equipment available in case of emergency.
- Rocks will be extremely hot; use extreme caution.



NEVER pick rocks that are next to a water source (eg, river, swamp, moss, bottom of a hill). Rocks that have moisture inside are likely to explode. Go to higher land when looking for rocks.

CONFIRMATION OF TEACHING POINT 3

The cadets' participation in the activity will serve as the confirmation of this TP.

END OF LESSON CONFIRMATION

The cadets' participation in boiling water using heated rocks will serve as the confirmation of this lesson.

CONCLUSION

HOMEWORK / READING / PRACTICE

Nil.

METHOD OF EVALUATION

Nil.

CLOSING STATEMENT

Rocks are virtually everywhere and have a variety of uses in survival situations. There are different types of rocks—some of which are more useful than others. Understanding the applications of different types of rocks could help an individual when they find themselves in a survival situation. Boiling is not the only option when cooking with rocks. Experiment and have fun!

INSTRUCTOR NOTES / REMARKS

Select an area where the natural resources required may be found.

The instructor shall have prepared a fire(s) for the cadets to use.

REFERENCES

C0-111 ISBN 0-9740820-2-3 Tawrell, P. (2006). *Camping and wilderness survival* (2nd Ed.). Lebanon, NH: Author.

C2-008 ISBN 0-00-2653140-7 Wiseman, J. (1999). *The SAS survival handbook*. Hammersmith, London: HarperCollins Publishers.

C2-068 ISBN 0-425-10572-5 Brown, T., Jr., & Morgan, B. (1983). *Tom Brown's field guide: Wilderness survival*. New York, NY: The Berkley Publishing Group.

C2-227 ISBN 0-425-09147-3 Brown, T., Jr., & Morgan, B. (1984). *Tom Brown's field guide: Living with the earth*. New York, NY: The Berkley Publishing Group.



ROYAL CANADIAN ARMY CADETS

GOLD STAR

INSTRUCTIONAL GUIDE



SECTION 6

EO C424.03 – EMPLOY CATTAILS

Total Time:

60 min

PREPARATION

PRE-LESSON INSTRUCTIONS

Resources needed for the delivery of this lesson are listed in the lesson specification located in A-CR-CCP-704/PG-001, *Gold Star Qualification Standard and Plan*, Chapter 4. Specific uses for said resources are identified throughout the instructional guide within the TP for which they are required.

Review the lesson content and become familiar with the material prior to delivering the lesson.

The cadets will be required to choose one way to employ cattails in TP 3. Some methods will require preparation prior to conducting the lesson (eg, leaves picked and dried for weaving / making cordage, food) and some ways will require resources (eg, fires will require tinder, kindling, fuel, matches, fire safety equipment). Where required, limit or make the initial preparations for the way(s) the cadets will employ cattails. In the case of basket weaving, the cadets could select leaves to use during this lesson and construct the basket on their own time or collect leaves a day before the activity to let them dry.

PRE-LESSON ASSIGNMENT

Nil.

APPROACH

An interactive lecture was chosen for TPs 1 and 2 as it introduces the cadet to the many possible ways that cattails may be employed.

A practical activity was chosen for TP 3 as it is an interactive way for the cadets to employ cattails in a safe and controlled environment.

INTRODUCTION

REVIEW

Nil.

OBJECTIVES

By the end of this lesson the cadet shall have employed cattails.

IMPORTANCE

It is important for cadets to know how to employ cattails as they are abundant throughout North America and have numerous uses. In a survival situation, knowing how to employ cattails could prove to be extremely beneficial. They can be eaten, woven, used for insulation, burnt, and used to treat common ailments.

Teaching Point 1**Identify a cattail and its environment.**

Time: 5 min

Method: Interactive Lecture

A cattail (from the genus *typha*) is a tall, straight plant with sword-like leaves, topped with a cylindrical, sausage-like head. As a cattail matures, it turns from green to brown. In the spring, two green flower heads form at the top of the stalk—the male above and the female below. The sausage-like head is actually the female flower. The male flower grows above the female and disappears once fertilization has been completed.

A cattail can be found in marshes, ditches, wetlands, swamps and stagnant water (fresh or salt) throughout North America. When growing in thick settlements, they can grow up to nine feet tall.



The main parts of a cattail are described in Figure 3.



Finding cattails is a sure sign of nearby water. Military survival specialist and author Tom Squier once found them completely out of their environment, in a dry, sandy pine forest. A short search revealed an open manhole from an abandoned storm sewer system, full of water.



Figure 1 Cattail with Distinct Male and Female Flowers

Note. From "Roger Troy Peterson Institute of Natural History: Electronic Naturalist", *Cattails*, Copyright 2009 by John Wiessinger. Retrieved March 24, 2009, from <http://www.enaturalist.org/units/308/img/Cattailg1.jpg>



Figure 2 Head of a Cattail

Note. From "Ontario Wildflowers", *Ontario Wildflowers*. Retrieved March 25, 2009, from <http://www.wildflowersofontario.ca/cattail.jpg>



In Figure 3, the parts of a cattail are as follows:

- 1 = the female flower,
- 2 = the stem,
- 3 = a leaf, and
- 4 = rootstock.

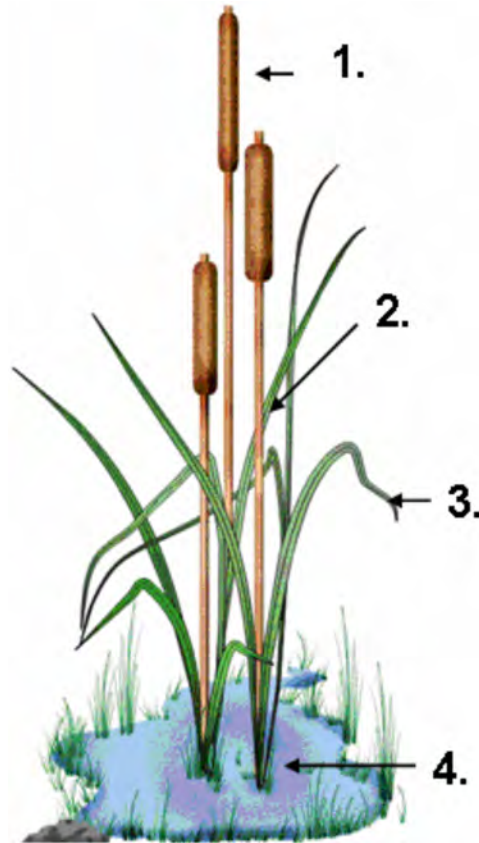

Figure 3 Cattail

Note. From "Pymatuning Cottages" by J. Weigel and K. Danessa. Retrieved March 25, 2009, from <http://www.pymatuningcottages.com/NewFiles/cat-tail.gif>

CONFIRMATION OF TEACHING POINT 1

QUESTIONS:

- Q1. Describe a cattail.
- Q2. Where are cattails found?
- Q3. How tall can a cattail grow?

ANTICIPATED ANSWERS:

- A1. A cattail (from the genus typha) is a tall, straight plant with sword-like leaves, topped with a cylindrical, sausage-like head.
- A2. A cattail can be found in marshes, ditches, wetlands, swamps and stagnant water (fresh or briny) throughout North America.
- A3. When growing in thick settlements, they can grow up to nine feet tall.

Teaching Point 2**Identify ways to employ cattails.**

Time: 15 min

Method: Interactive Lecture

COOKING

Cattails have many delicious and edible parts. It is not an acquired taste, as with many wild edible plants, and will usually please fussy eaters. No matter what time of the year, there is always something edible and nutritious. It is one plant that, when found, can be depended on in a survival situation.

Edible parts of a cattail differ depending on the time of year.

Cattails have so many edible parts that they could be considered a wilderness supermarket.

The rootstock and stem of a cattail are edible raw or boiled. The plant can be pulled up by grasping it at the base. The leaves will disconnect easily from the rootstock. Once the green leaves are pulled back, there will be a white core. This soft core is commonly referred to as "Cossack's asparagus." It is similar to a mild cucumber-like vegetable. For those who like soft vegetables, the rootstock / stem can be boiled for 15 minutes.

Rootstalks are an excellent source of starch. They can be crushed, dissolved in cold water and made into flour after draining and drying. Once thoroughly dried, this flour can be stored and used the same way as store-bought flour.

The pollen from a mature male flower can be gathered from the yellow spikes. It can then be laid in the sun to dry and mixed with water to make dough, which can be baked or cooked. It can also be mixed half-and-half with flour and used as a thickener for foods such as stew or gravy.

Green male flower heads can be husked, boiled and eaten much the same as corn.



Cattail can be used in numerous recipes, which can be found through search engines on the Internet. Some recipes that can be found include:

- cattail pollen pancakes,
- cattail pollen biscuits, and
- cattail wild rice pilaf.



Figure 4 Cattail Pollen

Note. From "Healthlines", *Alaskan Flower Essences—Cattail Pollen*. Retrieved March 25, 2009, from http://www.healthlines.co.uk/FLOWER_ESSENCES/Alaskan_Essences/Alas_Images1/Cattail_Pollen.jpg

WEAVING

Leaves of the cattail can be collected (when green) and woven into mats for flooring or walls. They can also be woven to make baskets.

The stems can be bundled and tied together to form thick sleeping mats.



Figure 5 Cattail Basket

Note. From "North House Folk School", 2009, *Basketry Courses*, Copyright 2009 by North House Folk School. Retrieved March 25, 2009, from <http://www.northhousefolkschool.com/images/Basketry/CattailBasket-035.jpg>



Cattails should only be woven when they are green—usually in the late summer or early fall.

To prepare cattails for weaving:

1. Wear waterproof boots and heavy gloves.
2. Use a long, sharp knife to cut the cattail at the base. Get a large bundle as they will shrink to about a quarter of their original size when dried.
3. Dry the leaves under shade, out of direct sunlight. They could also be laid out on something flat. Air should be able to circulate, so they may need to be flipped occasionally.

In most weaving there are two important elements—the warp and the weft (as illustrated in Figure 6). The warp consists of all the vertical strands and the weft consists of all the horizontal strands. The warp and the weft are interwoven at right angles to each other. To weave a basket with cattails:

1. Lay the leaves on a flat surface.
2. Tightly weave the weft leaves in and out of the warp leaves.
3. Once the bottom of the basket has been formed, bend the sides upward and continue tightly weaving in the leaves.
4. If an extension is needed, overlap a leaf 5–8 cm (2–3 inches) into the leaf that requires an extension and continue weaving.
5. Once the final weft has been woven, there should be about 5 cm (2 inches) of warp leaves sticking up (if there is more, cut the excess off).
6. Bend the warp leaves inward and tuck them tightly between the second or third last weft. The leaves may need to be soaked in order for them to bend.

Note. This type of basket is commonly referred to as a plaited basket.

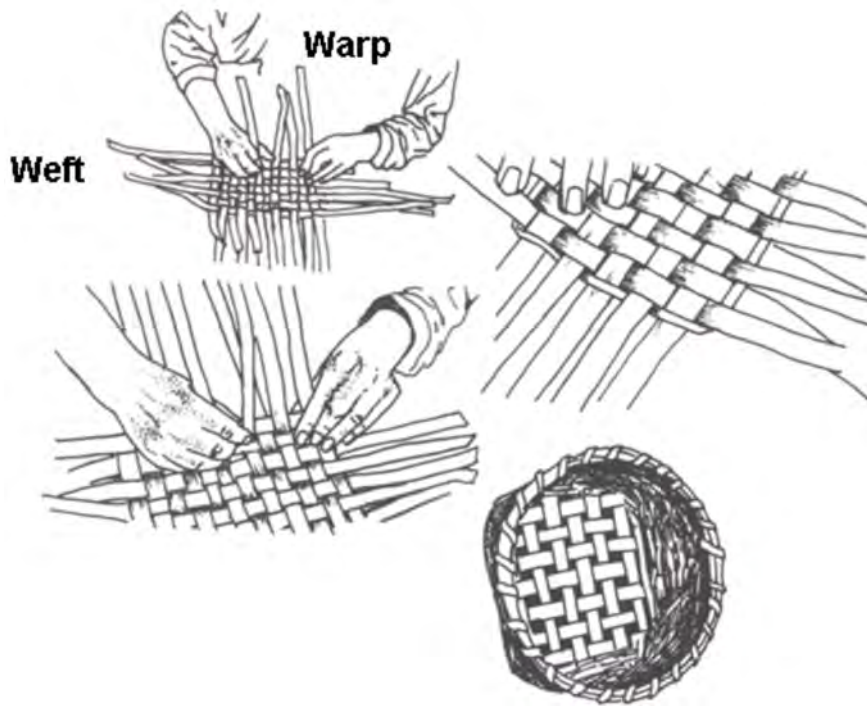

Figure 6 Basket Weaving

Note. From *Tom Brown's Field Guide: Living With the Earth*, p. 90, by T. Brown & B. Morgan, New York, NY: The Berkley Publishing Group. Copyright 1984 by Tom Brown, Jr.

MAKING CORDAGE

Cattail leaves can be used to make cordage. The leaves need to be cut and dried. Once dried, the leaves are split into strips, then dampened and twisted or braided into cordage.



Further information on the process for making cordage can be found in EO M424.04 (Weave Cordage).

INSULATING

Cattails can have fuzzy seeds on the outside or inside, which provide great insulation. Once the insulation has been removed from the cattail head, it can be stuffed into clothing to act as insulation in cold weather. It can also be used to make blankets, sleeping bags or pillows.



Figure 7 Insulation Outside a Cattail—Seed Head

Note. From *Camping and Wilderness Survival: The Ultimate Outdoors Book* (2nd ed.), (p. 331), by P. Tawrell, 2006, Lebanon, NH: Author. Copyright 2006 by Leonard Paul Tawrell.



Figure 8 Insulation Inside a Cattail

Note. From Bioimages, *Plant Features: Fruit and Seed Dispersal*, Copyright 2002 by Steve Baskauf. Retrieved March 25, 2009, from <http://www.cas.vanderbilt.edu/bioimages/t/wtyla--frinfruct17156.jpg>

BURNING

A cattail head dipped in oil or animal fat can be used as a torch.

The fuzzy seeds from the inside / outside of a cattail can be used as tinder to start a fire.



Figure 9 Cattail Torch

*Note. From *Camping and Wilderness Survival: The Ultimate Outdoors Book* (2nd ed.), (p. 437), by P. Tawrell, 2006, Lebanon, NH: Author. Copyright 2006 by Leonard Paul Tawrell.*

TREATING COMMON AILMENTS

Ripe cattail flowers can be mashed and used to soothe cuts and burns.

There is a sticky juice between the leaves that makes a great styptic, antiseptic and anesthetic. It will even numb an aching tooth if rubbed on the gums.

Two to three teaspoons of rootstock flour can be added to one cup of hot water to make an effective remedy to control diarrhea. The usual dosage is two cups a day.

The root contains a pasty starch that has a soothing effect on poison ivy and burns.

Boiled leaves make good external skin wash for rashes and skin irritations.

Pollen can help control bleeding when placed directly on a cut. It can also help relieve pain and can be used as a hair conditioner.

CONFIRMATION OF TEACHING POINT 2

QUESTIONS:

- Q1. What parts of a cattail can be eaten?
- Q2. How can a cattail insulate?
- Q3. What part of a cattail makes a great styptic, antiseptic and anesthetic?

ANTICIPATED ANSWERS:

- A1. The rootstock, stem, pollen, flower head and seeds can all be eaten.
- A2. The fuzzy seeds can be stuffed into clothing to act as insulation in cold weather. It can also be used to make blankets, sleeping bags or pillows.
- A3. The sticky juice between the leaves.

Teaching Point 3

Have the cadets, in groups of no more than three, employ cattails.

Time: 30 min

Method: Practical Activity

ACTIVITY**OBJECTIVE**

The objective of this activity is to have the cadets, in groups of no more than three, employ cattails by:

- cooking;
- weaving;
- making cordage;
- insulating;
- burning; or
- treating common ailments.

RESOURCES

- Cattails,
- Survival knife, and
- Resources will vary, as per selection.

ACTIVITY LAYOUT

- Select an area where cattails can be found.
- If fires will be used, the area must conform to fire safety regulations.

ACTIVITY INSTRUCTIONS

1. Divide the cadets into groups of no more than three.
2. Have the groups select a way to employ cattails.



Where basket weaving is selected, the cadets will have to collect leaves either before or during this lesson. If the leaves are being selected during this lesson, have the cadets bring their basket to the following week's parade night.

3. Have the groups employ cattails.
4. Once completed, have the groups share their results with the other groups.

SAFETY

- Fire safety equipment shall be present if fires are being lit.
- Enforce boundaries for the activity.

CONFIRMATION OF TEACHING POINT 3

The cadets' participation in the activity will serve as the confirmation of this TP.

END OF LESSON CONFIRMATION

The cadets' participation in employing cattails will serve as the confirmation of this lesson.

CONCLUSION

HOMEWORK / READING / PRACTICE

Nil.

METHOD OF EVALUATION

Nil.

CLOSING STATEMENT

Cattails are abundant throughout North America and have numerous important uses. Knowing what can be done with a cattail, as well as how to do it could be extremely beneficial if ever in a survival situation.

INSTRUCTOR NOTES / REMARKS

Select an area where cattails can be found.

Permission may need to be granted before employing cattails.

REFERENCES

C0-111 ISBN 0-9740820-2-3 Tawrell, P. (2006). *Camping and wilderness survival* (2nd ed.). Lebanon, NH: Author.

C2-008 ISBN 0-00-653140-7 Wiseman, J. (1999). *The SAS survival handbook*. Hammersmith, London: HarperCollins Publishers.

C2-068 ISBN 0-425-10572-5 Brown, T., Jr., & Morgan, B. (1983). *Tom Brown's field guide: Wilderness survival*. New York, NY: The Berkley Publishing Group.

C2-226 ISBN 0-425-10063-4 Brown, T., Jr., & Morgan, B. (1985). *Tom Brown's field guide: Wild edible and medicinal plants*. New York, NY: The Berkley Publishing Group.

C2-227 ISBN 0-425-09147-3 Brown, T., Jr., & Morgan, B. (1984). *Tom Brown's field guide: Living with the earth*. New York, NY: The Berkley Publishing Group.



ROYAL CANADIAN ARMY CADETS
GOLD STAR
INSTRUCTIONAL GUIDE



SECTION 7

EO C424.04 – PREPARE REMEDIES FOR COMMON AILMENTS USING MEDICINAL PLANTS

Total Time:

60 min

PREPARATION

PRE-LESSON INSTRUCTIONS

Resources needed for the delivery of this lesson are listed in the lesson specification located in A-CR-CCP-704/PG-001, *Gold Star Qualification Standard and Plan*, Chapter 4. Specific uses for said resources are identified throughout the instructional guide within the TP for which they are required.

Review the lesson content and become familiar with the material prior to delivering the lesson.

This instructional guide is to be used as a guideline. Refer to the reference book, approved by the Regional Cadet Support Unit, specific to the local area for further information on locating, identifying and processing plants, preparing remedies and treating common ailments.

This lesson shall be instructed by a guest speaker with specialist knowledge in preparing remedies.

PRE-LESSON ASSIGNMENT

Nil.

APPROACH

A practical activity was chosen for this lesson as it is an interactive way to allow the cadet to prepare a remedy using medicinal plants in a safe and controlled environment. This activity contributes to the development of survival skills and knowledge in a fun and challenging setting.

INTRODUCTION

REVIEW

Nil.

OBJECTIVES

By the end of this lesson the cadet shall have prepared a remedy using a medicinal plant.

IMPORTANCE

It is important for cadets to know how to identify medicinal plants that are safe and some that may be poisonous. In a survival situation, some plants can be prepared to make a remedy for a common ailment that may aid in the overall health and survival of a person.

Teaching Point 1**Have the cadets, in pairs, prepare a remedy.**

Time: 50 min

Method: Practical Activity

BACKGROUND KNOWLEDGE

This TP is intended to describe the many common ailments that may be treated with medicinal plants.

Ensure the cadets exercise extreme caution when identifying and preparing medicinal plants as some plants are poisonous.

Refer to the approved reference book that is specific to the local area for further information on identifying plants, preparing remedies and treating common ailments.

DESCRIBE MEDICINAL PLANTS**Natural Remedies**

When it comes to medicine, natural medications and remedies can be better for the human body than their synthetic counterparts, which may cause side effects.

Natural plant remedies are available for treating many human illnesses and ailments; however, it is important to know what medicinal plant to look for, as well as where to find it. Although many plants grow in abundance across the country, there are some areas where a particular plant will not flourish.

Historical Practices

For thousands of years, drugs and treatments have been derived from various herbs, plants and natural substances. Many of the drugs still in use today are derived from plant sources. However, extracting the required remedy from some plants is not very easy.

Ancient herbalists did not just randomly mix a concoction and give it to patient—herbology is an exact science. The gathering, preparing and storing of medicinal plants had to be precise and the mixing of the final remedy had to be exact. Herbology science is exactly matched to the patient's lifestyle, body condition, size and need.



Herbalist. A person who specializes in the use of medicinal herbs to treat disease.

Herbology. The use of herbs to treat disease.

DESCRIBE HOW TO TREAT COMMON AILMENTS USING MEDICINAL PLANTS

Infuse. Steep herbs in liquid to extract the content.

Decoction. A process of boiling down so as to extract some essence.

Poultice. A soft medicated heated mass applied to the body and kept in place for relieving soreness and inflammation.

Express. Squeeze out liquid.



Consider the following when preparing medicinal plants for a common illness or ailment:

- To make an infusion, cut and crush the specific part of the plant so that the juices and oils are readily available. Mix with boiling water, stir, let cool and either drink or apply to the affected area.
- To make a decoction, cut, scrape and mash the specific parts of the plant, soak them in water and then boil. Consume as a hot drink.
- To make a poultice, mash the roots or leaves into a flat pad. Apply to the affected area and bind in position.
- To express juice, reduce the plant into a juicy mush. Squeeze the juice into the wound, spread the pulp around the infected area and keep it in place with a leaf and bind.

The following is a list of some of the medicinal plants and treatment(s) for common ailments.

Cold and Flu

Fever. These plants will induce perspiration to break a fever:

- camomile: Infusion of leaves and flowers.
- elder: Infusion of flowers and fruit.
- elm: Decoction of bark.
- feverfew: Infusion of whole plant, except bark.

Headache. These plants can be taken internally:

- willow: Leaves and bark make a decoction containing Salicin, an ingredient in Aspirin.
- elderberry: Infusion of flowers.
- wintergreen: Help with treating headaches.

Aches and pains. These plants can be taken internally:

- balm: Infusion of leaves.
- birch: Infusion of leaves.
- Borage: Infusion of whole plant, except roots.
- burdock: Decoction of roots.
- cattail: Infusion of leaves.
- chickweed: Infusion of whole plant, except roots.
- cowberry: Infusion of leaves and fruits.
- elm: Infusion of bark.
- horsehound: Expressed juice or leaves applied to earache.
- poplar: Infusion of leaf buds.

- solomon's seal: Decoction of roots, to be used externally.
- willow: Decoction of bark.



An example of preparing a cattail for a toothache is to rub the sticky juice between the leaves on the gums.

Colds and sore throats. These plants can be taken internally:

- agrimony: Infusion of whole plant, except roots.
- bilberry: Infusion of leaves and fruits.
- bistort: Infusion of whole plant, except roots.
- borage: Infusion of whole plant, except roots.
- burdock: Decoction of roots.
- camomile: Infusion of flower, to be used as a gargle.
- colt's foot: Infusion of leaves and flowers.
- comfrey: Infusion of whole plant.
- great mullein: Infusion of whole plant, except roots and decoction of roots as a gargle.
- horsehound: Infusion of whole plant, except roots.
- lungwort: Infusion of whole plant, except roots.
- mallow: Infusion of flowers and leaves.
- marsh mallow: Decoction of roots and infusion of leaves and flowers.
- mint: Infusion of whole plant, except roots.
- mountain avens: Infusion of whole plant, to be used as a gargle.
- nettle: Infusion of leaves.
- oak: Decoction of bark, to be used as a gargle.
- plantain: Infusion of leaves and stems.
- poplars: Infusion of leaf buds.
- roses: Decoction of hips.
- sanicle: Infusion of whole plant, except roots.
- self-heal: Infusion of whole plant, except roots, to be used as a gargle.
- St. John's wort: Infusion of flowers and shoots.
- thyme: Infusion of leaves and flowers.
- willow: Decoction of bark.
- yarrow: Infusion of whole plant, except roots, to be used as an inhalant.

Skin Ailments

Bleeding. These plants are to be used externally:

- dove's foot crane's bill: Expressed juice.
- giant puffball: Packed as poultice.
- periwinkle: Expressed juice of leaves.
- plantains: Pounded leaves as poultice.
- self-heal: Expressed juice.
- stork's bill: Expressed juice of leaves.
- woundwort: Expressed juice.

Sores and wounds. These plants can be used externally to bathe the skin or taken internally:

- bulrush: Pounded acorns as poultice.
- camomile: Expressed juice of flowers or as poultice, applied to swelling.
- cattail: Pounded flowers as poultice.
- chickweed: Expressed juice of leaves.
- cleavers: Infusion of whole plant, except roots.
- comfrey: Decoction of roots or as poultice, applied to swelling.
- dead-nettle: Infusion of flowers and roots.
- dock: Crushed leaves applied to bruises.
- dove's foot crane's bill: Infusion of whole plant, except roots, applied to swelling.
- elder: Expressed juice of leaves.
- elm: Infusion of bark.
- figwort: Decoction of whole plant, except roots, to be used externally to draw bruises.
- garlic: Expressed juice applied to swelling.
- horsehound: Infusion of whole plant, except roots.
- horseradish: Decoction of roots.
- mallow: Infusion of leaves and flowers or decoction of leaves and flowers as poultice.
- marsh mallow: Decoction of roots and infusion of flowers and leaves as poultice.
- oak: Decoction of bark.
- plantain: Pounded leaves as poultice.
- sanicle: Infusion of whole plant, except roots.
- scurvey grass: Crushed leaves.

- shepard's purse: Infusion of whole plant, except roots, as poultice.
- spicebrush: Pounded as a poultice.
- solomon's seal: Decoction of roots as poultice.
- sorrel: Crushed leaves applied to bruises.
- St. John's wort: Infusion of flowers and shoots applied to bruises.
- tansy: Crushed leaves applied to bruises.
- thyme: Infusion of leaves and flowers.
- watercress: Expressed juice.
- woundwort: Infusion of whole plant, except roots.
- yarrow: Infusion of whole plant, except roots.



An example of preparing a cattail for cuts and burns is to mash ripe cattail flowers and apply to the skin to soothe cuts and burns.

Itching and stings. These plants are to be used externally:

- amaranth: Infusion of leaves.
- birch: Infusion of twigs and applied to area.
- black alder: Infusion of bark and applied to area.
- bunchberry: Pounded berries as poultice.
- burdock: Decoction of roots crushed raw and salt for some animal bites.
- cattail: Pasty starch of the root has a soothing effect on poison ivy.
- chicory: Pounded leaves and flowers as poultice.
- colt's foot: Infusion of leaves and applied to area.
- goldenrod: Infusion of flowers and applied to area.
- jewelweed: Pounded leaves and stems as poultice.
- reed: Pounded roots as poultice.
- sumac: Pounded seed heads and leaves as poultice.
- thistle: Pounded roots as poultice.

Digestive Ailments

Constipation. These plants can be used externally or internally:

- agrimony: Infusion of whole plant, except roots.
- barberry: Expressed juice of fruit.
- common cleavers: Infusion of whole plant, except roots.

- couch grass: Decoction of root.
- dandelion: Infusion of whole plant.
- elder: Expressed juice of fruit.
- feverfew: Infusion of leaves and flowers.
- rowan: Expressed juice of fruit.
- roses: Decoction of hips.
- walnut: Decoction of bark.

Diarrhea. Most remedies are to be taken two or three times daily, until symptoms subside.

- amaranth: Infusion of leaves.
- bilberry: Decoction of fruit.
- bistort: Infusion of whole plant, except roots.
- bramble: Infusion of leaves or decoction of fruit.
- cattail: Infusion of root.
- cowberry: Decoction of fruit.
- elm: Infusion of bark.
- elderberry: Infusion of flowers
- great burnet: Infusion of leaves and shoots.
- hazel: Infusion of leaves.
- hemlock: Infusion of inner bark.
- marsh mallow: Infusion of leaves and flowers or decoction of roots.
- mint: Infusion of whole plant, except roots.
- mountain avens: Infusion of whole plant, except roots.
- mulberry: Infusion of rootbark.
- oak: Decoction of bark.
- plantain: Infusion of leaves and stems.
- periwinkle: Infusion of leaves.
- silverweed: Infusion of whole plant, except roots.
- sweet fern: Infusion of leaves.

Gas and cramps. These plants can be used externally or internally:

- balm: Infusion of leaves.
- bilberry: Decoction of fruit.

- bracken: Infusion of leaves.
- bramble: Infusion of leaves.
- comfrey: Infusion of roots.
- dandelion: Decoction of whole plant.
- evening primrose: Infusion of leaves.
- horseradish: Infusion of root.
- mint: Infusion of whole plant, except roots, with crushed charcoal.
- mullein: Infusion of flowers.
- solomon's seal: Decoction of root.
- sanicle: Infusion of root.
- yarrow: Infusion of leaves and flowers.



An example of preparing a dandelion for stomach cramps is to steep a small amount of the plant into a cup of hot water. One-half cup in the morning and one-half cup in the evening will aid in digestion and the relieving of stomach cramps.

ACTIVITY

Time: 50 min

OBJECTIVE

The objective of this activity is to have the cadets, in pairs, prepare a remedy by locating and processing a medicinal plant.

RESOURCES

- Survival knife (one per cadet),
- Pots (one per group),
- Bowls (one per group),
- Stone mortar and pestle (one per group),
- Fire safety equipment, and
- Approved reference book for resources required.

ACTIVITY LAYOUT

Nil.

ACTIVITY INSTRUCTIONS

1. Conduct a safety briefing.
2. Divide the cadets into pairs.

3. Describe ways to treat common ailments using medicinal plants.
4. Have the cadets, in pairs, locate one medicinal plant.
5. Inspect the chosen plant(s).
6. Issue each pair resources required to process their plant.
7. Have the cadets process the medicinal plant by:
 - a. making an infusion;
 - b. making a decoction;
 - c. making a poultice; or
 - d. expressing juice.
8. Ensure each pair refers to the approved reference book when preparing their remedy.
9. Circulate and assist the cadets as necessary, offering suggestions and advice.
10. Conduct a debriefing.



The cadets shall not use their remedy.

SAFETY

As some remedies call for boiling water, ensure the local fire regulations are followed when constructing a fire.

CONFIRMATION OF TEACHING POINT 1

The cadets' participation in the activity will serve as the confirmation of this TP.

END OF LESSON CONFIRMATION

The cadets' preparation of a remedy using a medicinal plant will serve as the confirmation of this lesson.

CONCLUSION

HOMEWORK / READING / PRACTICE

Nil.

METHOD OF EVALUATION

Nil.

CLOSING STATEMENT

Being able to prepare medicinal plants within the surrounding environment is essential when looking for a remedy for an illness or ailment in a survival situation. This knowledge will provide a better understanding of the many remedies that can be prepared and how to prepare each plant.

INSTRUCTOR NOTES / REMARKS

This lesson shall be instructed by a guest speaker with specialist knowledge in preparing remedies using medicinal plants.

Select an area where the natural resources required are easily accessible.

When locating and processing medicinal plants, a reference book specific to the area shall be used. This book shall be approved by the Regional Cadet Support Unit.

Fire safety equipment to prepare, light, maintain and extinguish a fire includes the following:

1. 4-lb axe (36-inch handle),
2. 24-inch bow saw,
3. shovel,
4. pail filled with sand or water,
5. tinder, and
6. kindling.

REFERENCES

C2-008 ISBN 0-00-653140-7 Wiseman, J. (1999). *The SAS survival handbook*. Hammersmith, London: HarperCollins Publishers.

C2-226 ISBN 0-425-10063-4 Brown, T., Jr., & Morgan, B. (1985). *Tom Brown's field guide: Wild edible and medicinal plants*. New York, NY: The Berkley Publishing Group.



ROYAL CANADIAN ARMY CADETS
GOLD STAR
INSTRUCTIONAL GUIDE



SECTION 1

EO M425.01 – ESTABLISH EXPEDITION PARAMETERS

| | |
|-------------|--------|
| Total Time: | 30 min |
|-------------|--------|

PREPARATION

PRE-LESSON INSTRUCTIONS

Resources needed for the delivery of this lesson are listed in the lesson specification located in A-CR-CCP-704/PG-001, *Gold Star Qualification Standard and Plan*, Chapter 4. Specific uses for said resources are identified throughout the instructional guide within the TP for which they are required.

Review the lesson content and become familiar with the material prior to delivering the lesson.

Photocopy Section 1 of the Expedition Planning Booklet located at Attachment A for each cadet.

Photocopy the Expedition Parameters Information Sheet located at Attachment B for each cadet.

Photocopy the Silver Star Expedition Information Sheet located at Attachment C for each cadet.

Review the completed Section 1 of the Expedition Planning Booklet located at Attachment D.

PRE-LESSON ASSIGNMENT

Nil.

APPROACH

A group discussion was chosen for TP 1 as it allows the cadets to interact with their peers and share their knowledge and opinions about the reasons for conducting expeditions. Sharing in the discussion encourages the cadets to examine their own thoughts and feelings and may prompt them to re-examine their previously held ideas. Participating in a group discussion improves the cadets' listening skills and team development.

An interactive lecture was chosen for TP 2 to orient the cadets to expedition objectives and generate interest.

An in-class activity was chosen for TP 3 as it is an interactive way to provoke thought and stimulate interest in planning an expedition.

INTRODUCTION

REVIEW

Nil.

OBJECTIVES

By the end of this lesson the cadet shall have established expedition parameters by determining the corresponding goals, objectives and guidelines.

IMPORTANCE

It is important for cadets to establish the parameters for an expedition as this knowledge is a critical first step in the process of planning an expedition. Identifying objectives and guidelines provides the basis to develop all other aspects of the expedition plan. The process for establishing expedition parameters can also be applied to planning other types of activities.

Teaching Point 1**Discuss reasons for conducting expeditions.**

Time: 5 min

Method: Group Discussion

BACKGROUND KNOWLEDGE

The point of the group discussion is to draw the following information from the group using the tips for answering / facilitating discussion and the suggested questions provided.



The *Canadian Oxford Dictionary* defines expedition as an organized voyage or journey across land or water, with a specific goal.

REASONS FOR CONDUCTING EXPEDITIONS

Organizations conduct expeditions for a variety of reasons. In most cases, expeditions are conducted to allow participants to meet the specific outcomes of the organization. Examples include:

- challenging participants;
- developing hard and soft skills;
- providing leadership opportunities;
- increasing physical fitness levels; and
- providing opportunities to earn qualifications.

ARMY CADET EXPEDITION PHILOSOPHY

Army cadet expedition training combines many historical army-related field skills with adventure training to create one of the most challenging and rewarding aspects of army cadet training. Army cadet expedition training evolved from a common vision by stakeholders in 1998 and was refined over the course of a decade.

Expeditions provide an excellent platform for army cadets to achieve the aims and participant outcomes of the cadet program. Expeditions:

- allow army cadets to participate in adventurous activities as part of mandatory training;
- promote recruiting and retention;
- develop leadership skills while enhancing self-reliance, self-confidence, self-esteem, and self-discipline; and
- promote and raise the profile of the Army Cadet Program.

OUTWARD BOUND EXPEDITION PHILOSOPHY



The Outward Bound organization was founded in 1941 by Kurt Hahn in Wales. Hahn claimed that challenge-based outdoor training would benefit the personal development of students. Outward Bound provides students an opportunity to participate in a wilderness expedition that places challenge at the forefront of all activities, thereby allowing for personal growth in self-reliance, physical fitness, craftsmanship, and community service and compassion.

Outward Bound, an outdoor leadership school, uses expeditions as a medium to 'teach' their students about goal setting, teamwork and leadership through practical experiences. These experiences allow for character development in a way that cannot be experienced in a classroom setting or without the inherent struggles and challenges experienced on an expedition. By facing real problems, solving them with newly-learned skills, and making decisions that matter, Outward Bound believes that their students will emerge more aware of their strengths and able to use them in a variety of situations.

GROUP DISCUSSION



TIPS FOR ANSWERING / FACILITATING DISCUSSION:

- Establish ground rules for discussion, eg, everyone should listen respectfully; don't interrupt; only one person speaks at a time; no one's ideas should be made fun of; you can disagree with ideas but not with the person; try to understand others as much as you hope they understand you; etc.
- Sit the group in a circle, making sure all cadets can be seen by everyone else.
- Ask questions that will provoke thought; in other words avoid questions with yes or no answers.
- Manage time by ensuring the cadets stay on topic.
- Listen and respond in a way that indicates you have heard and understood the cadet. This can be done by paraphrasing their ideas.
- Give the cadets time to respond to your questions.
- Ensure every cadet has an opportunity to participate. One option is to go around the group and have each cadet answer the question with a short answer. Cadets must also have the option to pass if they wish.
- Additional questions should be prepared ahead of time.

SUGGESTED QUESTIONS:

- Q1. What is an expedition?
- Q2. How does expedition training differ from training conducted on a field training exercise?
- Q3. Where does expedition training fit within the Army Cadet Program?
- Q4. Using experiences from the Silver Star expedition as a guideline, what are some reasons that expeditions are conducted?



Other questions and answers will develop throughout the group discussion. The group discussion should not be limited to only those suggested.



Reinforce those answers given and comments made during the group discussion, ensuring the teaching point has been covered.

CONFIRMATION OF TEACHING POINT 1

The cadets' participation in the group discussion will serve as the confirmation of this TP.

Teaching Point 2

Discuss expedition goals and objectives.

Time: 10 min

Method: Interactive Lecture



The purpose of this TP is to introduce cadets to the concept of expedition goals and objectives. Encourage cadets to use their own expedition experience(s) to add to the material.

Distribute to each cadet:

- the Expedition Parameters Information Sheet located at Attachment B, and
- a Duo-Tang.

Discuss the Expedition Planning Booklet, by informing cadets that:

- the Expedition Planning Booklet will be used to simulate the planning of an expedition in each of the EOs in PO 425 (Develop an Expedition Plan);
- the Expedition Planning Booklet is divided into sections which mirror the expedition planning process;
- sections of the Expedition Planning Booklet will be completed, during the lesson and as homework, using a Silver Star expedition scenario; and
- each section will be distributed in the corresponding EO and should be placed in a provided Duo-Tang.

The development of sound goals and objectives provides guidance to individuals as they plan an expedition. The foundation of an effective trip plan is well-defined program goals and objectives. Goals and objectives can be divided into two categories:

- trip, and
- program.

Trip goals and objectives can only be developed in conjunction with program goals and objectives. Likewise, program goals and objectives must be developed in conjunction with the overall philosophy of the organization conducting the expedition.



Figure 1 Goals and Objectives Hierarchy

Note. Created by Director Cadets 3, 2009, Ottawa, ON: Department of National Defence.



Remind cadets of the organization philosophy of army cadet expeditions discussed in TP 1 as it relates to the goals and objectives hierarchy.

Goals. Goals represent broad, intended outcomes to be experienced as a result of participating in the expedition. Goals provide direction for leaders and participants as they engage in the expedition experience.

Objectives. Objectives are the targeted outcomes used to assess the accomplishment of each identified goal.

Well-written goals and objectives serve the same purpose as a good map—they provide leaders with a specific path to follow as they create and execute the expedition. Goals and objectives will also assist leaders to make decisions while on the expedition. For example, if a primary goal of developing participants' canoeing skills in Class II moving water was not being met, leaders could choose to cut out a day of hiking to spend an additional day canoeing.

Creating Goals and Objectives

Leaders must put thought and time into the purpose of the expedition when creating goals and objectives. It is important to make goals and objectives:

Specific. Goals and objectives should be specific yet remain flexible from a programming standpoint to allow for differences in group abilities and experiences.

Measurable. Goals and objectives must represent measurable outcomes. For example, ride a mountain bike on familiarization trails, not to exceed Level 3, for 30–40 km.

Achievable. Goals and objectives must be realistic and all required resources must be accessible / available.

Relevant. Goals and objectives must be worthwhile for all individuals involved. It is inadvisable to create a goal and subsequent objectives that affect only certain members of an expedition team.

Timed. Goals and objectives must be able to be completed within the timeframe of the expedition.



Review the purpose for conducting the expedition and the goals and objectives for the Silver Star Expedition as detailed in the Expedition Parameters information sheet. Cadets will be required to transfer that information into Section 1 of the Expedition Planning Booklet.

CONFIRMATION OF TEACHING POINT 2

QUESTIONS:

- Q1. Into what two categories are goals and objectives divided?
- Q2. What are the differences between goals and objectives?
- Q3. When created, goals and objectives must meet what criteria?

ANTICIPATED ANSWERS:

- A1. Goals and objectives are divided into the categories of trip and program.
- A2. Goals represent broad, intended outcomes to be experienced as a result of participating in the expedition. Goals provide direction for leaders and participants as they engage in the expedition experience. Objectives are the targeted outcomes used to assess the accomplishment of each identified goal.
- A3. Goals and objectives must be:
 - specific,
 - measurable,
 - achievable,
 - relevant, and
 - timed.

Teaching Point 3

Have the cadets, in groups of no more than three, identify expedition guidelines and record information in the Expedition Planning Booklet.

Time: 10 min

Method: In-Class Activity



The information included in the Completed Section 1 of the Expedition Planning Booklet, located at Attachment A, was designed as a sample for use in this EO and all subsequent EOs in this PO. In their groups, cadets can develop their own guidelines as long as they meet the expectations of the expedition. If cadets experience difficulties developing guidelines, provide them assistance using information included in the completed Section 1. The guidelines that each group establishes shall be carried forward for all other aspects of the expedition planning process.

The Silver Star Expedition Information Sheet is included to provide cadets with a general idea of the purpose and delivery of the Silver Star expedition. Not all information required to establish the expedition guidelines is included in the information sheet. Cadets will have to work with their group to develop the specific guidelines.

ACTIVITY**OBJECTIVE**

The objective of this activity is to have the cadets, in groups of no more than three, identify expedition guidelines and record the information in the Expedition Planning Booklet.

RESOURCES

- Section 1 of the Expedition Planning Booklet located at Attachment A (one per cadet),
- Expedition Parameters Information Sheet located at Attachment B (one per cadet), and
- Silver Star Expedition Information Sheet located at Attachment C (one per cadet).

ACTIVITY LAYOUT

Nil.

ACTIVITY INSTRUCTIONS

1. Divide the cadets into groups of no more than three.
2. Distribute to each cadet:
 - a. Section 1 of the Expedition Planning Booklet, and
 - b. the Silver Star Expedition Information Sheet.
3. Have each group turn to the page on expedition guidelines in the Expedition Planning Booklet.
4. Introduce the expedition guidelines, to include:
 - a. time of year the expedition is taking place,
 - b. number of days,

- c. number of participants,
 - d. participant experience level,
 - e. budget, if applicable, and
 - f. mode(s) of travel, to include:
 - (1) distance, and
 - (2) terrain.
5. Have the groups read through the Silver Star Expedition Information Sheet.
 6. Have the groups fill in the expedition guidelines in Section 1 of the Expedition Planning Booklet using personal experience and information gathered from the Silver Star Expedition Information Sheet.
 7. Have the groups share their answers.

SAFETY

Nil.

CONFIRMATION OF TEACHING POINT 3

The cadet's participation in the activity will serve as the confirmation of this TP.

END OF LESSON CONFIRMATION**QUESTIONS:**

- Q1. Identify two reasons for conducting expeditions.
- Q2. What is the purpose of creating goals and objectives?
- Q3. What are two guidelines that must be established when planning an expedition?

ANTICIPATED ANSWERS:

- A1. Expeditions are conducted for the following reasons:
 - to challenge participants;
 - to develop hard and soft skills;
 - to provide leadership opportunities;
 - to increase physical fitness levels; and / or
 - to provide opportunities to receive qualifications.
- A2. Goals and objectives serve the same purpose as a good map—they provide leaders with a specific path to follow as they create and execute the expedition. Goals and objectives will also assist leaders in making decisions while out on the expedition.

A3. The following guidelines must be established when planning an expedition:

- time of year expedition is taking place,
- number of days,
- number of participants,
- participant experience level,
- budget, if applicable, and
- mode(s) of travel, to include:
 - distance, and
 - terrain.

CONCLUSION

HOMEWORK / READING / PRACTICE

Complete Section 1 of the Expedition Planning Booklet.

METHOD OF EVALUATION

This lesson is assessed IAW A-CR-CCP-704/PG-001, *Gold Star Qualification Standard and Plan*, Chapter 3, Annex B, 425 PC.

CLOSING STATEMENT

A well-planned expedition is one in which the planners have spent ample time developing a succinct set of goals and objectives that adhere to both the trip and program expectations. Once goals and objectives have been established, the planners will then have what they require to develop the remaining components of the expedition plan. Expedition planning is a multi-purpose skill that can be applied to planning other activities.

INSTRUCTOR NOTES / REMARKS

Nil.

REFERENCES

A2-035 CATO 41-05 Director Cadets 3. (2006). *Army cadet expedition program*. Ottawa, ON: Department of National Defence.

C2-009 ISBN 0-684-85909-2 Harvey, M. (1999). *The national outdoor leadership school's wilderness guide*. New York, NY: Fireside Books.

C2-034 ISBN 0-87322-637-2 Priest, S., & Gass, M. (2005). *Effective leadership in adventure programming* (2nd ed.). Windsor, ON: Human Kinetics Publishing Inc.

C2-153 ISBN 0-7360-5731-5 Martin, B., Cashel, C., Wagstaff, M., & Breunig, M. (2006). *Outdoor leadership: Theory and practice*. Windsor, ON: Human Kinetics Publishing Inc.

C2-208 ISBN 978-1-59485-033-2 Raynolds, J., Lodato, A., Gordon, R., Blair-Smith, C., Welsh, J., & Gerzon, M. (2007). *Leadership the outward bound way*. Seattle, WA: The Mountaineers Books.

EXPEDITION

PLANNING

BOOKLET

Cadet Name: _____

SECTION 1 – EXPEDITION PARAMETERS

IDENTIFY THE PURPOSE FOR CONDUCTING THE EXPEDITION

ESTABLISH EXPEDITION GOALS AND OBJECTIVES:

Goals represent broad, intended outcomes to be experienced as a result of participating in the expedition. Goals provide direction for leaders and participants as they engage in the expedition experience. Objectives are the targeted outcomes used to assess the accomplishment of each identified goal.

When creating goals and objectives it is important to ensure that they follow the SMART (specific, measurable, achievable, relevant and timed) philosophy.

Goal 1

| | |
|---------------------|--|
| | |
| Objective 1: | |
| Objective 2: | |
| Objective 3: | |

Goal 2

| | |
|---------------------|--|
| | |
| Objective 1: | |
| Objective 2: | |
| Objective 3: | |

Goal 3

| | |
|---------------------|--|
| | |
| Objective 1: | |
| Objective 2: | |
| Objective 3: | |

Goal 4

| | |
|---------------------|--|
| | |
| Objective 1: | |
| Objective 2: | |
| Objective 3: | |

IDENTIFY EXPEDITION GUIDELINES

| | |
|--|--|
| Time of Year | |
| Number of Days | |
| Number of Participants | |
| Participant Information: <ul style="list-style-type: none">• age,• gender,• physical fitness level,• health, and• prior experience. | |

| | |
|-------------------------------|--|
| Budget (if applicable) | |
|-------------------------------|--|

| | 1 | 2 | 3 (if applicable) |
|-----------------------|----------|----------|--------------------------|
| Mode of Travel | | | |
| Distance | | | |
| Terrain | | | |

THIS PAGE INTENTIONALLY LEFT BLANK

EXPEDITION PARAMETERS INFORMATION SHEET

IDENTIFY THE PURPOSE FOR CONDUCTING THE EXPEDITION

Silver Star expedition training is designed to provide the Silver Star cadet with the opportunity to develop expedition skills in a structured environment under the supervision and instruction of highly qualified staff.

ESTABLISH EXPEDITION GOALS AND OBJECTIVES

Goal 1

| | |
|--|--|
| To provide challenging activities that promote the development of expedition skills, using an experiential approach. | |
| Objective 1: | Provide cadets with the opportunity to develop their personal expedition skills in at least two of the following modes of travel—mountain biking, canoeing and hiking. |
| Objective 2: | Develop an expedition route that incorporates the selected modes of travel and requires cadets to employ newly-learned skills. |
| Objective 3: | Require cadets to lead at least one leg of the expedition route to assess their ability to successfully navigate from point A to point B. |

Goal 2

| | |
|---|---|
| To provide a variety of opportunities for the cadets to complete daily expedition activities to promote the development of a well-rounded expedition team member. | |
| Objective 1: | Provide cadets with the opportunity to practice campsite set-up and departure routine by changing campsite locations. |
| Objective 2: | Require cadets to perform campsite routine activities such as meal preparation, water purification and food storage. |
| Objective 3: | Require cadets to become familiar with de-kitting procedures associated with expedition training. |

Goal 3

| | |
|--|--|
| To facilitate positive group experiences that enhance character development through social interactions. | |
| Objective 1: | Facilitate formal team briefings at the end of each day of training to discuss team concerns. |
| Objective 2: | Encourage cadets to share their personal experiences with the rest of the team to promote empathy and tolerance for diversity. |
| Objective 3: | Integrate games and team-building activities throughout the expedition to enhance positive social interactions. |

Goal 4

| | |
|---|---|
| To provide a variety of opportunities for personal reflection in order to promote the formation of self-identity. | |
| Objective 1: | Require each cadet to maintain a personal journal throughout the expedition weekend. |
| Objective 2: | Provide a minimum of 15 minutes for cadets to be alone for personal reflection and journal time. |
| Objective 3: | Provide an opportunity for each cadet to have a personal interview with their Team Instructor (TI) at the end of the expedition to discuss their own personal growth and discoveries as a result of the experience. |

SILVER STAR EXPEDITION INFORMATION SHEET

Expedition centre training has been designed to provide the Silver Star cadet with the opportunity to develop expedition skills in a structured environment under the supervision and instruction of highly qualified staff using a weekend format where the cadets will arrive Friday evening and depart Sunday afternoon (2 nights, 3 days).

The expedition centre will provide training through an experiential approach, which will allow the cadet to develop skills such as mountain biking and hiking through direct experience at a personal level. Each cadet will be given the opportunity to examine what they saw, felt and thought during the weekend, and consider how it related to what they already learned as well as how it will relate to future expedition experiences.

Expedition centres will select and train at least two of the following dynamic modes of travel:

- a. canoeing,
- b. mountain biking, or
- c. hiking.

The following are the training expectations for each dynamic mode of travel:

- **Canoeing.** The cadet shall paddle a tandem canoe on flatwater for a distance between 8–10 km.
- **Mountain biking.** The cadet shall ride a mountain bike on familiarization mountain bike trails for a distance between 35–40 km.
- **Hiking.** The cadet shall hike along a route consisting of a combination of Class 1, 2 and 3 terrain for a distance between 8–10 km. At least one third of the route must be Class 3 terrain.

When developing a training schedule, expedition centres may choose to incorporate additional Army Cadet Adventure Training Activities (ACATA) as outlined in A-CR-CCP-951/PT-002, *Royal Canadian Army Cadet Adventure Training Safety Standards*, as long as this does not impede the cadets' ability to meet mandatory training requirements.

All training will be conducted based on a small group model. The cadet will be placed into teams of no more than nine cadets upon arrival Friday evening. An expedition centre Team Instructor (TI) will be assigned to each team and will remain with the team for the duration of the weekend. These team sizes take into account the instructor / cadet training ratios.

All equipment required for the expedition is located at the expedition centre. Models and types of equipment are dependent on the availability of resources within the region and the modes of travel selected. Personal equipment required by cadets is detailed in the cadet joining instructions.

THIS PAGE INTENTIONALLY LEFT BLANK

COMPLETED SECTION 1 OF THE EXPEDITION PLANNING BOOKLET

IDENTIFY THE PURPOSE FOR CONDUCTING THE EXPEDITION

Silver Star expedition training is designed to provide the Silver Star cadet with the opportunity to
develop expedition skills in a structured environment under the supervision and instruction of highly
qualified staff.

ESTABLISH EXPEDITION GOALS AND OBJECTIVES

Goal 1

| | |
|--|--|
| To provide challenging activities that promote the development of expedition skills, using an experiential approach. | |
| Objective 1: | Provide cadets with the opportunity to develop their personal expedition skills in at least two of the following modes of travel—mountain biking, canoeing and hiking. |
| Objective 2: | Develop an expedition route that incorporates the selected modes of travel and requires cadets to employ newly-learned skills. |
| Objective 3: | Require cadets to lead at least one leg of the expedition route to assess their ability to successfully navigate from point A to point B. |

Goal 2

To provide a variety of opportunities for the cadets to complete daily expedition activities to promote the development of a well-rounded expedition team member.

| | |
|---------------------|---|
| Objective 1: | Provide cadets with the opportunity to practice campsite set-up and departure routine by changing campsite locations. |
| Objective 2: | Require cadets to perform campsite routine activities such as meal preparation, water purification and food storage. |
| Objective 3: | Require cadets to become familiar with de-kitting procedures associated with expedition training. |

Goal 3

To facilitate positive group experiences that enhance character development through social interactions.

| | |
|---------------------|--|
| Objective 1: | Facilitate formal team briefings at the end of each day of training to discuss team concerns. |
| Objective 2: | Encourage cadets to share their personal experiences with the rest of the team to promote empathy and tolerance for diversity. |
| Objective 3: | Integrate games and team-building activities throughout the expedition to enhance positive social interactions. |

Goal 4

To provide a variety of opportunities for personal reflection in order to promote the formation of self-identity.

| | |
|---------------------|---|
| Objective 1: | Require each cadet to maintain a personal journal throughout the expedition weekend. |
| Objective 2: | Provide a minimum of 15 minutes for cadets to be alone for personal reflection and journal time. |
| Objective 3: | Provide an opportunity for each cadet to have a personal interview with their Team Instructor (TI) at the end of the expedition to discuss their own personal growth and discoveries as a result of the experience. |

IDENTIFY EXPEDITION GUIDELINES

| | |
|--|---|
| Time of Year | Spring (April–May) / Fall (September–October). |
| Number of Days | 2 nights, 3 days (arrive Friday evening, depart Sunday afternoon). |
| Number of Participants | 36 cadets (12 females, 24 males), 8 staff (5 male, 3 female) = 44 total participants |
| Participant Information: <ul style="list-style-type: none"> • age, • gender, • physical fitness level, • health, and • prior experience. | <ul style="list-style-type: none"> • Cadets are 14–16 years old. • There is a mix of male and female cadets (1/3 female). • The physical fitness level of each participant is unknown (will be identified upon cadet's arrival at expedition centre). • Cadets are either training Silver Star or Silver Star qualified. • Some cadets will have completed Basic Expedition. |
| Budget (if applicable) | Not applicable. |

| | 1 | 2 | 3 (if applicable) |
|-----------------------|-----------------|------------------------|-------------------|
| Mode of Travel | Canoeing | Mountain Biking | |
| Distance | between 8–10 km | between 35–40 km | |
| Terrain | flatwater | familiarization trails | |

THIS PAGE INTENTIONALLY LEFT BLANK



ROYAL CANADIAN ARMY CADETS

GOLD STAR

INSTRUCTIONAL GUIDE



SECTION 2

EO M425.02 – PLAN AN EXPEDITION ROUTE

Total Time:

90 min

PREPARATION

PRE-LESSON INSTRUCTIONS

Resources needed for the delivery of this lesson are listed in the lesson specification located in A-CR-CCP-704/PG-001, *Gold Star Qualification Standard and Plan*, Chapter 4. Specific uses for said resources are identified throughout the instructional guide within the TP for which they are required.

Review the lesson content and become familiar with the material prior to delivering the lesson.

Have the cadets bring their Expedition Duo-Tang.

Gather examples of expedition route planning resources from the local area for TP 1.

Photocopy Section 2 of the Expedition Planning Booklet located at Attachment A for each cadet.

Decide if cadets will develop an expedition route using the area and information provided or an alternate area.

If using the area and information provided:

1. Photocopy the Expedition Route Planning Information handout located at Attachment B for each cadet.
2. Photocopy the resource materials required to complete TPs 4 and 6 located at Attachments C–G for each group.
3. Photocopy on 11 x 17 inch paper the topographical maps located at Attachment I for each group.
4. Review the Completed Section 2 of the Expedition Planning Booklet located at Attachment H.

If an alternate area is selected:

1. Gather, organize and photocopy (if required) the resource materials associated with the area for each group.
2. Create and photocopy the Expedition Planning Information handout for each cadet.
3. Complete the sample Section 2 of the Expedition Planning Booklet located at Attachment A.

PRE-LESSON ASSIGNMENT

Nil.

APPROACH

A group discussion was chosen for TP 1 as it allows the cadets to interact with their peers and share their knowledge and opinions about identifying different types of expedition resource materials. Sharing in the

discussion encourages the cadets to examine their own thoughts and feelings and may prompt them to re-examine their previously held ideas. Participating in a group discussion improves the cadets' listening skills and team development.

An interactive lecture was chosen for TPs 2, 3 and 5 to introduce the cadets to factors that should be considered when planning an expedition route and to provide an introduction to expedition route cards.

An in-class activity was chosen for TPs 4 and 6 as it is an interactive way to provoke thought and stimulate interest in planning an expedition route and preparing a route card.

INTRODUCTION

REVIEW

The review for this lesson is from EO M425.01 (Establish Expedition Parameters).

QUESTIONS:

- Q1. Identify two reasons for conducting expeditions.
- Q2. What is the purpose of creating goals and objectives?
- Q3. What are two guidelines that must be established when planning an expedition?

ANTICIPATED ANSWERS:

- A1. Expeditions are conducted for the following reasons:
 - to challenge participants;
 - to develop hard and soft skills;
 - to provide leadership opportunities;
 - to increase physical fitness levels; and / or
 - to provide opportunities to receive qualifications.
- A2. Goals and objectives serve the same purpose as a good map—they provide leaders with a specific path to follow as they create and execute the expedition. Goals and objectives will also assist leaders in making decisions while on the expedition.
- A3. The following guidelines must be established when planning an expedition:
 - time of year expedition is taking place,
 - number of days,
 - number of participants,
 - participant experience level,
 - budget, if applicable, and
 - mode(s) of travel, to include:
 - distance, and
 - terrain.

OBJECTIVES

By the end of this lesson the cadet shall have planned an expedition route.

IMPORTANCE

It is important for cadets to plan an expedition route as it provides cadets with a tool that can be applied to planning a variety of different activities. Expedition route selection requires cadets to complete research and identify factors in order to choose the best location / route. This process will help to build the cadets' analytical skills in a very practical manner.

Teaching Point 1**Identify expedition route planning resources.**

Time: 10 min

Method: Group Discussion

BACKGROUND KNOWLEDGE



The point of the group discussion is to draw the following information from the group using the tips for answering / facilitating discussion and the suggested questions provided.

EXPEDITION ROUTE PLANNING RESOURCES**Reference Material**

Information on expedition routes can be gathered from a variety of reference materials—print and web-based. Availability of reference material differs from one province / territory to another. Possible sources include:

- topographical maps,
- recreation maps,
- trail maps,
- river maps,
- guidebooks,
- outdoors clubs' newsletters,
- magazines,
- books, and
- websites.

Organizations / Authorities

Within Canada, there are a number of organizations / authorities that can be consulted when planning an expedition route. Depending on the scope of the organization / authority, they can provide information on terrain, trails, campsites, amenities, etc. In some situations, they can also assist with the planning of the route, utilizing their experience with the area to select the best possible route that meets the purpose, goals and objectives of the expedition. As with reference material, organizations and authorities differ greatly from one province / territory to another. Possible organizations / authorities include:

- Parks Canada,
- provincial / territorial parks,
- conservation authorities,
- municipal offices,
- local river / lake authorities,
- outdoors clubs,

- local trail authorities, and
- private property owners.

GROUP DISCUSSION



TIPS FOR ANSWERING / FACILITATING DISCUSSION:

- Establish ground rules for discussion, eg, everyone should listen respectfully; don't interrupt; only one person speaks at a time; no one's ideas should be made fun of; you can disagree with ideas but not with the person; try to understand others as much as you hope they understand you; etc.
- Sit the group in a circle, making sure all cadets can be seen by everyone else.
- Ask questions that will provoke thought; in other words avoid questions with yes or no answers.
- Manage time by ensuring the cadets stay on topic.
- Listen and respond in a way that indicates you have heard and understood the cadet. This can be done by paraphrasing their ideas.
- Give the cadets time to respond to your questions.
- Ensure every cadet has an opportunity to participate. One option is to go around the group and have each cadet answer the question with a short answer. Cadets must also have the option to pass if they wish.
- Additional questions should be prepared ahead of time.

SCENARIO

Consider the following scenario:

The Gold Star cadets have been chosen to plan the Silver Star expedition training weekend. Some of the initial planning for the expedition has been completed—goals and objectives have been established, and expedition guidelines have been identified—but no location has been selected. It is the responsibility of the Gold Star cadets to identify and research possible locations and then plan a route once all factors have been considered.

SUGGESTED QUESTIONS:

- Q1. Where do expeditions usually occur?
- Q2. What stands out in your mind about the location where you completed the Silver Star expedition last year?
- Q3. What types of reference materials do you think were consulted when the planners of the Silver Star expedition were researching a possible location?
- Q4. What types of organizations / authorities could have been approached to find out information on a specific areas / canoe routes / trail systems / campsites?



Other questions and answers will develop throughout the group discussion. The group discussion should not be limited to only those suggested.



Reinforce those answers given and comments made during the group discussion, ensuring the teaching point has been covered.

CONFIRMATION OF TEACHING POINT 1

The cadets' participation in the group discussion will serve as the confirmation of this TP.

Teaching Point 2

Identify factors to consider when selecting an expedition location.

Time: 10 min

Method: Interactive Lecture



Have cadets review the expedition goals, objectives and guidelines they previously recorded in Section 1 of their Expedition Planning Booklets.

Distribute Section 2 of the Expedition Planning Booklet located at Attachment A to each cadet and have them place it in their Duo-Tang.

Distribute the Expedition Route Planning Information handout located at Attachment B to each cadet. If using an alternate area distribute the Expedition Route Planning Information handout created for that area.

Have the cadets turn to the expedition location comparison chart found in the Expedition Route Planning Information handout. Explain that the comparison chart is a tool that can be used to compare expedition locations to select the best possible location.

Review the information detailed in the expedition location comparison chart with the cadets. Have the cadets choose a location and provide at least two reasons why they think it best meets the goals, objectives and guidelines of the expedition.

FACTORS TO CONSIDER WHEN SELECTING AN EXPEDITION LOCATION

Selecting an expedition location is the first step in planning an expedition route. Choosing a location is dependent on a number of factors that can be identified through research of resource materials, such as topographical maps, guidebooks, websites, books and provincial parks. Expedition locations should be selected to meet the established expedition goals, objectives and guidelines.

The most effective way to select an expedition location is to identify a number of possible locations and compare and contrast each location based on the following factors:

- the distance and time needed to travel to and from the location,

- the distance and time needed to obtain emergency services, including:
 - communication, and
 - evacuation routes;
 - the ability to conduct the selected modes of travel, including:
 - distance (per mode of travel and total distance), and
 - terrain (eg, availability of familiarization trails / flatwater);
 - the availability of campsites / rest stops,
 - the ease and cost of obtaining permission to use the area, and
 - the ability to comply with established land management practices, including:
 - fire restrictions,
 - group size limit,
 - restricted camping areas, and
 - closed trails.
-

CONFIRMATION OF TEACHING POINT 2

QUESTIONS:

- Q1. Where could an expedition planner go to find information on possible expedition locations?
- Q2. When selecting an expedition location, what is the primary consideration?
- Q3. When assessing a location's compatibility with the selected modes of travel, the expedition planner should consider what two factors?

ANTICIPATED ANSWERS:

- A1. Expedition planners can consult the following resources to find information on possible expedition locations:
- topographical maps,
 - guidebooks,
 - websites,
 - books, and
 - provincial parks.
- A2. Expedition locations should be selected to meet the established expedition goals, objectives and guidelines.
- A3. The expedition planner should consider if the location meets the mode of travel distance requirements (per mode and total distance) and the terrain requirements (eg, availability of familiarization trails / flatwater).

Teaching Point 3**Identify the elements of an expedition route.**

Time: 10 min

Method: Interactive Lecture



Information in this TP can be presented using a "Think, Pair, and Share" format. This will allow cadets to consider and discuss the elements included in an expedition route based on personal experience. A "Think, Pair and Share" is conducted using the following format:

1. Cadets individually think about the elements included in an expedition route for no more than one minute.
2. Cadets pair up and discuss their ideas for no more than two minutes.
3. Cadets share their ideas with the rest of the class for no more than three minutes.

Record the cadets' answers on flip chart paper. Add elements the cadets missed to the list once all pairs have shared their ideas. Ensure all key points have been presented.

ELEMENTS OF AN EXPEDITION ROUTE

Once the possible expedition location(s) have been identified, the next step in the process is to plan the expedition route. Like location(s), expedition routes are designed to accommodate the goals, objectives and guidelines. It is important that the expedition planner take the time to review the maps and guidebooks associated with the location prior to settling on one specific route. It is advisable to select two to three possible route combinations and assess the validity of each option to meet the requirements of the expedition.

The elements of an expedition route will have some flexibility depending on the location selected. It is the responsibility of the expedition planner to identify the required elements and organize them into an exciting and challenging route. The following are examples of elements that may be incorporated to form the expedition route:

Number of days to complete the expedition. Found in the expedition guidelines and identified in the first step of the expedition planning process.

Pick-up and drop-off points. Ensure that there is enough space at the location for buses and other transportation vehicles. In most cases, pick-up and drop-off points will co-locate with the campsites for the first and last nights.

Campsites. The number of campsites required will be dependant on the number of days of the expedition and whether or not the expedition is linear or circular in design. A linear route will require different campsites every day, whereas the group may arrive back to a site when travelling a circular route. If the area allows for it, it is advisable to choose a primary and secondary campsite for each night. Campsite availability will somewhat dictate the expedition route so campsites should be identified and selected early on in the route planning process.

Modes of travel. Found in the expedition guidelines and identified in the first step of the expedition planning process. The expedition route must be designed so it incorporates the selected modes of travel in a fun, challenging and exciting manner.

Terrain requirements. Found in the expedition guidelines and identified in the first step of the expedition planning process. Identifying the level of terrain for an area / trail / river being used can be done by looking through the resource materials being used to plan the expedition, such as guidebooks or maps.

Distance requirements. Found in the expedition guidelines and identified in the first step of the expedition planning process. The expedition planner must ensure that the expedition route meets the established distance

requirements by measuring the distances for each mode of travel on the topographical map. It is acceptable for there to be minor variances in distance requirements.

Mode(s) of travel change points. Some expedition routes will require multiple modes of travel on the same day. For example, a group may canoe for the morning and then hike to their campsite in the afternoon. If this is the case, it is important that mode of travel change points are identified. These points, like pick-up and drop-off points, require ample room for the delivery and pick-up of equipment.

Lunch locations. Depending on the type of expedition, if participants are carrying their own meals or meals are being provided for them, there may be a requirement for a specified lunch location. Select more than one possible location along the route to allow for variances in speed of participants. When choosing lunch locations consider the availability of water, space, shade, suitable eating area, washroom facilities, etc.

Rest stop / resupply locations. There will always be a requirement to have designated locations along the route where the expedition participants can take a break and resupply items such as water and snacks. There should be at least two per half day of the expedition; however, both do not necessarily have to provide road access. When choosing rest-stop locations consider the availability of water, space, shade, suitable eating area, washroom facilities, etc.

Evacuation routes. When developing an expedition route, it is important to identify evacuation routes to the nearest hospital. This should include the grid reference (GR) of the hospital and then a trace of the route to the hospital. Participants are continuously moving, so planners need to provide route details based on identified starting points and main roads.

CONFIRMATION OF TEACHING POINT 3

QUESTIONS:

- Q1. How many possible route combinations should be identified and assessed when planning an expedition route?
- Q2. Where is information relating to modes of travel, terrain requirements and distance requirements found?
- Q3. When are mode of travel change points required?

ANTICIPATED ANSWERS:

- A1. When planning an expedition route, planners should identify and assess two to three possible route combinations.
- A2. Information relating to modes of travel, terrain requirements and distance requirements is found in the first step of the expedition planning process under expedition guidelines.
- A3. Mode of travel change points are required when the expedition route requires participants to switch from one mode of travel to another on the same day.

Teaching Point 4

Explain and have the cadets, in groups of three, plan an expedition route.

Time: 30 min

Method: In-Class Activity

ACTIVITY

OBJECTIVE

The objective of this activity is for the cadets, in groups of three, to plan an expedition route.

RESOURCES

- Section 2 of the Expedition Planning Booklet located at Attachment A (one per cadet),
- Expedition Route Planning Information handout located at Attachment B or the Expedition Route Planning Information handout created for the alternate area (one per cadet),
- Resource Materials located at Attachments C–G and I or the identified resources for the alternate area (one per group),
- Sample Section 2 of the Expedition Planning Booklet located at Attachment H,
- Expedition Duo-Tang,
- Compass (two per group), and
- Pencil (three per group).

ACTIVITY LAYOUT

Nil.

ACTIVITY INSTRUCTIONS

1. Divide the cadets into groups of three.
2. Ensure each cadet has an Expedition Route Planning Information handout.
3. Distribute resource materials to each group, to include:
 - a. Maps located at Attachment C or maps for the alternate area selected,
 - b. Campground Information located at Attachment D or campground information for the alternate area selected,
 - c. Mountain Bike Trails Information located at Attachment E or mountain bike information for the alternate area selected,
 - d. Canoe Route Information located at Attachment F or canoe route information for the alternate area selected, and
 - e. Hospital Information located at Attachment G or hospital information for the alternate area selected.
 - f. Topographical maps located at Attachment I or topographical maps for the alternate area selected.
4. Brief the cadets on the resource materials provided to ensure they are aware of what is available for them to use to complete the activity.
5. Have groups turn to the page on developing an expedition route in their Expedition Planning Booklet and review the content with the cadets.
6. Have the groups plan two possible expedition routes, using the provided resource materials by:
 - a. completing the Develop an Expedition Route section of their Expedition Planning Booklet, to include:
 - (1) identifying the number of days to complete the expedition;
 - (2) selecting drop-off and pick-up points;

- (3) selecting a primary and possibly a secondary campsite for each night of the expedition;
 - (4) incorporating the selected modes of travel ensuring that:
 - (a) terrain requirements are met, and
 - (b) distance requirements are met;
 - (5) selecting mode of travel change point(s), if required;
 - (6) identifying possible lunch locations for each day;
 - (7) identifying at least two possible rest stop / resupply locations along the route; and
 - (8) identifying evacuation routes to the nearest hospital; and
- b. plotting the routes on the topographical map, to include:
- (1) drop-off and pick-up points,
 - (2) campsites,
 - (3) mode of travel number one route,
 - (4) mode of travel number two route,
 - (5) mode of travel change points,
 - (6) lunch locations,
 - (7) rest stop / resupply locations, and
 - (8) evacuation routes.
7. Have each group compare the two expedition routes and rate them—first choice and second choice—based on compatibility with expedition goals, objectives and guidelines.



Explain that the next step in the process is to conduct a reconnaissance of the most compatible route and then, if required, conduct a reconnaissance of the other route in order to make the final route selection.

SAFETY

Nil.

CONFIRMATION OF TEACHING POINT 4

The cadets' participation in the activity will serve as the confirmation of this TP.

Teaching Point 5**Describe expedition route cards.**

Time: 10 min

Method: Interactive Lecture



This TP is intended to introduce the cadet to creating an expedition route card.

Cadets will remain seated with their groups from the previous TP.

Cadets will be required to complete a schedule (individually) in their Expedition Planning Booklet on their own time. The schedule is included in Section 2 of the Expedition Planning Booklet.



An expedition schedule is usually completed in conjunction with the expedition route card. Schedules vary in both detail and length. They can be a detailed, daily schedule organized by time or a broad overview of activities on a daily basis without time constraints. The schedule guides cadets through the expedition.

PURPOSE OF AN EXPEDITION ROUTE CARD

Expedition route cards are sometimes referred to as time control plans. For the purpose of this TP, they will be identified as expedition route cards.

Every expedition plan must include an expedition route card. Expedition route cards are a critical component of the expedition plan. They provide insight into the terrain, direction of travel, potential dangers, and amount of time required to complete the specific route. The expedition route card is developed to match the goals and ability level of the expedition participants. It provides the participants of the expedition with all the information they need to complete the expedition.



When using expedition route cards, a route is referred to as the entire expedition and each smaller section is referred to as a leg.

On an expedition route card, the entire route is divided into legs with a number of locations identified for rest stops / campsites / mode of travel change points, etc. Once the expedition route card is prepared, the route is planned.



A topographical / trail / river map(s) of the area of travel is required to use in conjunction with the expedition route card.

COMPONENTS OF AN EXPEDITION ROUTE CARD

Have the cadets turn to the Sample Route Card located in the Expedition Route Planning Information handout at Attachment B.

The information included on an expedition route card will vary, depending on the activity(s) being completed during the expedition and the resource material being used to plan the expedition. For example, if the expedition route follows a marked trail system there will be no requirement to include GRs or bearings. In this case, the route description would detail all required information.

It is the responsibility of the expedition planner to identify the key components and develop them in order to create a workable expedition route card.

The following is a list of possible components:

Mode of travel. Modes of travel may include hiking, mountain biking, canoeing, voyageur canoeing or kayaking.

GRs. When GRs are used, there are two for each leg of the route (a "from GR" and a "to GR"). Each should be accompanied by a description (eg, 456 789 Parking Lot).

Bearing. A bearing is determined for each leg of the expedition route once the start and finish GRs have been plotted. In some cases, a bearing is not required.



When bearings are not being used, the route description is filled out in detail for each leg of the route.

Distance. Distance is measured in metres or kilometres, depending on the length of the leg of the route.

Elevation. Elevation for each leg is measured in metres. There are two elevation figures on the expedition route card, one for the start point of the leg and one for the end point of the leg. Rate of travel will differ, depending on elevation.



Including the elevation on the expedition route card provides additional information about the shape and the height of the ground.

Time. The time required to complete a leg of a route can initially be calculated using the law of averages.



Rates of travel will differ, depending on factors such as the group, equipment, terrain, elevation above sea level, etc. On average:

- A person walks 4 km per hour, 1 km per 15 minutes or 100 m per 1.5 minutes.
- Off trail in open terrain, a person can be expected to travel on foot 3 km per hour.
- On rough, difficult terrain, a person can be expected to travel on foot 1–1.5 km per hour.
- When gaining elevation, there should be an extra allowance of 1 hour per every 300 m. When above 3 000 m, the rate of travel will greatly decrease.
- When losing elevation, up to a half an hour can be added for every 1 000 m lost depending on terrain.
- Canoeists paddle 4–5 km per hour in favourable conditions (mild wind, few waves). Speed is also affected by current, paddling experience and time of day.
- The speed of a mountain biker is highly influenced by the types of trail they are riding on and their experience as a mountain biker. The general speed is between 15–25 km per hour.



There should be 10 minutes of rest allowed for every hour of travel.

Route description. The route description is a short but detailed written explanation that has been developed by studying the features of the map between the start and end point of each leg of the expedition route. It is an account of terrain, prominent objects and catching features that should be passed along the leg (eg, follow the path north to a wooden bridge, cross the bridge, and then take the left path west until out of the woods). A description of the end point of the leg should also be recorded (eg, road junction or intersection).



A leg will usually end at a major change in direction or an obvious point.

Group detail. The size, fitness level, knowledge and experience of the group and the equipment that is being carried are factors to consider and may need to be noted on the expedition route card.

| | | | | | |
|--------------------|----------------------|------------------------------|-------------|--------------------------------|---------------------------|
| Date: | 20 Oct 07 / Day 1 | Platoon / Team: | Wild Horses | Location: | Frontenac Provincial Park |
| Start Time: | 0800 hrs | Est. Finish Time: | 1600 hrs | Starting Elevation: | 260 m |

| LEG | MODE OF TRAVEL | FROM GR | TO GR | BEARING | DISTANCE | ELEVATION | TIME | ROUTE DESCRIPTION |
|-----|----------------------|------------|----------|-----------|----------|------------------------|--------|---|
| 1 | Hike | 255 981 | 265 931 | 6350 mils | 4 km | S – 260 m F – 290 m | 60 min | Follow flat terrain, wide paths north, stop at intersection. |
| 2 | Hike | 265 931 | 267 911 | 6100 mils | 4 km | S – 290 m F – 330 m | 90 min | Steep hills, narrow paths, continue north. |
| 3 | Mountain Bike | 267 911 | 315 966 | 1550 mils | 10 km | S – 330 m F – 350 m | 90 min | Some hills, wide gravel road. Go right at fork in the road after last tree. |
| 4 | Mountain Bike | 315 966 | 330 976 | | 2 km | S – 350 m F – 300 m | 30 min | Many hills, narrow and rocky paths with obstacles, stop at bridge |
| 5 | Canoe | 330 976 | 354 970 | | 1.5 km | No change | 30 min | Flatwater. Stay river left of small island. |
| 6 | Canoe | 354 970 | 358 982 | | 1 km | No change | 60 min | Flatwater. Land at third campsite on river left. |
| 7 | Hike | 358 982 | 384 001 | | 3.5 km | S – 300 m F – 250 m | 90 min | Some hills, narrow path, finish at main parking lot. |

| | |
|-----------------------|--|
| Group Details: | Team has eight members—four females and four males—who all possess a high level of physical fitness. Three members completed Basic Expedition and two members completed Expedition Instructor. |
|-----------------------|--|

Figure 1 Sample Route Card

Note. Created by Director Cadets 3, 2008, Ottawa, ON: Department of National Defence.

CONFIRMATION OF TEACHING POINT 5

QUESTIONS:

- Q1. What is the purpose of an expedition route card?
- Q2. On an expedition route card, the entire route is divided into what smaller sections?
- Q3. How should the time required to complete the route be calculated?

ANTICIPATED ANSWERS:

- A1. An expedition route card is a critical component of the expedition plan. It provides insight into the terrain, direction of travel, potential dangers, and amount of time required to complete the specific route.
- A2. On an expedition route card, the entire route is divided into legs with a number of locations identified for rest stops / campsites / mode of travel change points, etc.
- A3. The time required can be calculated by the average speed of a person (the average person walks 4 km per hour). This gives the time for 1 km as 15 minutes for each 100 m as approximately 1.5 minutes.

Teaching Point 6

Explain and have the cadets, in groups of three, prepare an expedition route card.

Time: 10 min

Method: In-Class Activity

ACTIVITY
OBJECTIVE

The objective of this activity is to have the cadet, in groups of three, prepare an expedition route card.

RESOURCES

- Section 2 of the Expedition Planning Booklet located at Attachment A (one per cadet),
- Expedition Route Planning Information handout located at Attachment B or the Expedition Route Planning Information handout created for the alternate area (one per cadet),
- Resource Materials located at Attachments C–G and I or the identified resources for the alternate area (one per group),
- Sample Section 2 of the Expedition Planning Booklet located at Attachment H,
- Expedition Duo-Tang,
- Compass (two per group), and
- Pencil (three per group).

ACTIVITY LAYOUT

Nil.

ACTIVITY INSTRUCTIONS

1. Ensure each group has:
 - a. resource materials, and
 - b. the Expedition Route Planning Information handout.
2. Distribute to each group:
 - a. pencils, and
 - b. compasses.

3. Have the groups turn to the Prepare an Expedition Route Card section of the Expedition Planning Booklet.
4. Have the groups prepare an expedition route card, for their selected route, in their Expedition Planning Booklet by:
 - a. recording:
 - (1) the date of the expedition,
 - (2) expedition location,
 - (3) start time,
 - (4) estimated finish time,
 - (5) starting elevation, and
 - (6) group details; and
 - b. filling in the following components:
 - (1) mode of travel,
 - (2) from GR and to GR (if required),
 - (3) bearing (if required),
 - (4) distance,
 - (5) elevation,
 - (6) time, and
 - (7) route description.

SAFETY

Nil.

CONFIRMATION OF TEACHING POINT 6

The cadets' participation in preparing a route card will serve as the confirmation of this TP.

END OF LESSON CONFIRMATION

The cadets' participation in planning an expedition route and preparing an expedition route card will serve as the confirmation of this lesson.

CONCLUSION

HOMEWORK / READING / PRACTICE

Cadets must ensure that all of Section 2 of the Expedition Planning Booklet are completed prior to EO M425.03 (Develop an Expedition Equipment List).

METHOD OF EVALUATION

This lesson is assessed IAW A-CR-CCP-704/PG-001, *Gold Star Qualification Standard and Plan*, Chapter 3, Annex B, 425 PC.

CLOSING STATEMENT

Planning an expedition route that satisfies the expedition goals, objectives and guidelines is a critical component of expedition planning. The key to a successful expedition is a well planned expedition route. Once the route has been established, the preparation of the expedition route card will ensure that all participating members are aware of all facets of the trip. A prepared, well-organized and detailed expedition route card will effectively guide participants along the route.

INSTRUCTOR NOTES / REMARKS

Nil.

REFERENCES

A2-064 A-CR-CCP-050-804/PF-001 Director Cadets 6. (2008). *Instructional guide: DP 1 Cadet Instructor Cadre land environmental training course*. Ottawa, ON: Department of National Defence.

C0-007 ISBN 0-02-029265-1 Kjellstrom, B. (1994). *Be expert with map & compass: The complete orienteering handbook*. New York, NY: Hungry Minds, Inc.

C2-009 ISBN 0-684-85909-2 Harvey, M. (1999). *The national outdoor leadership school's wilderness guide*. New York, NY: Fireside Books.

C2-016 ISBN 0-517-88783-5 Curtis, R. (1998). *The backpacker's field manual: A comprehensive guide to mastering backcountry skills*. New York, NY: Three Rivers Press.

C2-017 ISBN 0-7627-0476-4 Roberts, H. (1999). *Basic essentials, backpacking*. Guilford, CT: The Globe Pequot Press.

C2-034 ISBN 0-87322-637-2 Priest, S., & Gass, M. (2005). *Effective leadership in adventure programming* (2nd ed.). Windsor, ON: Human Kinetics Publishing Inc.

C2-051 ISBN 978-0-7153-2254-0 Bagshaw, C. (2006). *The ultimate hiking skills manual*. Cincinnati, OH: David and Charles.

C2-110 ISBN 978-0-89886-953-6 Burns, B., & Burns, M. (2004). *Wilderness navigation* (2nd ed.). Seattle, WA: The Mountaineers Books.

C2-153 ISBN 0-7360-5731-5 Martin, B., Cashel, C., Wagstaff, M., & Breunig, M. (2006). *Outdoor leadership: Theory and practice*. Windsor, ON: Human Kinetics Publishing Inc.

C2-208 ISBN 978-1-59485-033-2 Reynolds, J., Lodato, A., Gordon, R., Blair-Smith, C., Welsh, J., & Gerzon, M. (2007). *Leadership the outward bound way*. Seattle, WA: The Mountaineers Books.

THIS PAGE INTENTIONALLY LEFT BLANK

SECTION 2 – PLAN AN EXPEDITON ROUTE

IDENTIFY EXPEDITION ROUTE PLANNING RESOURCES

When planning an expedition route, there are a variety of reference materials and organizations / authorities that can assist the expedition planner.

Listing the planning resources that have been consulted or contacted is beneficial not only in planning the current expedition but for future expedition planning as well.

| Reference Materials | Organizations / Authorities |
|---------------------|-----------------------------|
| | |
| | |
| | |
| | |
| | |

IDENTIFY FACTORS TO CONSIDER WHEN SELECTING AN EXPEDITION ROUTE

Choosing an expedition location is dependent on a number of factors that can be identified through research of resource materials. Expedition locations should be selected to meet the established expedition goals, objectives and guidelines.

The most effective way to select an expedition location is to identify a number of possible locations and compare and contrast the suitability of each location.

Selecting an Expedition Location Comparison Chart

| | Location #1 | Location #2 | Location #3 |
|---|--------------------|--------------------|--------------------|
| What is the distance to and from the location? | | | |
| How long does it take to travel to and from the location? | | | |
| How long will it take to get to or receive emergency services? | | | |
| Is there adequate space at start and end points for drop-off of personnel and equipment? | | | |
| Can the distance requirements for mode of travel #1 be met? Can the terrain requirements for mode of travel #1 be met? | | | |
| Can the distance requirements for mode of travel #2 be met? Can the terrain requirements for mode of travel #2 be met? | | | |

| | Location #1 | Location #2 | Location #3 |
|---|-------------|-------------|-------------|
| Are there a number of campsites / rest stops available in the area? | | | |
| What are the associated costs of using the area? | | | |
| What are the procedures to gain access to use the area? | | | |
| Are there any limitations on group sizes? | | | |
| Are there any restricted camping areas? | | | |

An expedition location must now be chosen. In some cases, it is difficult to select a location from the comparison alone. The expedition planner may have to conduct a physical reconnaissance of the areas to assist in the selection process.

Chosen location:

Reasons for choosing location:

DEVELOP AN EXPEDITION ROUTE

Like the location(s), expedition routes should be designed to accommodate the goals, objectives and guidelines of the expedition. A detailed review of the maps and guidebooks associated with the location must now take place before a specific route is selected. Two to three possible route combinations should be developed and assessed for their ability to meet the requirements of the expedition.

The expedition route is penciled in on the topographical map of the area. The expedition planner uses conventional signs to identify the key elements of the expedition route on the topographical map. If possible, GRs and location identifiers should be recorded.

Length of the expedition: _____

| | Route #1 | Route #2 |
|--|-----------------|-----------------|
| Drop-off point and campsite. | | |
| Mode(s) of travel for day #1. | | |
| Mode of travel change point(s) for day #1, if required. | | |
| Possible lunch locations for day #1. | | |

| | Route #1 | Route #2 |
|--|-----------------|-----------------|
| Possible rest-stop / resupply locations for day #1. | | |
| Evacuation route(s) for day #1. | | |
| Possible campsite(s) for night. | | |
| Mode(s) of travel for day #2. | | |
| Mode of travel change point(s) for day #2, if required. | | |
| Possible lunch locations for day #2. | | |
| Possible rest-stop / resupply locations for day #2. | | |

| | Route #1 | Route #2 |
|--|-----------------|-----------------|
| Evacuation route(s) for day #2. | | |
| Pick-up point. | | |
| Rate routes based on their ability to comply with the goals, objectives and guidelines of the expedition. | | |

PREPARING AN EXPEDITION ROUTE CARD

Expedition route cards are a critical component of the expedition plan that provide insight into the terrain, direction of travel, potential dangers, and amount of time required to complete the specific route. A well developed expedition route card provides the participants of the expedition with all the information they need to complete the expedition.

The information included on an expedition route card varies depending on the activity(s) being completed during the expedition and the resource material being used to plan the expedition. For example, if the expedition route follows a marked trail system there is no requirement to include GRs or bearings. In this case, the route description details all required information.

Route Card–Day _____

| | | | | | |
|--------------------|--|-------------------------------|--|----------------------------|--|
| Date: | | Team: | | Location: | |
| Start Time: | | Estimated Finish Time: | | Starting Elevation: | |

| Leg | Mode of Travel | From GR | To GR | Bearing | Distance | Elevation | Time | Route Description |
|------------|-----------------------|----------------|--------------|----------------|-----------------|------------------|-------------|--------------------------|
| 1 | | | | | | | | |
| 2 | | | | | | | | |
| 3 | | | | | | | | |
| 4 | | | | | | | | |
| 5 | | | | | | | | |
| 6 | | | | | | | | |
| 7 | | | | | | | | |

| | |
|-----------------------|--|
| Group Details: | |
|-----------------------|--|

Route Card–Day _____

| | | | | | |
|--------------------|--|-------------------------------|--|----------------------------|--|
| Date: | | Team: | | Location: | |
| Start Time: | | Estimated Finish Time: | | Starting Elevation: | |

| Leg | Mode of Travel | From GR | To GR | Bearing | Distance | Elevation | Time | Route Description |
|------------|-----------------------|----------------|--------------|----------------|-----------------|------------------|-------------|--------------------------|
| 1 | | | | | | | | |
| 2 | | | | | | | | |
| 3 | | | | | | | | |
| 4 | | | | | | | | |
| 5 | | | | | | | | |
| 6 | | | | | | | | |
| 7 | | | | | | | | |

| | |
|-----------------------|--|
| Group Details: | |
|-----------------------|--|

CREATE AN EXPEDITION SCHEDULE

An expedition schedule is usually completed in conjunction with the expedition route card. Schedules vary in both detail and length. They can be a detailed, daily schedule organized by time or a broad overview of daily activities without time constraints. The schedule guides participants through the expedition.

| Day _____ | | |
|-----------|------------------|---------|
| Timings | Tasks / Activity | Remarks |
| | | |
| | | |
| | | |
| | | |
| | | |
| | | |

| Day _____ | | |
|-----------|------------------|---------|
| Timings | Tasks / Activity | Remarks |
| | | |
| | | |
| | | |

| Timings | Tasks / Activity | Remarks |
|---------|------------------|---------|
| | | |
| | | |
| | | |
| | | |
| | | |
| | | |
| | | |
| | | |
| | | |

| Day _____ | | |
|-----------|------------------|---------|
| Timings | Tasks / Activity | Remarks |
| | | |
| | | |
| | | |
| | | |

| Timings | Tasks / Activity | Remarks |
|---------|------------------|---------|
| | | |
| | | |
| | | |
| | | |
| | | |
| | | |
| | | |
| | | |

THIS PAGE INTENTIONALLY LEFT BLANK

EXPEDITION ROUTE PLANNING INFORMATION HANDOUT

Identify Expedition Route Planning Resources

| Reference Materials | Organizations / Authorities |
|--|---------------------------------------|
| Ontario Recreation Map | Ontario Parks |
| Topographical maps–Markdale, Collingwood, Goderich, Lucknow, Wingham, Chesley, Walkerton and Wiarton | Saugeen Valley Conservation Authority |
| Canadian Canoe Routes–www.myccr.com | Grey Sauble Conservation Authority |
| Ontario Trails Council–www.ontariotrails.on.ca | Bruce Trail Association |
| <i>Backroad Map Book–Southwestern Ontario</i> | Maitland Conservation Authority |
| <i>A Paddlers Guide to Wilderness Weekend Adventures</i> by Kevin Callan | |
| <i>A Paddlers Guide to The Rivers of Ontario and Quebec</i> by Kevin Callan | |
| MapQuest | |

Select an Expedition Location Comparison Chart

| | Location #1 | Location #2 | Location #3 |
|---|---|---|---|
| | Walkerton | Wingham | Thornbury |
| What is the distance to and from the location? | Niagara Falls—231 km Windsor—346.45 km | Niagara Falls—228.07 km Windsor—313 km | Niagara Falls—256.84 km Windsor—444.02 km |
| How long does it take to travel to and from the location? | Niagara Falls—3.15 hours Windsor—4.46 hours | Niagara Falls—3 hours Windsor—4.10 hours | Niagara Falls—3.17 hours Windsor—5.35 hours |
| How long will it take to get to or receive emergency services? | Hospitals located in Chesley, Walkerton and Hanover. Furthest distance is 15 km. Call 911. | Hospitals located in Wingham and Goderich. Furthest distance is 20 km. Call 911. | Hospitals located in Markdale, Collingwood and Meaford. Furthest distance is 25 km. Call 911. |
| Is there adequate space at start and end points for drop-off of personnel and equipment? | Yes. Various points in area for start and end points. | Yes. Various points in area for start and end points. | Yes. Various points in area for start and end points. |
| Can the distance requirements for mode of travel #1 be met? | Saugeen River—Walkerton to Paisley—39 km—earlier take-out points available. | Maitland River—Wingham to Auburn—25 km— earlier take-out points available. | Beaver River— Kimberly to Heathcote—25 km— earlier take-out points available. |
| Can the terrain requirements for mode of travel #1 be met? | Mostly flatwater, some swifts depending on time of year, lift-overs and sweepers. | Flatwater, some swifts depending on time of year, lift-overs. | Flatwater. |
| Can the distance requirements for mode of travel #2 be met? | Brant Tract Trail System— over 25 km of trails. Roads leading to Brant Tract increase distance. | Carrick Tract Trail System— over 13 km of trails. Roads leading to Carrick Tract increase distance. | Kolapore Uplands Wilderness Ski Trails— over 30 km of trails. Roads leading to Kolapore Ski Trails increase distance. |

| | Location #1 | Location #2 | Location #3 |
|--|---|---|---|
| Can the terrain requirements for mode of travel #2 be met? | Novice double- and single- track trails, intermediate single-track trails, dirt roads and paved roads. | Novice double- and single-track trails, intermediate single-track trails, dirt roads and paved roads. | Novice double- and single-track trails, intermediate single-track trails, dirt roads and paved roads. |
| Are there a number of campsites / rest stops available in the area? | Two Conservation Area campgrounds and three privately owned campgrounds. | Four privately owned campsites and one Conservation Area campground | Two privately owned campgrounds. |
| What are the associated costs of using the area? | Costs for campsites are between \$15 and \$30 per night. Group rates are available. | Costs for campsites are between \$12 and \$30 per night. Group rates are available. | Costs for campsites are between \$10 and \$25 per night. Group rates are available. |
| What are the procedures to gain access to use the area? | Contact Grey Bruce Conservation Authority. | Contact Maitland Valley Conservation Authority and Grey Bruce Conservation Authority. | Contact Grey Sable Conservation Authority. |
| Are there any limitations on group sizes? | No limits—just dependent on availability of campsites. | No limits—just dependent on availability of campsites. | No limits—just dependent on availability of campsites. |
| Are there any restricted camping areas? | Can only camp in designated campgrounds. Rest stops can occur at campgrounds, conservation areas and crown land. No stopping on private land. | Can only camp in designated campgrounds. Rest stops can occur at campgrounds, conservation areas and crown land. No stopping on private land. | Can only camp in designated campgrounds. Rest stops can occur at campgrounds, conservation areas and crown land. No stopping on private land. |

Chosen location:

Reasons for choosing location:

| | | | | | |
|--------------------|----------------------|------------------------------|-------------|--------------------------------|---------------------------|
| Date: | 20 Oct 07 / Day 1 | Platoon / Team: | Wild Horses | Location: | Frontenac Provincial Park |
| Start Time: | 0800 hrs | Est. Finish Time: | 1600 hrs | Starting Elevation: | 260 m |

| LEG | MODE OF TRAVEL | FROM GR | TO GR | BEARING | DISTANCE | ELEVATION | TIME | ROUTE DESCRIPTION |
|-----|----------------------|------------|----------|-----------|----------|------------------------|--------|---|
| 1 | Hike | 255 981 | 265 931 | 6350 mils | 4 km | S – 260 m F – 290 m | 60 min | Follow flat terrain, wide paths north, stop at intersection. |
| 2 | Hike | 265 931 | 267 911 | 6100 mils | 4 km | S – 290 m F – 330 m | 90 min | Steep hills, narrow paths, continue north. |
| 3 | Mountain Bike | 267 911 | 315 966 | 1550 mils | 10 km | S – 330 m F – 350 m | 90 min | Some hills, wide gravel road. Go right at fork in the road after last tree. |
| 4 | Mountain Bike | 315 966 | 330 976 | | 2 km | S – 350 m F – 300 m | 30 min | Many hills, narrow and rocky paths with obstacles, stop at bridge |
| 5 | Canoe | 330 976 | 354 970 | | 1.5 km | No change | 30 min | Flatwater. Stay river left of small island. |
| 6 | Canoe | 354 970 | 358 982 | | 1 km | No change | 60 min | Flatwater. Land at third campsite on river left. |
| 7 | Hike | 358 982 | 384 001 | | 3.5 km | S – 300 m F – 250 m | 90 min | Some hills, narrow path, finish at main parking lot. |

| | |
|-----------------------|--|
| Group Details: | Team has eight members—four females and four males—who all possess a high level of physical fitness. Three members completed Basic Expedition and two members completed Expedition Instructor. |
|-----------------------|--|

Figure B-1 Sample Route Card

Note. Created by Director Cadets 3, 2008, Ottawa, ON: Department of National Defence.

MAPS

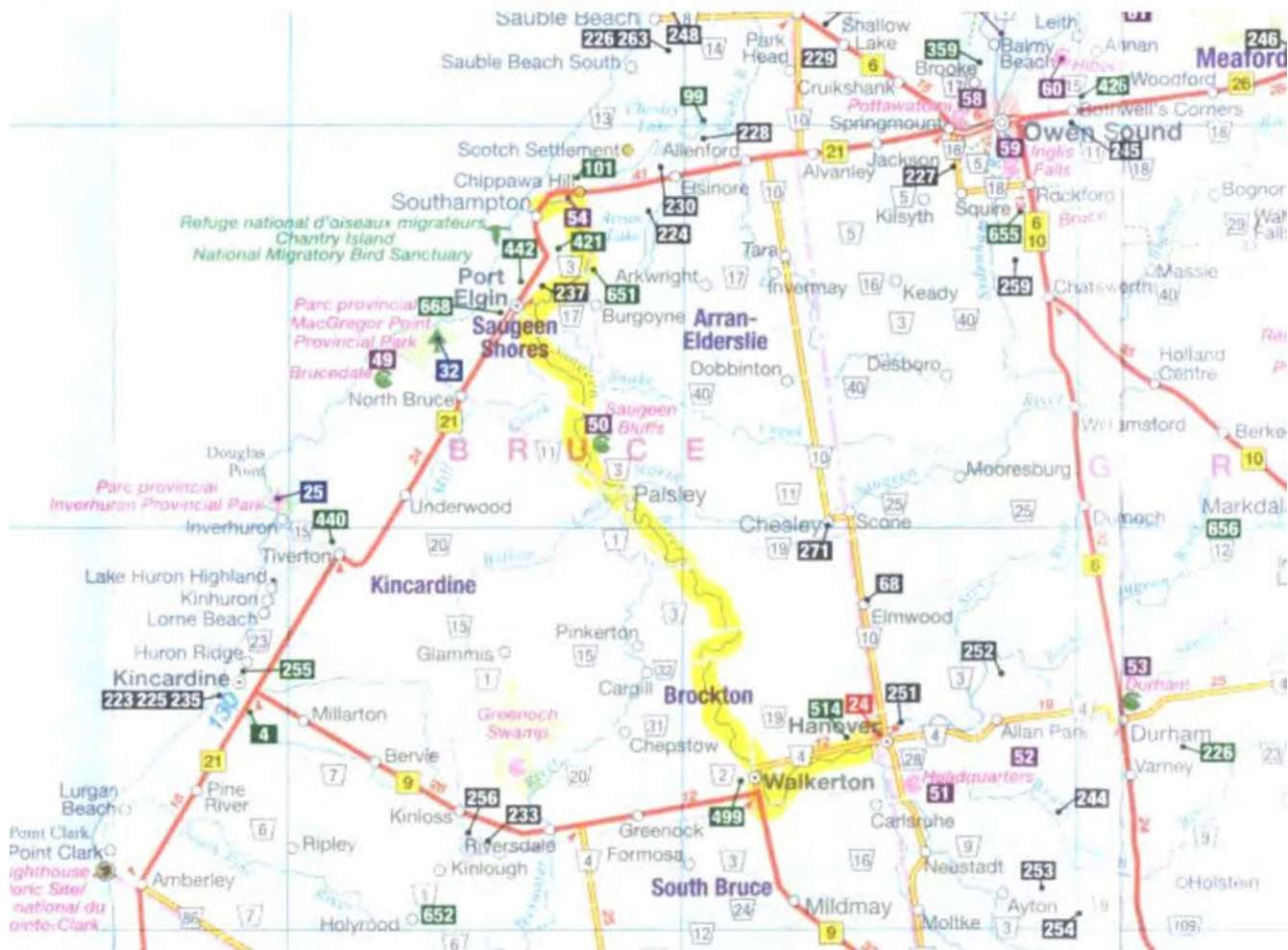

Figure C-1 Recreation Map–Saugeen River Canoe Route

Note. From *Ontario Recreation Map*, by MapArt Publishing Corporation, 2005, Oshawa, ON: Peter Heiler Ltd. Copyright 2005 by Mapmedia Corp.

| Canoe Routes | | | |
|---|-----------------|-----|---------|
| There are hundreds of other canoe routes in Ontario besides listed below. The best overall resource covering the routes is the Canoe Routes of Ontario , available at bookstores or from McLeod Stewart Inc. | | | |
| Bayfield River | M6-7 | R | C--C |
| Beaver River | J9-10 | R | A--CC |
| Big Creek | Q-R9 | R | C--C |
| Burnt River | G-H15 | L/R | B B B C |
| Charleston L.-Gananoque L. | J22 | L/R | B C C C |
| Dokis Loop | C10-11 | R/L | C B B B |
| French River | C8-11 | R | B B C B |
| Gibson-McDonald Loop | G11 | L/R | B B C B |
| Grand River | M-P10 P-Q11 Q12 | R | C C C C |
| Indian River | J-K16 | R | B C C C |
| Kishkebus Loop | G18-19 | L | C B B C |
| Lower Thames River | Q6-7 R5-6 | R | B--C |
| Magnetawan River Loop | D10-11 | L/R | B B B B |
| Maitland River | L7 M6 | R | B--C C |
| Mattawa River | B13-14 | R/L | C B B C |
| Mercer Lake-Little French River Loop | C10-11 | L/R | C A B B |
| Mississippi River | F21 G20-21 | L/R | B B B C |
| Mississippi River-Big Gull Lake Loop | G20 | L/R | C B B C |
| Moira River | J-K18 | R | B B C C |
| Nottawasaga River | J-L11 | R | B--C C |
| Ottawa River | B15-16 | L/R | C C C B |
| Pickering River Loop | C9-10 | R/L | B B B C |
| Rankin River | H7-8 | R/L | B B C C |
| Restoule-Upper French River Loop | C11 | L/R | C A B B |
| Saugeen River | J-K7 K8 | R | B--C C |
| Skootamatta River | H-J18 | R | B B C C |
| South Branch Muskoka River | F-G13 | R | C C C C |
| South Georgian Bay Loop | F11 | L/R | B B B C |
| Welland River | P11-13 | R | C C C C |
| Wildcat Lake Loop | F14-15 | L | C B B B |
| Wolf & Pickering Rivers | C10-11 | R/L | B B C C |

| | |
|------------------------|-------------------------|
| R=85-100% River Travel | R/L=50-84% River Travel |
| L=85-100% Lake Travel | L/R=50-84% Lake Travel |
| S=Sea Travel | |

| | |
|---------------------------|-------------------|
| Ratings: A=Most Difficult | B=Intermediate |
| C=Easiest | --=Not Applicable |

| | |
|-----------------------|----------------------|
| Column 1=River Travel | Column 2=Lake Travel |
| Column 3=Portages | Column 4=Remoteness |

Figure C-2 Recreation Map–
Canoe Route Information

Note. From *Ontario Recreation Map*, by MapArt Publishing Corporation, 2005, Oshawa, ON: Peter Heiler Ltd. Copyright 2005 by Mapmedia Corp.

| Conservation Areas | | | | | | | | |
|------------------------------|--------|----------------|---|---|---|---|---|---|
| 10 A.W. Campbell | D6 | .519-847-5357 | ✓ | ✓ | ✓ | ✓ | ✓ | ✓ |
| 61 Ainslie Wood | H9 | .519-376-3076 | ✓ | ✓ | ✓ | ✓ | ✓ | ✓ |
| 89 Albion Hills | L11 | .905-880-4855 | ✓ | ✓ | ✓ | ✓ | ✓ | ✓ |
| 52 Allan Park | K8 | .519-364-1255 | ✓ | ✓ | ✓ | ✓ | ✓ | ✓ |
| 26 Backus Heritage | R9-10 | .519-586-2201 | ✓ | ✓ | ✓ | ✓ | ✓ | ✓ |
| 67 Ball's Falls | P13 | .905-778-3135 | ✓ | ✓ | ✓ | ✓ | ✓ | ✓ |
| 147 Baxter | F23 | .613-692-3571 | ✓ | ✓ | ✓ | ✓ | ✓ | ✓ |
| 81 Belfountain | L11 | .519-927-5838 | ✓ | ✓ | ✓ | ✓ | ✓ | ✓ |
| 43 Belwood Lake | M10 | .519-843-2979 | ✓ | ✓ | ✓ | ✓ | ✓ | ✓ |
| 5 Big Bend | R6 | .519-354-7310 | ✓ | ✓ | ✓ | ✓ | ✓ | ✓ |
| 64 Binbrook | P11 | .905-692-3228 | ✓ | ✓ | ✓ | ✓ | ✓ | ✓ |
| 93 Black Creek Pioneer Vill. | M12 | .416-736-1733 | ✓ | ✓ | ✓ | ✓ | ✓ | ✓ |
| 94 Boyd | L12 | .905-851-0575 | ✓ | ✓ | ✓ | ✓ | ✓ | ✓ |
| 34 Brant | P10 | .519-752-2040 | ✓ | ✓ | ✓ | ✓ | ✓ | ✓ |
| 55 Bruce's Caves | H8 | .519-376-3076 | ✓ | ✓ | ✓ | ✓ | ✓ | ✓ |
| 97 Bruce's Mill | L13 | .905-887-5531 | ✓ | ✓ | ✓ | ✓ | ✓ | ✓ |
| 49 Brucedale | J7 | .519-389-4516 | ✓ | ✓ | ✓ | ✓ | ✓ | ✓ |
| 138 Buell's Creek | H23 | .613-546-4228 | ✓ | ✓ | ✓ | ✓ | ✓ | ✓ |
| 32 Byng Island | Q12 | .905-774-5755 | ✓ | ✓ | ✓ | ✓ | ✓ | ✓ |
| 4 C.M. Wilson | S5 | .519-354-7310 | ✓ | ✓ | ✓ | ✓ | ✓ | ✓ |
| 2 Cedar Creek Beach | T3 | .519-776-5209 | ✓ | ✓ | ✓ | ✓ | ✓ | ✓ |
| 15 Charles J. McEwen | P5 | .519-245-3710 | ✓ | ✓ | ✓ | ✓ | ✓ | ✓ |
| 65 Chippawa Creek | P-Q12 | .905-386-6387 | ✓ | ✓ | ✓ | ✓ | ✓ | ✓ |
| 73 Christie | N11 | .905-628-3060 | ✓ | ✓ | ✓ | ✓ | ✓ | ✓ |
| 96 Cold Creek | L12 | .416-661-6000 | ✓ | ✓ | ✓ | ✓ | ✓ | ✓ |
| 12 Coldstream | P6-7 | .519-245-3710 | ✓ | ✓ | ✓ | ✓ | ✓ | ✓ |
| 56 Colpo's Lookout | H8 | .519-376-3076 | ✓ | ✓ | ✓ | ✓ | ✓ | ✓ |
| 40 Conestogo Lake | M9 | .519-638-2873 | ✓ | ✓ | ✓ | ✓ | ✓ | ✓ |
| 70 Confederation Park | N12 | 1-888-319-HRCA | ✓ | ✓ | ✓ | ✓ | ✓ | ✓ |
| 161 Cooper Marsh | F26 | .613-347-1332 | ✓ | ✓ | ✓ | ✓ | ✓ | ✓ |
| 76 Crawford Lake | N11 | .905-854-0234 | ✓ | ✓ | ✓ | ✓ | ✓ | ✓ |
| 120 Crowe Bridge | J17 | .613-472-3137 | ✓ | ✓ | ✓ | ✓ | ✓ | ✓ |
| 84 D.A. Tiffin | J11-12 | .705-424-1479 | ✓ | ✓ | ✓ | ✓ | ✓ | ✓ |
| 7 Dalewood | O8 | .519-631-1270 | ✓ | ✓ | ✓ | ✓ | ✓ | ✓ |
| 25 Deer Creek | O9 | .519-875-2874 | ✓ | ✓ | ✓ | ✓ | ✓ | ✓ |
| 54 Denny's Dam | J7 | .519-364-1255 | ✓ | ✓ | ✓ | ✓ | ✓ | ✓ |
| 132 Depot Lakes | H20 | .613-476-7408 | ✓ | ✓ | ✓ | ✓ | ✓ | ✓ |
| 149 Dickerson Square | F23 | .613-692-3571 | ✓ | ✓ | ✓ | ✓ | ✓ | ✓ |
| 72 Dundas Valley | P11 | .905-627-1233 | ✓ | ✓ | ✓ | ✓ | ✓ | ✓ |
| 53 Durham | K9 | .519-369-2074 | ✓ | ✓ | ✓ | ✓ | ✓ | ✓ |
| 158 Eau Claire Gorge | B14 | .705-474-5420 | ✓ | ✓ | ✓ | ✓ | ✓ | ✓ |
| 87 Edenvale | J11 | .705-424-1479 | ✓ | ✓ | ✓ | ✓ | ✓ | ✓ |
| 41 Elora Gorge | M10 | .519-846-9742 | ✓ | ✓ | ✓ | ✓ | ✓ | ✓ |
| 42 Elora Quarry | M10 | .519-846-5234 | ✓ | ✓ | ✓ | ✓ | ✓ | ✓ |
| 105 Enniskillen | L14 | .905-579-0411 | ✓ | ✓ | ✓ | ✓ | ✓ | ✓ |
| 62 Epping Lookout | J9 | .519-376-3076 | ✓ | ✓ | ✓ | ✓ | ✓ | ✓ |
| 63 Eugenia Falls | K9 | .519-376-3076 | ✓ | ✓ | ✓ | ✓ | ✓ | ✓ |
| 45 Falls Reserve | M6 | 1-877-FALLSCA | ✓ | ✓ | ✓ | ✓ | ✓ | ✓ |
| 21 Fanshawe | P7 | .519-451-2800 | ✓ | ✓ | ✓ | ✓ | ✓ | ✓ |
| 69 Fifty Point | P12 | .905-643-8833 | ✓ | ✓ | ✓ | ✓ | ✓ | ✓ |
| 131 Flinton | H19 | .613-476-7408 | ✓ | ✓ | ✓ | ✓ | ✓ | ✓ |
| 143 Foley Mountain | H21 | .613-692-3571 | ✓ | ✓ | ✓ | ✓ | ✓ | ✓ |
| 46 Galbraith | M8 | .519-335-3557 | ✓ | ✓ | ✓ | ✓ | ✓ | ✓ |
| 109 Ganaraska Forest | K15 | .905-885-8173 | ✓ | ✓ | ✓ | ✓ | ✓ | ✓ |
| 110 Garden Hill | K-L15 | .905-885-8173 | ✓ | ✓ | ✓ | ✓ | ✓ | ✓ |
| 88 Glen Haffy | L11 | .905-584-2922 | ✓ | ✓ | ✓ | ✓ | ✓ | ✓ |
| 111 Goodrich-Loomis | K17 | .613-394-4829 | ✓ | ✓ | ✓ | ✓ | ✓ | ✓ |
| 136 Gould Lake | J20 | .613-546-4228 | ✓ | ✓ | ✓ | ✓ | ✓ | ✓ |
| 152 Gray's Creek | F25 | .613-938-3398 | ✓ | ✓ | ✓ | ✓ | ✓ | ✓ |
| 98 Greenwood | L13 | .905-683-2951 | ✓ | ✓ | ✓ | ✓ | ✓ | ✓ |
| 38 Guelph Lake | M10 | .519-824-5061 | ✓ | ✓ | ✓ | ✓ | ✓ | ✓ |
| 29 Haldimand | Q11 | .905-776-2700 | ✓ | ✓ | ✓ | ✓ | ✓ | ✓ |
| 104 Harmony Valley | L14 | .905-579-0411 | ✓ | ✓ | ✓ | ✓ | ✓ | ✓ |
| 122 Harry Smith | K18 | .613-476-7408 | ✓ | ✓ | ✓ | ✓ | ✓ | ✓ |
| 113 Hastings | J-K16 | .613-394-4829 | ✓ | ✓ | ✓ | ✓ | ✓ | ✓ |
| 28 Hay Creek | Q10 | .519-428-4622 | ✓ | ✓ | ✓ | ✓ | ✓ | ✓ |
| 51 Headquarters | K8 | .519-364-1255 | ✓ | ✓ | ✓ | ✓ | ✓ | ✓ |
| 90 Heart Lake | M11 | .905-846-2494 | ✓ | ✓ | ✓ | ✓ | ✓ | ✓ |
| 103 Heber Down | L14 | .905-579-0411 | ✓ | ✓ | ✓ | ✓ | ✓ | ✓ |
| 60 Hibou | H8 | .519-376-3076 | ✓ | ✓ | ✓ | ✓ | ✓ | ✓ |
| 151 High Falls | E24 | .613-984-2948 | ✓ | ✓ | ✓ | ✓ | ✓ | ✓ |
| 16 Highland Glen | P5 | .519-245-3710 | ✓ | ✓ | ✓ | ✓ | ✓ | ✓ |
| 3 Hillman Marsh | T4 | .519-776-5209 | ✓ | ✓ | ✓ | ✓ | ✓ | ✓ |
| 78 Hilton Falls | M-N11 | .905-854-0262 | ✓ | ✓ | ✓ | ✓ | ✓ | ✓ |
| 160 Holiday Beach | T2 | .519-776-5209 | ✓ | ✓ | ✓ | ✓ | ✓ | ✓ |
| 117 Hope Mill | K16 | .705-750-0545 | ✓ | ✓ | ✓ | ✓ | ✓ | ✓ |
| 57 Indian Falls | H8 | .519-376-3076 | ✓ | ✓ | ✓ | ✓ | ✓ | ✓ |
| 59 Inglis Falls | J8 | .519-376-3076 | ✓ | ✓ | ✓ | ✓ | ✓ | ✓ |
| 162 Jessups Falls | E24 | .613-938-3611 | ✓ | ✓ | ✓ | ✓ | ✓ | ✓ |
| 1 John R. Park Homestead | T3 | .519-776-5209 | ✓ | ✓ | ✓ | ✓ | ✓ | ✓ |
| 140 K and P Trail | F20 | .613-259-2421 | ✓ | ✓ | ✓ | ✓ | ✓ | ✓ |
| 79 Kelso | M-N11 | .905-878-5011 | ✓ | ✓ | ✓ | ✓ | ✓ | ✓ |
| 114 Ken Reid | J14 | .705-328-2271 | ✓ | ✓ | ✓ | ✓ | ✓ | ✓ |

Figure C-3 Recreation Map–
Conservation Area Information

Note. From *Ontario Recreation Map*, by MapArt Publishing Corporation, 2005, Oshawa, ON: Peter Heiler Ltd. Copyright 2005 by Mapmedia Corp.

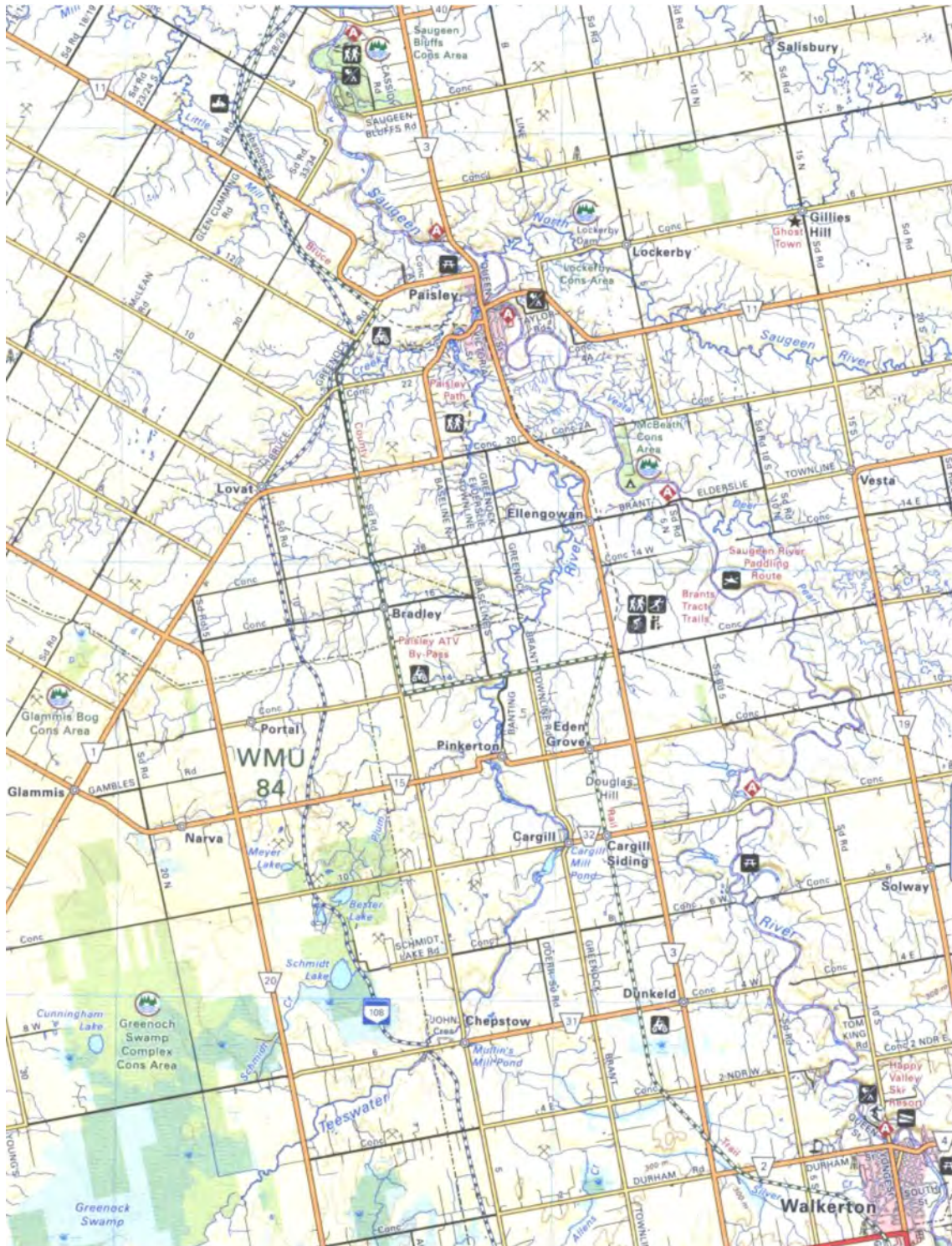

Figure C-4 Backroad Mapbook–Walkerton

Note. From *Southwestern Ontario: Backroad Mapbook* (p. 49), by C. Minutillo, 2008, Burnaby, BC: Mussio Ventures Ltd. Copyright 2008 by Mussio Ventures Ltd.

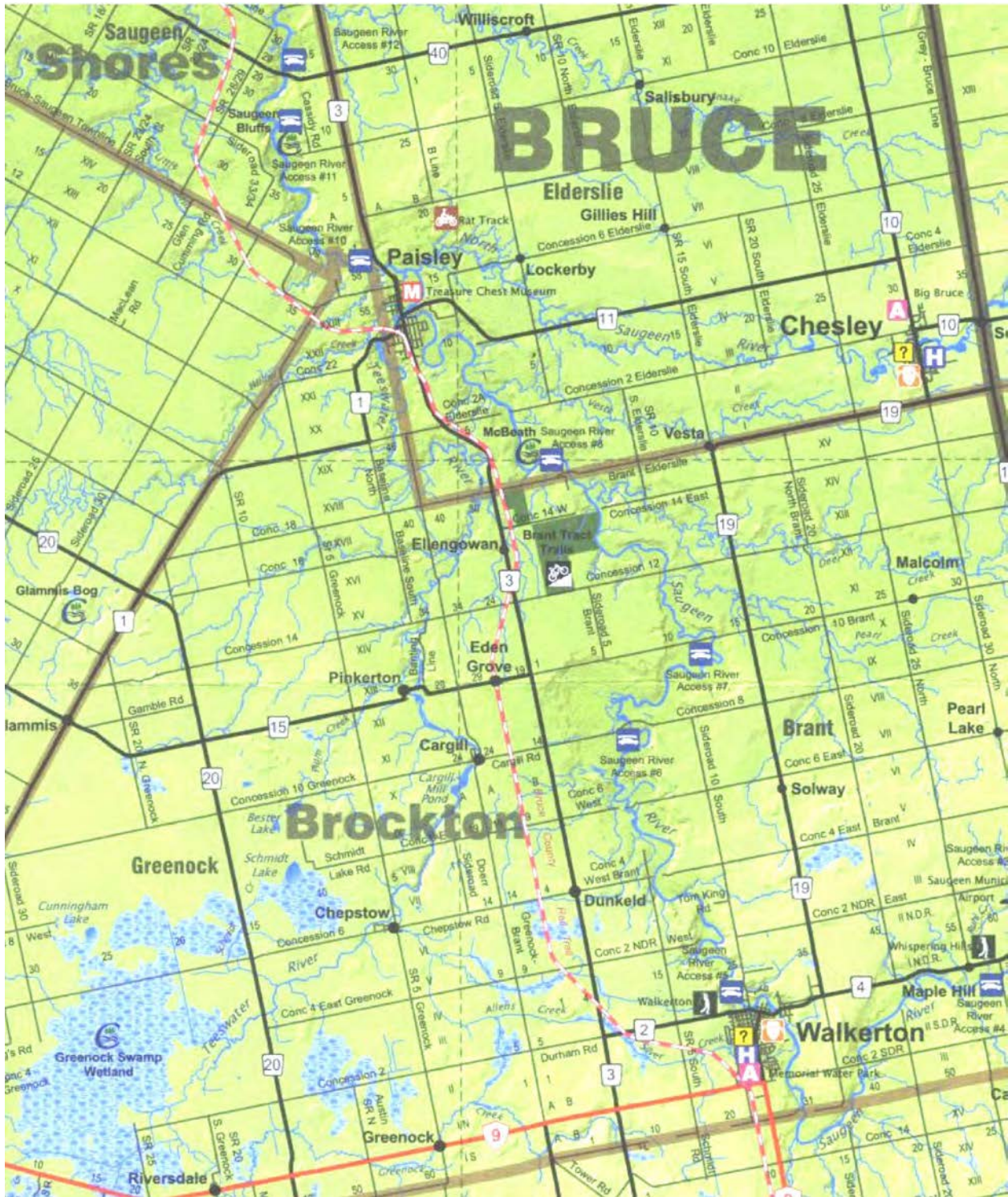

Figure C-5 Grey-Bruce Official Visitor Map

Note. From *Grey-Bruce Official Visitor Map*, by County of Bruce, 2008, London, ON: Charterhouse Printing. Copyright 2008 by County of Bruce

CAMPGROUND INFORMATION

| Campground | Location | Rates | General Information / Rules |
|---|--|--|---|
| Lobies Park | P.O. Box 850, 20 Hannah Street, Walkerton, Ontario N0G 2V0 Tel: 519-881-3435 | Non-serviced sites: <ul style="list-style-type: none"> per day \$20 per week \$110 per month \$400 Group camping: <ul style="list-style-type: none"> per night \$120 | <ul style="list-style-type: none"> Park quiet hours are 2300 hrs–0800 hrs. Campsite check out time is 1100 hrs; check in is at 1400 hrs. Campers shall keep their respective site in a clean and tidy order and all pets must be tied and / or on a leash at all times. Campfires must be controlled in a pit area and supervised at all times. All fires must be extinguished by 0100 hrs. |
| Rotary Riverside Campground | 416 Water Street, Paisley, Ontario N0G 2N0 Tel: 519-353-5575 | Contact campground for campsite rates and availability. | |
| McBeath Conservation Area | 9 km upstream of the Village of Paisley along the Saugeen River. Tel: 519-353-5142 Email: kempwelch@bmts.com | Contact the Friends of McBeath for campsite rates and availability. | <ul style="list-style-type: none"> Group and family campsites are available for up to 75 people. This site is accessible only by water. There is no public vehicle access. The conservation area is designated a glass-free zone. |
| Saugeen Bluffs Conservation Area | 132 Saugeen Bluffs Rd, 8 km north of Paisley off Bruce Rd 3. Tel: 519-364-1255 | Non-serviced sites: <ul style="list-style-type: none"> per day \$27 per week \$165 Group camping: <ul style="list-style-type: none"> per person per night \$4.50 | <ul style="list-style-type: none"> There are over 200 spacious sites within the conservation area. The campground features two picnic shelters, laundry facilities, a store and a wading pool. There is a fully developed trail system in the conservation area. An alcohol ban exists in the park on the May long weekend. Campers are not permitted to bring their own firewood. |
| Hidden Valley Camp | RR #5, Paisley, Ontario N0G 2N0 Tel: 519-353-4100 | Contact campground for campsite rates and availability. | |

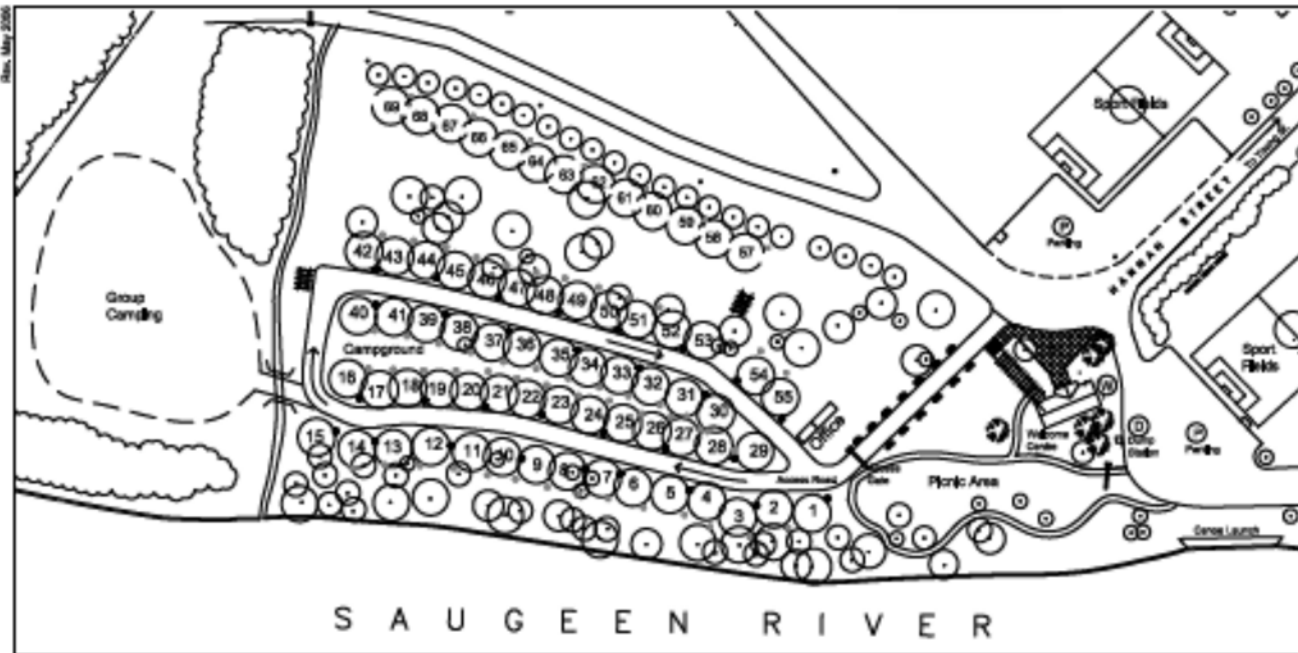

Figure D-1 Lobies Campground

Note. From *Lobies Campground* by Municipality of Brockton. Retrieved March 27, 2009, from <http://town.walkerton.on.ca/Municipality/Lobies.html>

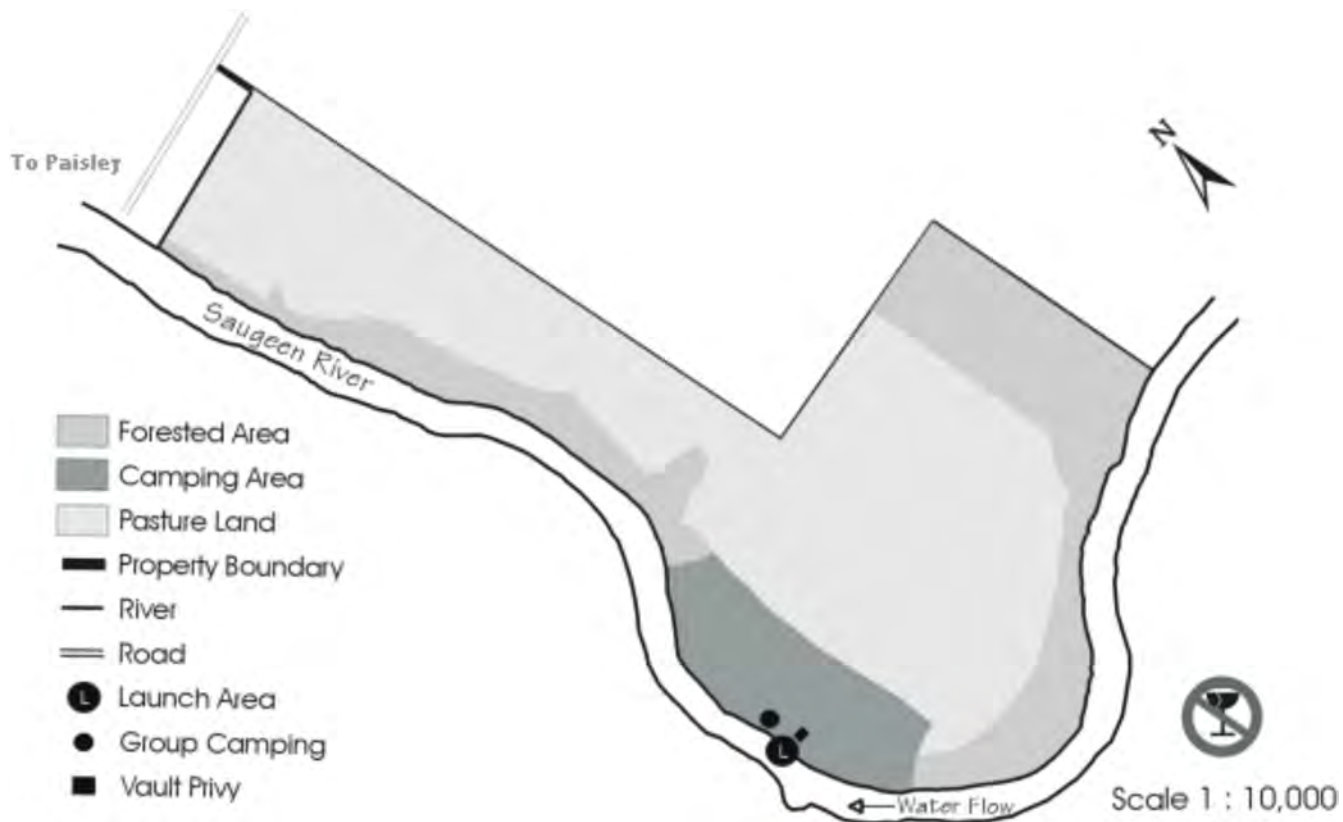

Figure D-2 McBeath Conservation Area Map

Note. From *McBeath Conservation Area* by Saugeen Conservation.
Retrieved March 27, 2009, from <http://www.svca.on.ca/ca-mcbeath.htm>

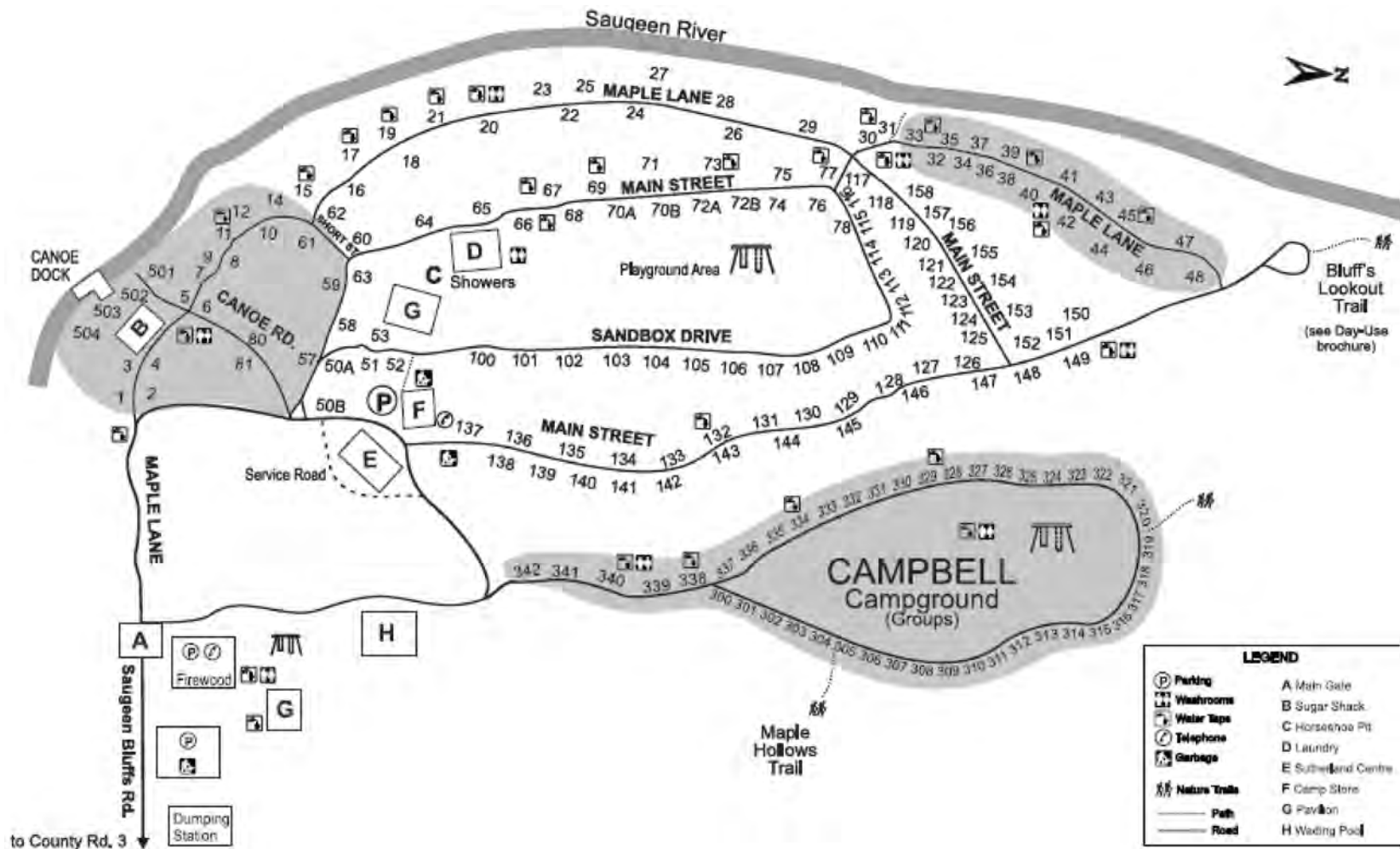

Figure D-3 Saugeen Bluffs Conservation Area Campground Map

Note. From *Campsite Map* by Saugeen Conservation. Retrieved March 27, 2009, from <http://www.svca.on.ca/ca-bluffs2b.htm>

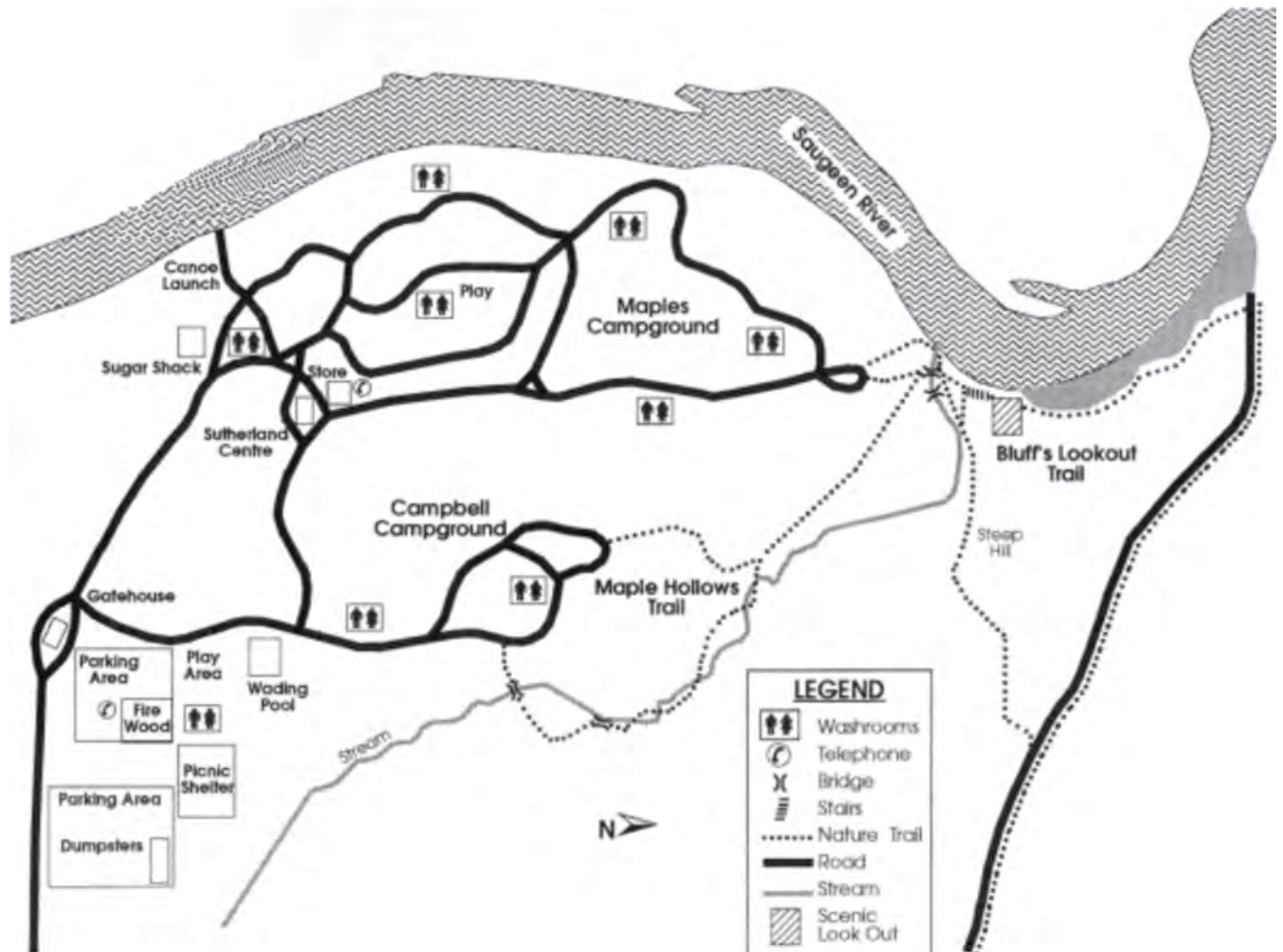

Figure D-4 Saugeen Bluffs Conservation Area Trail Map

Note. From *Trail Map* by Saugeen Conservation. Retrieved March 27, 2009, from <http://www.svca.on.ca/ca-bluffs4.htm>

THIS PAGE INTENTIONALLY LEFT BLANK

MOUNTAIN BIKE TRAILS INFORMATION

Brant Tract Trails

Brant Tract Trails has more than 20 km of hand cut single-track trails. Trails range from tight and technical to open and flowing concepts and can satisfy the beginner to the more advanced mountain biker. The property provides mountain bikers with spectacular views of valleys, wetlands and tower pines.

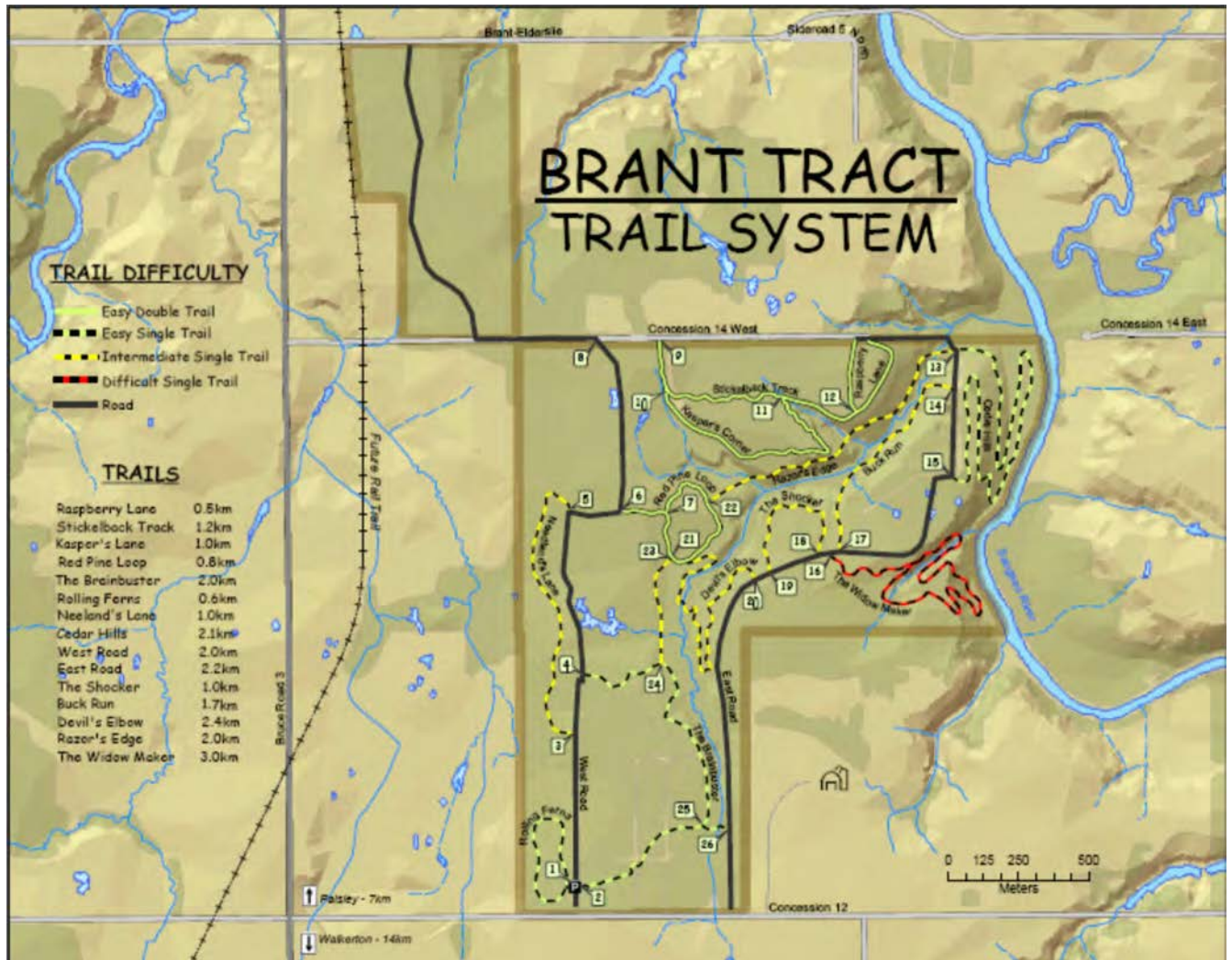

Figure E-1 Brant Tract Trail System

Note. From *Brant Tract Trails* by Mountain Bike the Bruce. Retrieved March 27, 2009, from <http://www.mtbthebruce.com/brantusage.php>

THIS PAGE INTENTIONALLY LEFT BLANK

CANOE ROUTE INFORMATION

Saugeen Access Point #5 (Lobie's Park) to Saugeen Access Point #6 (Brant Conc. 8)

This is the longest section of the Saugeen River uninterrupted by bridges. The river winds out of Walkerton around several islands. In the spring, paddlers may choose one of several channels around these scenic islands but as summer goes on it is wise to stay to the deeper main channel. The Saugeen meanders through a broad valley between densely forested hills. In places, the river actually cuts into these hills, creating tall clay-sand bluffs, which provide a home for thousands of swallows, kingfishers, and other cliff-dwelling birds. Approaching the bridge on the Brant Concession 8, the bluffs diminish and give way to mixed farmland and forest. In this area it is possible to see deer and fox along the banks.

Saugeen Access Point #6 (Brant Conc. 8) to Saugeen Access Point #7 (Brant Conc. 10)

As the Saugeen progresses toward Lake Huron, the woodlands and bluffs of the upper areas give way to the rolling farmland of the middle sections. It is common to see cattle, horses and other livestock coming down to the river for a drink. The river slowly meanders through this mixed agricultural and forested land, this mixed habitat is ideal for the deer populations in the area and therefore sightings are common. A set of power lines crosses the river in this section. These mark the halfway point of the Hanover-Southampton portion of the Saugeen River.

Saugeen Access Point #7 (Brant Conc. 10) to Saugeen Access Point #8 (Brant-Elderslie Town Line)

This section ventures back in to woodlands, with some spots of agricultural land. The river continues on its slow relaxed pace through several sharp bends before this section comes to an end at a steel covered bridge just outside the hamlet of Ellengowan. This spot makes for an excellent put-in point for paddlers looking for a relaxed two day trip (6 hrs per day) to Southampton as well as a nice lunch spot for those out for a day trip on the middle section of the Saugeen.

Saugeen Access Point #8 (Brant-Elderslie Town Line) to Saugeen Access Point #9 (Paisley Hose Tower Dock)

The first section before Paisley passes through more mixed farm and forest. Shortly after the Ellengowan bridge is McBeath Conservation Area. From McBeath, the river takes a winding path to Paisley, coming right up beside the town and then swinging back away before making its way into the village. Several canoe docks line the river as it travels through the heart of the town. One of these is the Rotary Park: a scenic campground in downtown Paisley. For those looking for a lunch break, a canoe dock is situated just below the restored Fire Hose Tower, before the set of bridges in Paisley.

Saugeen Access Point #9 (Paisley Hose Tower Dock) to Saugeen Access Point #10 (Bridge North of Paisley)

Proceeding past this dock and under the bridge, paddlers will note the Teeswater River flowing over a dam and joining the Saugeen. Shortly downstream, the North Saugeen also joins the main river. Finally upon exiting Paisley, paddlers will pass under Bruce County Road 3 and come to a popular canoe launch at the north end of Paisley.

Saugeen Access Point #10 (Bridge North of Paisley) to Saugeen Access Point #11 (Saugeen Bluffs Conservation Area)

After leaving this canoe launch behind, the Saugeen picks up speed slightly and winds its way down to the Saugeen Bluffs Conservation Area. Through this trip, paddlers will notice the river's banks becoming progressively higher until they peak at about 100–115 ft. at the Saugeen Bluffs. The Saugeen Bluffs Conservation Area is a good place to spend the night or have a lunch break. The Conservation Area offers several canoe launch sites beside the river for canoe trippers for a reasonable fee.

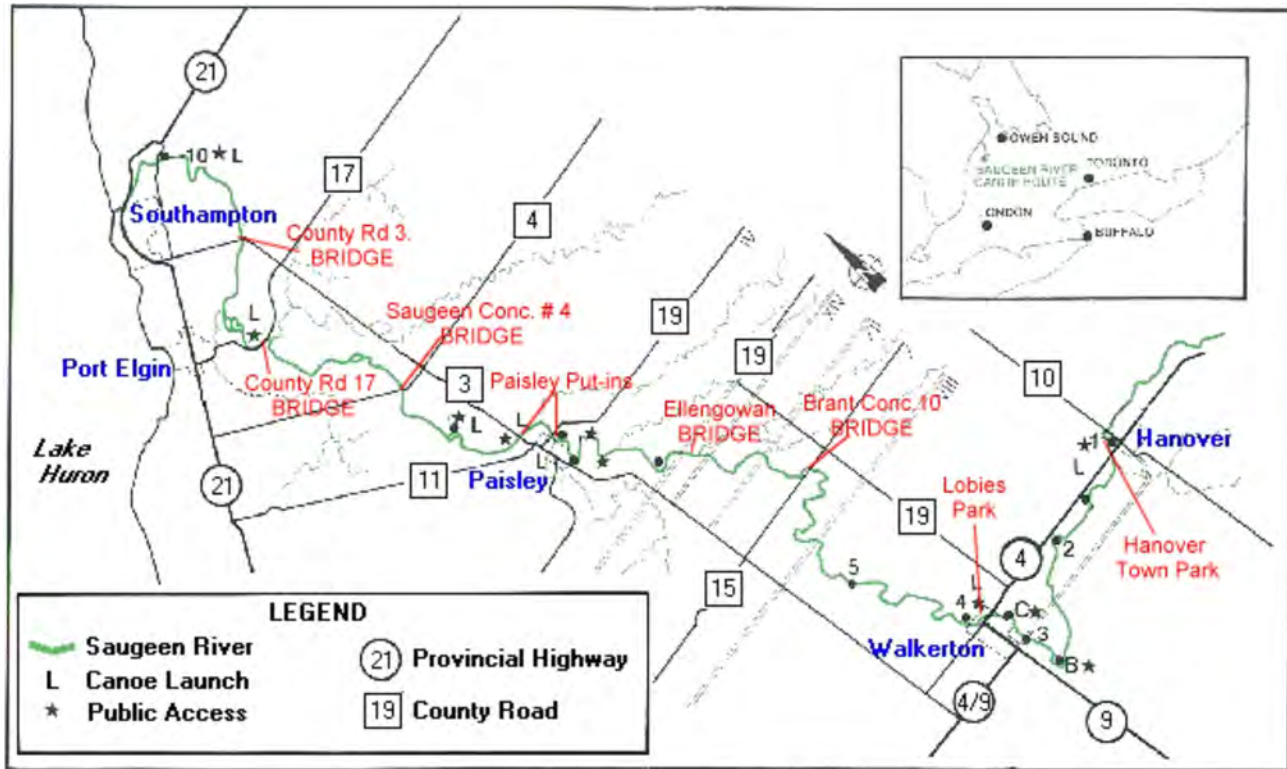

Figure F-1 Saugeen River Canoe Route

Note. From *Saugeen River Canoe Route* by Thorncrest Outfitters, Copyright 2005 by Thorncrest Outfitters. Retrieved March 27, 2009, from <http://www.thorncrestoutfitters.com/images/saugeenriver1.gif>



Figure F-2 Saugeen River Canoe Route Access Points

Note. From *Saugeen River Canoe Route Map* by Saugeen Conservation.
Retrieved March 27, 2009, from <http://www.svca.on.ca/canoeroutes/map.htm>



Figure F-3 Saugeen River Canoe Route Map Legend

Note. From *Saugeen River Canoe Route* by Thorncrest Outfitters, Copyright 2005 by Thorncrest Outfitters. Retrieved March 27, 2009, from <http://www.thorncrestoutfitters.com/paddling/maplegend.htm>

Location: Along the west side of Young Street, north of Durham Street.

Facilities: Dock, parking, flush toilets, group camping and picnic shelters.

Description: There is a dock and a floating dock at the river access point. Parking is available at the campground. There are no signs to mark the facility.



Figure F-4 Saugeen Access Point #5–Lobies Park Campground

Note. From *Saugeen River Canoe Route* by Thorncrest Outfitters, Copyright 2005 by Thorncrest Outfitters. Retrieved March 27, 2009, from <http://www.thorncrestoutfitters.com/paddling/saugeenmap3.htm>

Location: Brant Concession #8 is located 0.2 km west of Sideroad #10 or 2.5 km east of Bruce Rd #3.

Facilities: River access, parking and garbage cans.

Description: River access is 80 m from the parking area. There is a 3 m high bank on the northeast side of the bridge. Roadside parking is on the east side of the bridge.

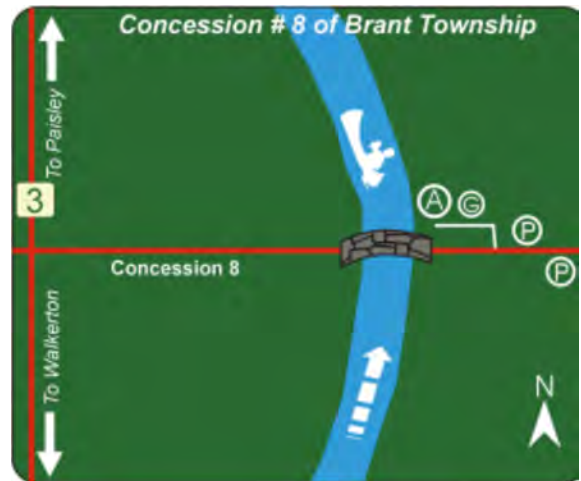

Figure F-5 Saugeen Access Point #6–Concession #8 of Brant Township

Note. From *Saugeen River Canoe Route* by Thorncrest Outfitters, Copyright 2005 by Thorncrest Outfitters. Retrieved March 27, 2009, from <http://www.thorncrestoutfitters.com/paddling/saugeenmap4.htm>

Location: Brant Concession #10 is 1 km west of Bruce Rd #19 or 5 km east of Bruce Rd #3.

Facilities: River access and parking.

Description: River access is 75 m from the parking area at the northeast side of the bridge. Roadside parking is east of the bridge or southwest of the bridge.

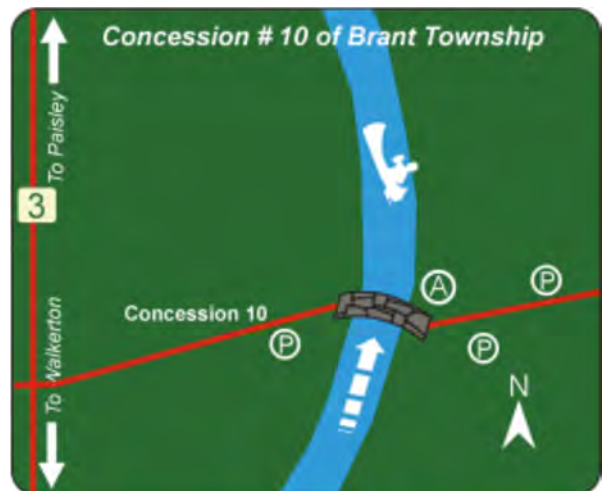

Figure F-6 Saugeen Access Point #7–Concession #10 of Brant Township

Note. From *Saugeen River Canoe Route* by Thorncrest Outfitters, Copyright 2005 by Thorncrest Outfitters. Retrieved March 27, 2009, from <http://www.thorncrestoutfitters.com/paddling/saugeenmap5.htm>

Location: The Ellengowan bridge is located 2 km east of Bruce Rd #3 on the Elderslie / Brant Townline.

Facilities: River access, parking and garbage cans.

Description: River access is northwest of the bridge. The bank is 20 m high and the shore can be slippery. Parking is on the west side of the bridge. The Saugeen Valley Conservation Authority has a destination sign under the bridge.



Figure F-7 Saugeen Access Point #8—Ellengowan Bridge - Elderslie / Brant Townline

Note. From *Saugeen River Canoe Route* by Thorncrest Outfitters, Copyright 2005 by Thorncrest Outfitters. Retrieved March 27, 2009, from <http://www.thorncrestoutfitters.com/paddling/saugeenmap6.htm>

Location: The access point is located behind the old fire station, next to Thompson Brother's Furniture, on Water Street, east of Queen Street.

Facilities: River access, parking, garbage cans and picnic area.

Description: River access is 15 m down the bank to the floating dock. Roadside parking is limited, however there is a town parking lot behind the old hotel.



Figure F-8 Saugeen Access Point #9—Paisley Downtown

Note. From *Saugeen River Canoe Route* by Thorncrest Outfitters, Copyright 2005 by Thorncrest Outfitters. Retrieved March 27, 2009, from <http://www.thorncrestoutfitters.com/paddling/saugeenmap7.htm>

Location: The bridge is located north of Paisley on Bruce Rd #3.

Facilities: River access, parking, garbage cans and picnic area.

Description: River access is 50 m down a gentle slope to the rocky shore. A County of Bruce sign is at the side of the road.

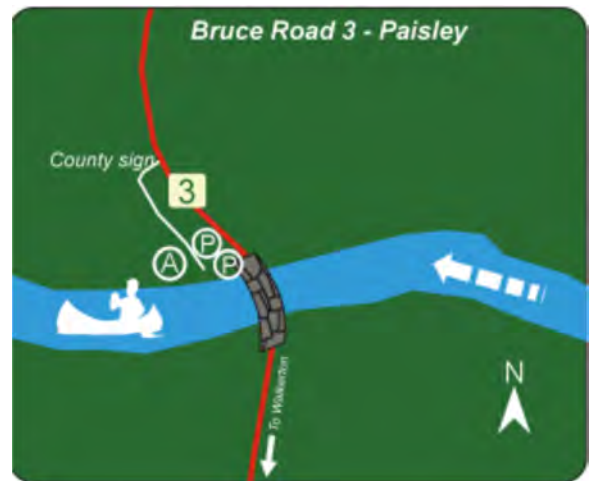

Figure F-9 Saugeen Access Point #10–Paisley North End

Note. From *Saugeen River Canoe Route* by Thorncrest Outfitters, Copyright 2005 by Thorncrest Outfitters. Retrieved March 27, 2009, from <http://www.thorncrestoutfitters.com/paddling/saugeenmap8.htm>

THIS PAGE INTENTIONALLY LEFT BLANK

HOSPITAL INFORMATION

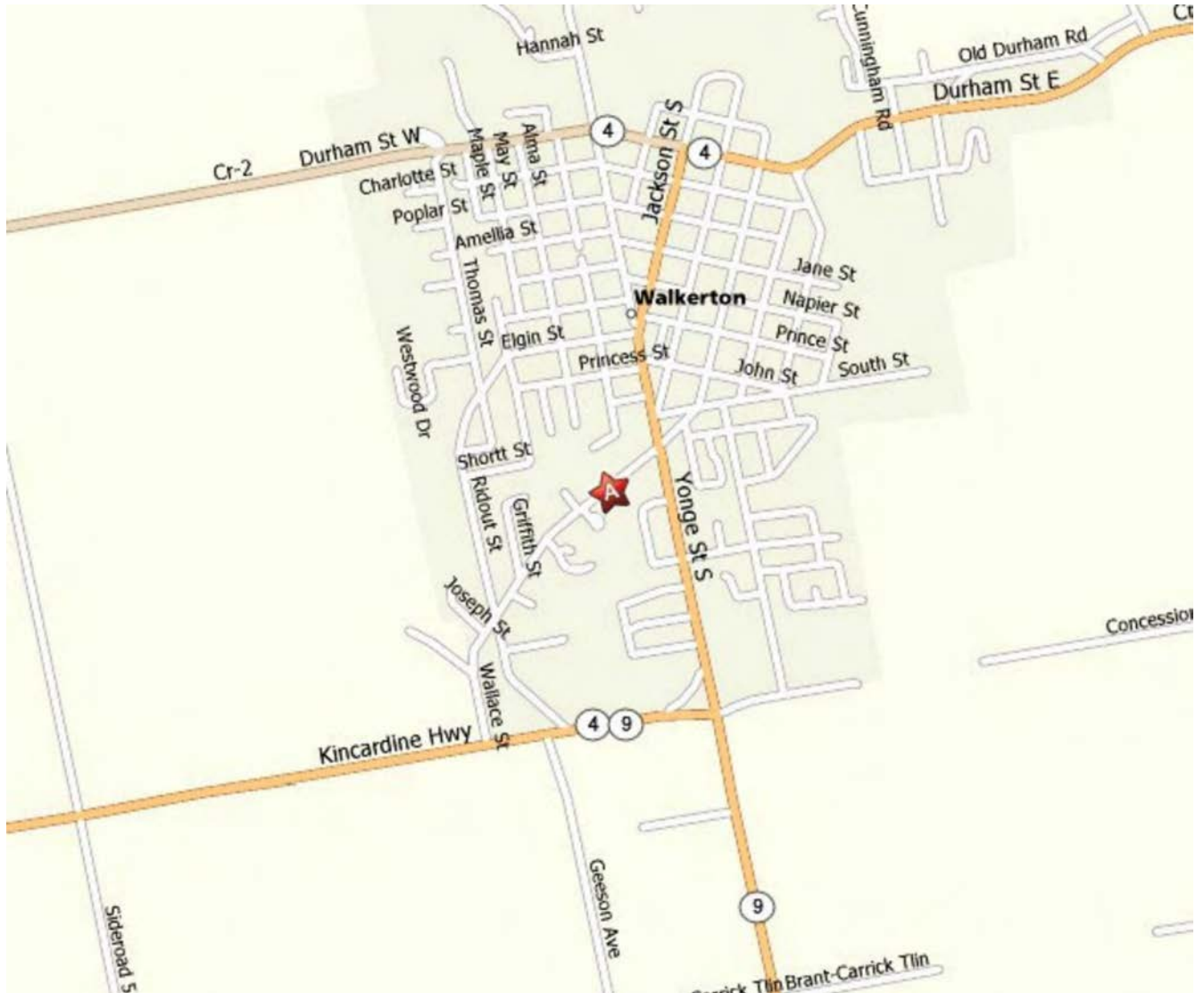

Figure G-1 County of Bruce General Hospital, Walkerton, Ontario

Note. From *Maps* by MapQuest, Copyright 2009 by MapQuest Inc. Retrieved April 1, 2009, from <http://www.mapquest.com/maps?city=Walkerton&state=ON&address=21+McGivern+St.+W.%2C+>



Figure G-2 Chesley and District Hospital, Chesley, Ontario

Note. From *Maps by MapQuest*, Copyright 2009 by MapQuest Inc. Retrieved April 1, 2009, from <http://www.mapquest.com/maps?city=Chesley&state=ON&address=39-2nd+Street+Se>

COMPLETED SECTION 2 OF THE EXPEDITION PLANNING BOOKLET

IDENTIFY EXPEDITION ROUTE PLANNING RESOURCES

| Reference Materials | Organizations / Authorities |
|--|---------------------------------------|
| Ontario Recreation Map | Ontario Parks |
| Topographical maps–Markdale, Collingwood, Goderich, Lucknow, Wingham, Chesley, Walkerton and Wiarton | Saugeen Valley Conservation Authority |
| Canadian Canoe Routes–www.myccr.com | Grey Sauble Conservation Authority |
| Ontario Trails Council–www.ontariotrails.on.ca | Bruce Trail Association |
| <i>Backroad Map Book–Southwestern Ontario</i> | Maitland Conservation Authority |
| <i>A Paddlers Guide to Wilderness Weekend Adventures</i> by Kevin Callan | |
| <i>A Paddles Guide to The Rivers of Ontario and Quebec</i> by Kevin Callan | |
| MapQuest | |

IDENTIFY FACTORS TO CONSIDER WHEN SELECTING AN EXPEDITION ROUTE

Selecting an Expedition Location Comparison Chart

| | Location #1 | Location #2 | Location #3 |
|---|---|---|---|
| | Walkerton | Wingham | Thornbury |
| What is the distance to and from the location? | Niagara Falls–231 km Windsor–346.45 km | Niagara Falls–228.07 km Windsor–313 km | Niagara Falls–256.84 km Windsor–444.02 km |
| How long does it take to travel to and from the location? | Niagara Falls–3.15 hours Windsor–4.46 hours | Niagara Falls–3 hours Windsor–4.10 hours | Niagara Falls–3.17 minutes Windsor–5.35 minutes |
| How long will it take to get to or receive emergency services? | Hospitals located in Chesley, Walkerton and Hanover. Furthest distance is 15 km. | Hospitals located in Wingham and Goderich. Furthest distance is 20 km. | Hospitals located in Markdale, Collingwood and Meaford. Furthest distance is 25 km. |
| Is there adequate space at start and end points for drop-off of personnel and equipment? | Yes. Various points in area for start and end points. | Yes. Various points in area for start and end points. | Yes. Various points in area for start and end points. |
| Can the distance requirements for mode of travel #1 be met? | Saugeen River—Walkerton to Paisley—39 km—earlier take-out points available. | Maitland River—Wingham to Auburn—25 km—earlier take-out points available. | Beaver River—Kimberly to Heathcote—25 km—earlier take-out points available. |
| Can the terrain requirements for mode of travel #1 be met? | Mostly flatwater, some swifts depending on time of year, lift-overs and sweepers. | Flatwater, some swifts depending on time of year, lift-overs. | Flatwater. |

| | Location #1 | Location #2 | Location #3 |
|--|---|---|---|
| Can the distance requirements for mode of travel #2 be met? | Brant Tract Trail System— over 25 km of trails. Roads leading to Brant Tract increase distance. | Carrick Tract Trail System—over 13 km of trails. Roads leading to Carrick Tract increase distance. | Kolapore Uplands Wilderness Ski Trails— over 30 km of trails. Roads leading to Kolapore Ski Trails increase distance. |
| Can the terrain requirements for mode of travel #2 be met? | Novice double- and single- track trails, intermediate single-track trails, dirt roads and paved roads. | Novice double- and single-track trails, intermediate single-track trails, dirt roads and paved roads. | Novice double- and single-track trails, intermediate single-track trails, dirt roads and paved roads. |
| Are there a number of campsites / rest stops available in the area? | Two Conservation Area campgrounds and three privately owned campground. | Four privately owned campsites and one Conservation Area campground | Two privately owned campgrounds. |
| What are the associated costs of using the area? | Costs for campsites are between \$15 and \$30 per night. Group rates are available. | Costs for campsites are between \$12 and \$30 per night. Group rates are available. | Costs for campsites are between \$10 and \$25 per night. Group rates are available. |
| What are the procedures to gain access to use the area? | Contact Grey Bruce Conservation Authority. | Contact Maitland Valley Conservation Authority and Grey Bruce Conservation Authority. | Contact Grey Sable Conservation Authority. |
| Are there any limitations on group sizes? | No limits - just dependent on availability of campsites. | No limits - just dependent on availability of campsites. | No limits - just dependent on availability of campsites. |
| Are there any restricted camping areas? | Can only camp in designated campgrounds. Rest stops can occur at campgrounds, conservation areas and crown land. No stopping on private land. | Can only camp in designated campgrounds. Rest stops can occur at campgrounds, conservation areas and crown land. No stopping on private land. | Can only camp in designated campgrounds. Rest stops can occur at campgrounds, conservation areas and crown land. No stopping on private land. |

Chosen location: Location #1

Reasons for choosing location: Location #1 provided the best area to meet the goals, objectives and guidelines of the expedition.
There are a variety of campgrounds in the area that will accommodate larger groups. The Brant Tract Trails will provide an excellent area for mountain biking. Many resources exist to assist with planning the route.

DEVELOP AN EXPEDITION ROUTE

Length of the expedition: **2 nights / 3 days (Friday Evening to Sunday Afternoon)** **2 nights / 3 days (Friday Evening to Sunday Afternoon)**

| | Route #1 | Route #2 |
|--|---|--|
| Drop-off point and campsite. | Saugeen Access Point #5, Lobie's Park, Yonge Street North, Walkerton, ON (GR 877 868). Campsite at Lobie's Park, Yonge Street North, Walkerton, ON. GR 877 868 | Saugeen Access Point #11, Saugeen Bluffs Conservation Area, North of Paisley, 1 km west off Bruce Rd 3 (GR 748 109). Campsite at Saugeen Bluffs Conservation Area, North of Paisley, 1 km west off Bruce Rd 3 (GR 748 109). |
| Mode(s) of travel day #1. | <ul style="list-style-type: none"> Canoe the Saugeen River from Saugeen Access Point #5 (GR 877 868) to Saugeen Access Point #6 (845 947). Mountain bike to Paisley Rotary Campground (GR 782 059) along the road and the rail trail. | <ul style="list-style-type: none"> Mountain bike from Saugeen Bluffs Conservation Area (GR 748 109) to Brant Tract Trails (GR 822 982). Mountain bike from Brant Tract Trails (GR 822 982) to Paisley Rotary Campground (GR 782 059) along the road. |
| Mode of travel change point(s) for day #1, if required. | Saugeen Access Point #6–Concession 8, Brant Twp, 2 km East of Hwy 3. | None. |
| Possible lunch locations for day #1. | <ul style="list-style-type: none"> Picnic area along the river - North of Concession 6 (GR 843 928). Saugeen Access Point #6 (GR 845 947). | <ul style="list-style-type: none"> Saugeen Access Point # 9, Paisley Hose Tower dock, east of Bruce Rd 3 and Bruce Rd 11 intersection (GR 782 059). Brant Tract Trails (GR 822 982). |

| | Route #1 | Route #2 |
|--|---|---|
| Possible rest-stop / re-supply locations for day #1. | <ul style="list-style-type: none"> Saugeen River, near Concession 4, West Brant, east of the town of Dunkeld (GR 850 904). Rail trail, Concession 14 and Bruce Rd 3 (GR 812 001). | <ul style="list-style-type: none"> Saugeen Access Point #9 (GR 782 059). Brant Tract Trails (GR 822 982). |
| Evacuation route(s) for day #1. | <ul style="list-style-type: none"> Canoe - move to nearest road access takeout and then proceed to County of Bruce General Hospital, 21 McGiven St W., Walkerton, ON (GR 877 853). Mountain Bike - move from rail trail to main road and then proceed to Chesley and District Hospital, 39-2nd St. SE, Chesley, ON (GR 926 051). | Chesley and District Hospital, 39-2 nd St. SE, Chesley, ON (GR 926 051). |
| Possible campsite(s) for night. | <ul style="list-style-type: none"> Paisley Rotary Campground (GR 782 059). Saugeen Bluffs Conservation Area, North of Paisley, 1 km west off Bruce Rd 3 (GR 748 109). | Paisley Rotary Campground (GR 782 059). |
| Mode(s) of travel day #2. | <ul style="list-style-type: none"> Mountain bike along the road to Brant Tract Trails (GR 822 982). Mountain bike on Brant Tract Trail system. | Canoe the Saugeen River from Saugeen Access Point #9 (GR 777 073) to Saugeen Access Point #11 (GR 756 083). |
| Mode of travel change point(s) for day #2, if required. | None. | None. |
| Possible lunch locations for day #2. | Brant Tract Trails, 6 km south of Paisley on Concession 12, 1 km east of Bruce Rd 3 (GR 822 982). | <ul style="list-style-type: none"> Hidden Valley Camp, north of Paisley, approximately half way to Saugeen Bluffs (GR 756 083). Saugeen Bluffs Conservation Area (GR 756 083) |

| | Route #1 | Route #2 |
|---|---|---|
| Possible rest-stop / re-supply locations for day #2. | <ul style="list-style-type: none"> • Bruce Rd 19 and Concession 18 (GR 867 024). • Brant Tract Trails (GR 822 982). | <ul style="list-style-type: none"> • Saugeen Access Point # 10, bridge north of Paisley, west side of Bruce Rd 3 (GR 777 073). • Hidden Valley Camp, north of Paisley, approximately half way to Saugeen Bluffs (GR 756 083). |
| Evacuation route(s) for day #2. | Chesley and District Hospital, 39-2 nd St. SE, Chesley, ON (GR 926 051). | Move to nearest road access takeout and then proceed to Chesley and District Hospital, 39-2 nd St. SE, Chesley, ON (GR 926 051). |
| Pick-up point. | Brant Tract Trails, 6 km south of Paisley on Concession 12, 1 km east of Bruce Rd 3 (GR 822 982). | Saugeen Access Point #11, Saugeen Bluffs Conservation Area, North of Paisley, 1 km west off Bruce Rd 3 (GR 748 109). |
| RATING | 2nd Choice | 1st Choice |

PREPARING AN EXPEDITION ROUTE CARD

Route Card - Day 1

| | | | | | |
|--------------------|----------------------|-------------------------------|-----------------|----------------------------|------------------|
| Date: | 5 Oct (Day 1) | Team: | Spartans | Location: | Walkerton |
| Start Time: | 0800 hrs | Estimated Finish Time: | 1700 hrs | Starting Elevation: | 210 m |

| Leg | Mode of Travel | From GR | To GR | Bearing | Distance | Elevation | Time | Route Description |
|------------|-----------------------|----------------|--------------|----------------|-----------------|---|---------------------------|---|
| 1 | Mountain Bike | 748 109 | 767 106 | | 1.3 km | Start (S) - 210 m Finish (F) - 240 m | 6 min | West on Conc. 10 Elderslie until it intersects with Bruce Rd 3. Loose surfaced road. |
| 2 | Mountain Bike | 767 106 | 782 059 | | 5 km | S - 240 m F - 220 m | 15 min (+15 min break) | South on Bruce Rd 3, pass Conc. 8, down big hill, over bridge and into the town of Paisley. Hard packed, main road. Break / water resupply at Paisley Hose Tower. |
| 3 | Mountain Bike | 782 059 | 781 055 | | 500 m | S - 220 m F - 220 m | 2 min | South on Bruce Rd 3, turn west onto Bruce Rd 1 until it is crossed by the Rail Trail. |
| 4 | Mountain Bike | 781 055 | 809 011 | | 5.5 km | S - 220 m F - 250 m | 16 min (+15 min break) | Follow the Rail Trail south until it intersects with Conc. 14 W. There are some hills along the route - mostly flat ground. Rail Trail will cross Bruce Rd 3 after 2 km. Break / water resupply at this point. |
| 5 | Mountain Bike | 809 011 | 812 986 | | 2.6 km | S - 250 m F - 250 m | 8 min | Continue South on the Rail Trail until it intersects with Bruce Rd 3. |
| 6 | Mountain Bike | 812 986 | 814 981 | | 500 m | S - 250 m F - 250 m | 2 min | South on Bruce Rd 3 until it intersects with Conc. 12. Some hills, hard packed, main road. |

| | | | | | | | | |
|----|---------------|---------|---------|--|---------|------------------------|----------------------------|---|
| 7 | Mountain Bike | 814 981 | 822 982 | | 800 m | S- 250 m F - 250 m | 3 min (+1 hour break) | West on Conc. 12 to the entrance to Brant Tract Trails (West Road) parking lot on the north side of the road. Loose surface road. Lunch. |
| 8 | Mountain Bike | 822 982 | | | 11.5 km | various | 60 min | Brant Tract Trail system trails will be run in the following order: Rolling Ferns, The Brainbuster, Devil's Elbow, The Shocker, Buck Run, Razor's Edge, Red Pine Loop and Neeland's Lane. |
| 9 | Mountain Bike | 822 982 | 784 975 | | 3.8 km | S - 250 m F - 260 m | 11 min (+ 15 min break) | West on Conc. 12 to intersection at Baseline Rd N. Will cross Bruce Rd 3, cross Greenock-Brant Townline Rd, go down big hill, cross bridge and causeway. Hard packed, main road. Break/water re-supply. |
| 10 | Mountain Bike | 784 975 | 782 059 | | 9.4 km | S - 260 m F - 220 m | 45 min | South on Baseline Rd N (becomes Bruce Rd1) to the Paisley Rotary Campground. Loose surface road, multiple hills throughout the leg. |

| | |
|-----------------------|--|
| Group Details: | There are six cadets on the team—four male and two female. Three of the six cadets completed Basic Expedition during this past summer. All six cadets have a high level of physical fitness. |
|-----------------------|--|

Route Card - Day 2

| | | | | | |
|--------------------|----------------------|-------------------------------|-----------------|----------------------------|------------------|
| Date: | 6 Oct (Day 2) | Team: | Spartans | Location: | Walkerton |
| Start Time: | 0800 hrs | Estimated Finish Time: | 1500 hrs | Starting Elevation: | 220 m |

| Leg | Mode of Travel | From GR | To GR | Bearing | Distance | Elevation | Time | Route Description |
|-----|----------------|---------|---------|---------|----------|-----------|----------------------------|---|
| 1 | Canoe | 782 059 | 777 073 | | 2.5 km | | 37 min (+ 15 min break) | Break / water resupply at Saugeen Access Point #10 —bridge, river left. |

| | | | | | | | | |
|---|-------|---------|---------|--|--------|--|-------------------------------|---|
| 2 | Canoe | 777 073 | 756 083 | | 2.8 km | | 42 min (+ 15 min break) | Break / water resupply at Hidden Valley Camp, river left. |
| 3 | Canoe | 756 083 | 748 109 | | 3.8 km | | 60 min | Some obstructions along the centre of the river, stay river left. Arrive Saugeen Bluffs Conservation area, river right. |

| | |
|-----------------------|--|
| Group Details: | There are six cadets on the team—four male and two female. Three of the six cadets completed Basic Expedition during this past summer. All six cadets have a high level of physical fitness. |
|-----------------------|--|

CREATE AN EXPEDITION SCHEDULE

| Friday | | |
|----------|---|--|
| Timings | Tasks / Activity | Remarks |
| | Collect Expedition Skill / Experience Assessment Form | Expedition centre staff must read and tabulate scores from Expedition Skills / Experience Assessment form. Place cadets in teams of varied skill levels. |
| | Issue all personal and group expedition equipment | Expedition centre staff. |
| | Set up campsite | Expedition centre staff to rotate to ensure that cadets know how to set up tents, organize equipment, light lanterns, etc. |
| | Initial briefing / divide cadets into teams | To include: activities, expectations, safety, timings, dress, meals, rules, etc. Cadets will be introduced to their team instructor. |
| | Navigation review | Completed as required, time permitting. |
| 2300 hrs | Lights Out | |

| Saturday | | |
|------------------------|-------------------------|---|
| Timings | Tasks / Activity | Remarks |
| 0600 hrs | Reveille / Ablutions | Cadets will pack all personal equipment prior to eating breakfast. |
| 0630 hrs | Breakfast | Supply Officer to prepare breakfast, expedition centre staff to model set-up of eating area, garbage collection, clean up, etc. |
| 0730 hrs | Campsite tear down | Under direction of TI each team will tear down all components of the campsite, organize personal and group equipment for transport to new campsite. |
| 0800 hrs | Start Expedition | Mode of Travel #1—Mountain Bike to Brant Tract Trails - from Brant Tract Trails to Paisley Rotary Campground. |
| 1200 hrs - 1300 hrs | Lunch | Lunch will occur at a Brant Tract Trails parking lot. |
| 1600 hrs | Arrive at camp site # 2 | Teams will set up their campsites, with the TI providing feedback as required. |
| 1730 hrs | Supper | Preparation of supper will be incorporated into the teams campsite set up routine. |
| 2000 hrs | Evening Activities | Cadet will make one entry in their expedition journal. |
| 2200 hrs | Lights out | |

| Sunday | | |
|----------------|---|--|
| Timings | Tasks / Activity | Remarks |
| 0600 hrs | Reveille / Breakfast / Tear down campsite | Teams will be required to complete daily routine activities. |
| 0800 hrs | Continue expedition | Mode of travel #2—Canoe from Paisley to Saugeen Bluffs Conservation Area. |
| 1200 hrs | Lunch | Lunch will occur along the canoe route—teams will be required to bring lunch with them. |
| 1330 hrs | Arrive at Saugeen Bluffs | Teams will complete the de-kitting process under the direction of the expedition centre Log O. |

| | | |
|----------|------------|--|
| 1430 hrs | Debriefing | All cadets will be required to: fill out an expedition centre activity critique and complete a journal entry about their experiences during the weekend. |
| 1500 hrs | Depart | |

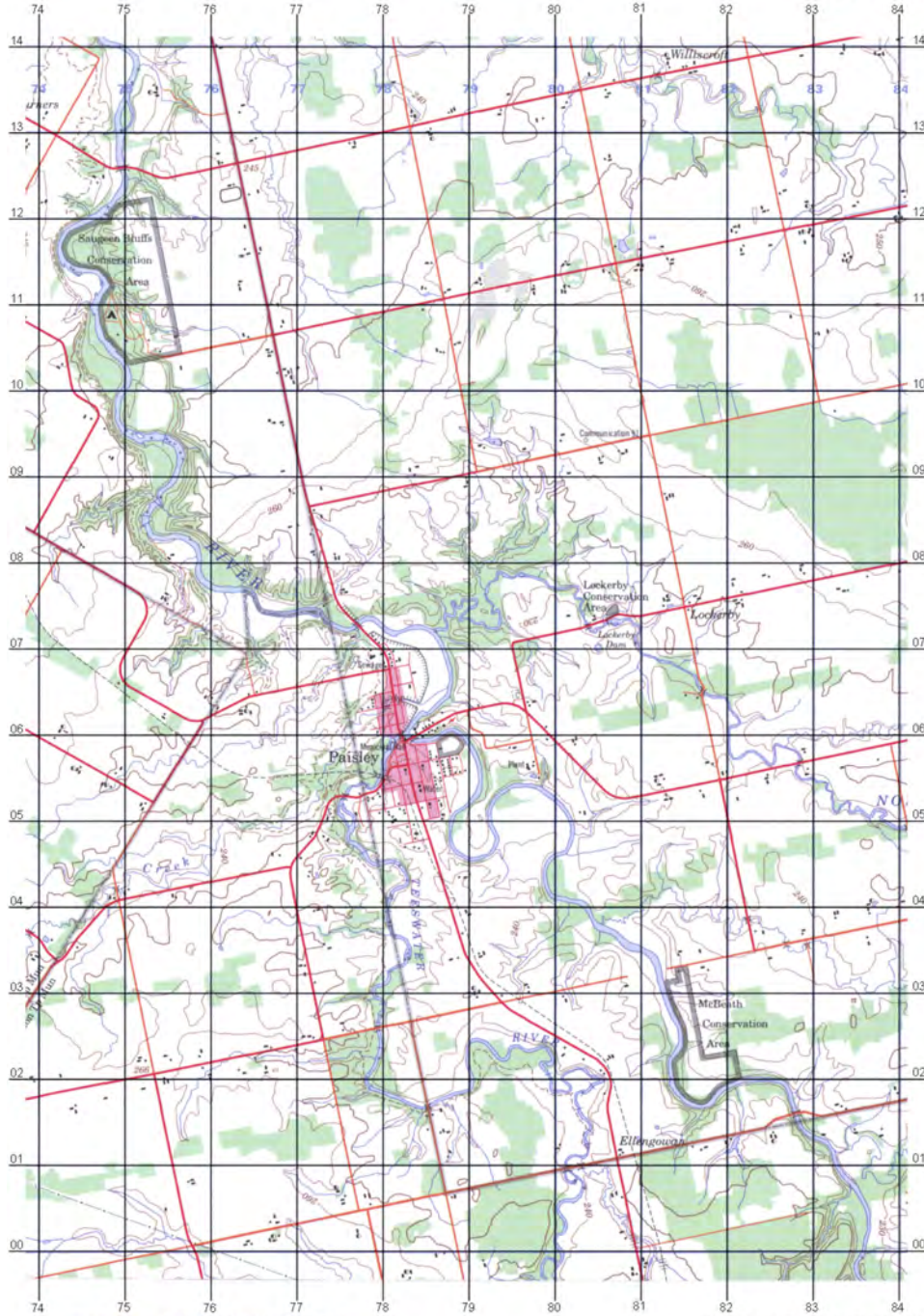
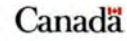

Use diagram only to obtain numerical values
 Approximate Mean Declination 2009
 for centre of map
 Annual change increasing 3.3'

N'utiliser le diagramme que pour obtenir
 les valeurs numériques
 Déclinaison moyenne approximative
 au centre de la carte en 2009
 Variation annuelle croissante 3.3'

CHESLEY

ONTARIO

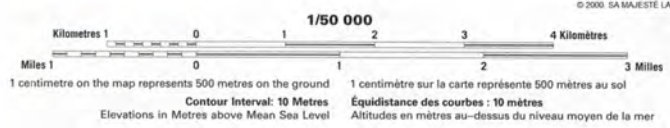

PRODUCED BY THE CENTER FOR TOPOGRAPHIC INFORMATION, NATURAL RESOURCES CANADA
 INFORMATION CURRENT AS OF 1989 ROAD NETWORK, BOUNDARIES AND TOPONYMS CURRENT AS OF 1996. PUBLISHED 2000.

© 2000 HER MAJESTY THE QUEEN IN RIGHT OF CANADA.
 ÉTABLI PAR LE CENTRE D'INFORMATION TOPOGRAPHIQUE, RESSOURCES NATURELLES CANADA. RENSEIGNEMENTS À JOUR EN 1989 RESEAU ROUTIER, LIMITES ET TOPONYMES À JOUR EN 1996. PUBLIÉ EN 2000.

© 2000. SA MAJESTÉ LA REINE DU CHEF DU CANADA.

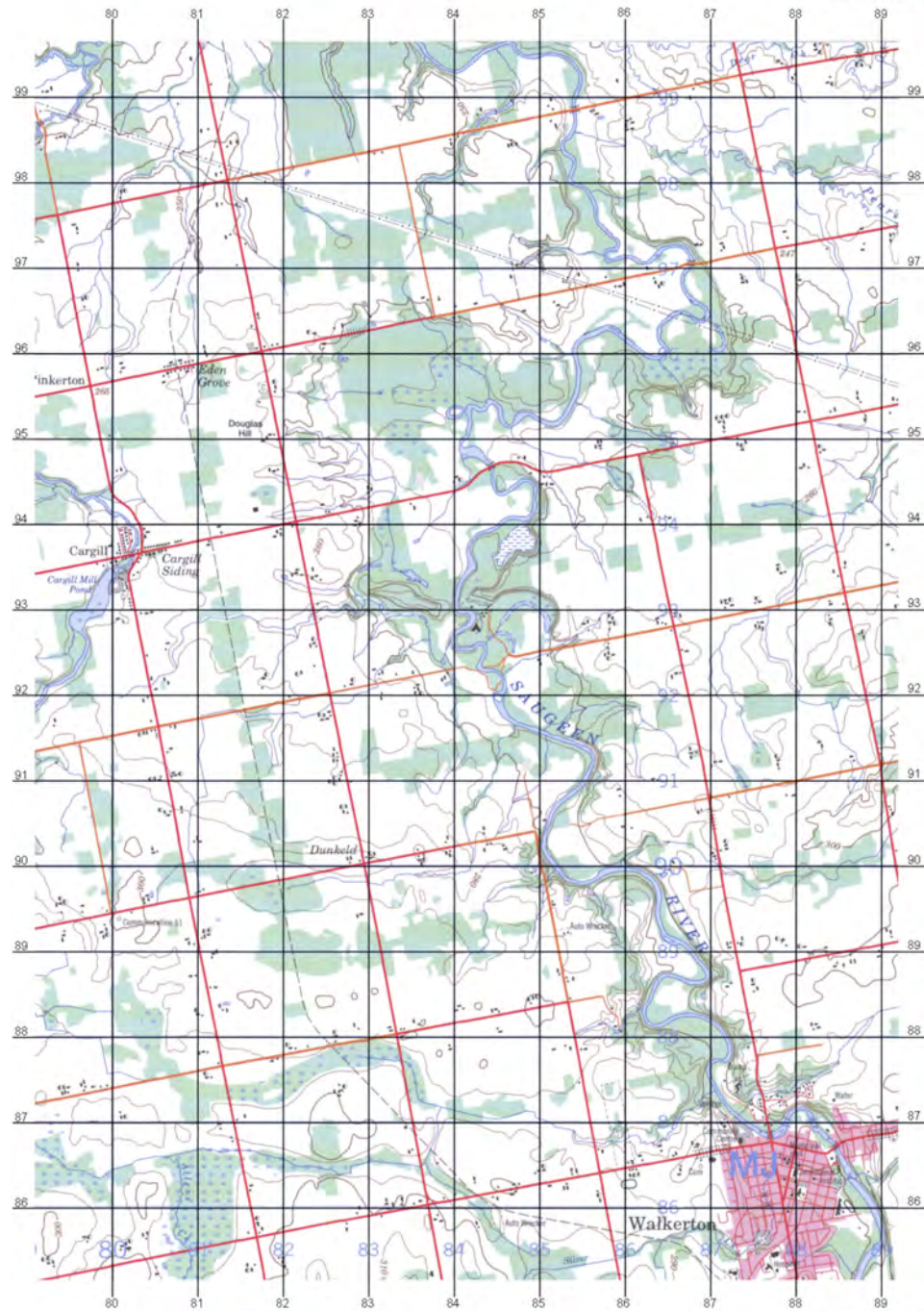
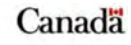

Use diagram only to obtain numerical values
 Approximate Mean Declination 2000
 for centre of map
 Annual change increasing 3.3"

N'utiliser le diagramme que pour obtenir
 les valeurs numériques
 Déclinaison moyenne approximative
 au centre de la carte en 2000
 Variation annuelle croissante 3.3"

WALKERTON

ONTARIO

PRODUCED BY THE CENTER FOR TOPOGRAPHIC
 INFORMATION, NATURAL RESOURCES CANADA,
 INFORMATION COURANT AD OF 1989 ROAD NETWORK,
 BOUNDARIES AND TOPOONY CURRENT AS OF 1996,
 PUBLISHED 2000.

© 2000 HER MAJESTY THE QUEEN IN RIGHT OF CANADA.
 ÉTABLI PAR LE CENTRE D'INFORMATION TOPOGRAPHIQUE,
 RESSOURCES NATURELLES CANADA RENDUEMENTS À
 JOUR EN 1989 RÉSEAU ROUTIER, LIMITES ET TOPONYMES À
 JOUR EN 1996 PUBLIÉE EN 2000.

© 2000 SA MAJESTÉ LA REINE DU CHEF DU CANADA.

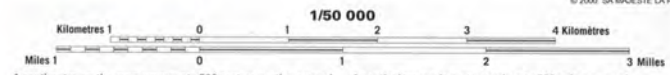

1 centimetre on the map represents 500 metres on the ground
 1 centimètre sur la carte représente 500 mètres au sol

Contour Interval: 10 Metres
 Équidistance des courbes : 10 mètres

Elevations in Metres above Mean Sea Level
 Altitudes en mètres au-dessus du niveau moyen de la mer

THIS PAGE INTENTIONALLY LEFT BLANK



ROYAL CANADIAN ARMY CADETS
GOLD STAR
INSTRUCTIONAL GUIDE



SECTION 3

EO M425.03 – DEVELOP AN EXPEDITION EQUIPMENT LIST

Total Time:

60 min

PREPARATION

PRE-LESSON INSTRUCTIONS

Resources needed for the delivery of this lesson are listed in the lesson specification located in A-CR-CCP-704/PG-001, *Gold Star Qualification Standard and Plan*, Chapter 4. Specific uses for said resources are identified throughout the instructional guide within the TP for which they are required.

Review the lesson content and become familiar with the material prior to delivering the lesson.

Have the cadets bring their Expedition Duo-Tang.

Photocopy Section 3 of the Expedition Planning Booklet located at Attachment A for each group.

Photocopy Section 3 of the Expedition Planning Booklet located at Attachment A for each cadet.

PRE-LESSON ASSIGNMENT

Nil.

APPROACH

An in-class activity was chosen for this lesson as it is an interactive way to provoke thought and stimulate interest about developing expedition equipment lists.

INTRODUCTION

REVIEW

Nil.

OBJECTIVES

By the end of this lesson the cadet shall have developed an expedition equipment list.

IMPORTANCE

It is important for cadets to examine every part of an expedition and consider what equipment and materials are required to successfully complete the desired training. Each activity has unique characteristics, even the same activity at the same location during the same time of year may present equipment differences. Cadets must scrutinize every expedition and ensure all materials and equipment have been determined so orders and requests can be placed and materials prepared prior to the commencement of the expedition.

Teaching Point 1

Have the cadets, in groups of no more than three, develop an expedition equipment list.

Time: 50 min

Method: In-Class Activity

BACKGROUND KNOWLEDGE



Cadets shall be informed of the estimated fuel consumption information below prior to carrying out the activity. This information should be available for all cadets to reference.

FUEL CONSUMPTION

When determining how much fuel to pack for an expedition, refer to the owners' manual of the stove being used to determine how much fuel it will consume. Estimates of fuel consumption for a Coleman Peak One single-burner mountain stove per day are:

Summer

- One person requires 1 / 6 L (5.5 ounces) of fuel.
- A group of three requires 1 / 3 L (11 ounces) of fuel.

Spring / Fall

- One person requires 1 / 4 L (8.5 ounces) of fuel.
- A group of three requires 1 / 2 L (17 ounces) of fuel.

Winter

- One person requires 1 / 2 L (17 ounces) of fuel.
 - A group of three requires 3 / 4 L (25.5 ounces) of fuel.
-

ACTIVITY

Time: 50 min



Cadets will be referencing the guidelines and information developed in their Expedition Duo-Tang.

OBJECTIVE

The objective of this activity is to have the cadets to develop an expedition equipment list, to include:

- personal equipment,
- group equipment, and
- activity-specific equipment.

RESOURCES

- Section 3 of the Expedition Planning Booklet located at Attachment A (one per group),
- Completed example of Section 3 of the Expedition Planning Booklet located at Attachment B,
- Expedition Duo-Tang, and
- Pens / pencils.

ACTIVITY LAYOUT

Set up the classroom for group work, with the required resources, for groups of three cadets.

ACTIVITY INSTRUCTIONS

1. Divide the cadets into groups of no more than three.
2. Distribute Section 3 of the Expedition Planning Booklet to each group.
3. Have each group review Sections 1 and 2 in their Duo-Tang.
4. Based on the information recorded and established in Sections 1 and 2, have the cadets identify the required equipment for the expedition, to include:
 - personal equipment,
 - group equipment, and
 - activity-specific equipment, to include:
 - mountain biking; and
 - canoeing.
5. Tell the groups that they will have five minutes for each list.
6. Circulate among the groups and assist the cadets as necessary, offering suggestions and advice. Refer to the completed example of Section 3 of the Expedition Planning Booklet, as required. Cadets answers may differ depending on the guidelines and route developed.
7. Review the answers with the groups.
8. Distribute Section 3 of the Expedition Planning Booklet to each cadet.
9. Allow 15 minutes for each cadet to record their findings in Section 3 of their Expedition Planning Booklet, using the complied information from the group.
10. Have the cadets place the completed Section 3 of the Expedition Planning Booklet into their Expedition Duo-Tang.

SAFETY

Nil.

CONFIRMATION OF TEACHING POINT 1

The cadets' participation in the activity will serve as the confirmation of this TP.

END OF LESSON CONFIRMATION

The cadets' developing of an expedition equipment list will serve as the confirmation of this lesson.

CONCLUSION

HOMEWORK / READING / PRACTICE

Have the cadets complete any unfinished areas of Section 3 of the Expedition Planning Booklet that could not be completed during the lesson.

METHOD OF EVALUATION

Nil.

CLOSING STATEMENT

A successful expedition relies on many conditions. Taking the time to properly assess the required materials for an expedition helps guarantee a positive expedition experience. Shortages and missing materials place stress on the conducting staff and the quality of training being conducted. A well thought-out expedition leads to a successful expedition.

INSTRUCTOR NOTES / REMARKS

Nil.

REFERENCES

A2-001 A-CR-CCP-951/PT-002 Director Cadets 3. (2006). *Royal Canadian Army Cadets adventure training safety standards*. Ottawa, ON: Department of National Defence.

C2-042 ISBN 0-7566-0946-1 Berger, K. (2005). *Backpacking & hiking*. New York, NY: DK Publishing, Inc.

C2-051 ISBN 978-0-7153-2254-3 Bagshaw, C. (2006). *The ultimate hiking skills manual*. Cincinnati, OH: David & Charles.

SECTION 3 – EXPEDITION EQUIPMENT LIST

PERSONAL EQUIPMENT

Personal expedition equipment are items that are used by an individual and are maintained by that person. Personal equipment is the kit a cadet carries in their expedition field pack.

List all items that cadets are required to bring with them to successfully complete the expedition.

| NON-ISSUED EQUIPMENT SUPPLIED BY CADET | | ISSUED EQUIPMENT UPON ARRIVAL | |
|---|--|--------------------------------------|--|
| 1. | | 1. | |
| 2. | | 2. | |
| 3. | | 3. | |
| 4. | | 4. | |
| 5. | | 5. | |
| 6. | | 6. | |
| 7. | | 7. | |
| 8. | | 8. | |
| 9. | | 9. | |
| 10. | | 10. | |
| 11. | | 11. | |
| 12. | | 12. | |
| 13. | | 13. | |
| 14. | | 14. | |
| 15. | | 15. | |
| 16. | | 16. | |
| 17. | | 17. | |
| 18. | | 18. | |
| 19. | | 19. | |
| 20. | | 20. | |
| 21. | | 21. | |
| 22. | | 22. | |
| 23. | | 23. | |
| 24. | | 24. | |
| 25. | | 25. | |
| 26. | | 26. | |
| 27. | | 27. | |
| 28. | | 28. | |

GROUP EQUIPMENT

Group equipment is selected for its versatility, weight and ease of use. The more compact an item is or can become, the easier it is to pack and carry. Group equipment is given to the cadets upon arrival at the expedition centre.

List all the items the cadets require to successfully complete the expedition. Group equipment includes items that cadets are not expected to purchase, such as two-man tents, water filters and stoves.

ISSUED GROUP EQUIPMENT

Number of persons per group: _____

| | | | |
|-----|--|-----|--|
| 1. | | 27. | |
| 2. | | 28. | |
| 3. | | 29. | |
| 4. | | 30. | |
| 5. | | 31. | |
| 6. | | 32. | |
| 7. | | 33. | |
| 8. | | 34. | |
| 9. | | 35. | |
| 10. | | 36. | |
| 11. | | 37. | |
| 12. | | 38. | |
| 13. | | 39. | |
| 14. | | 40. | |
| 15. | | 41. | |
| 16. | | 42. | |
| 17. | | 43. | |
| 18. | | 44. | |
| 19. | | 45. | |
| 20. | | 46. | |
| 21. | | 47. | |
| 22. | | 48. | |
| 23. | | 49. | |
| 24. | | 50. | |
| 25. | | 51. | |
| 26. | | 52. | |

ACTIVITY—SPECIFIC EQUIPMENT

Record the materials and equipment required to effectively complete the desired training. List all associated equipment and materials that are used for each mode of travel.

MODES OF TRAVEL

| Mode of Travel #1 Equipment Required | |
|---|--|
| Type of Activity: | |
| 1. | |
| 2. | |
| 3. | |
| 4. | |
| 5. | |
| 6. | |
| 7. | |
| 8. | |
| 9. | |
| 10. | |
| 11. | |
| 12. | |
| 13. | |
| 14. | |
| 15. | |
| 16. | |
| 17. | |
| 18. | |
| 19. | |
| 20. | |
| 21. | |
| 22. | |
| 23. | |
| 24. | |
| 25. | |

| Mode of Travel #2 Equipment Required | |
|---|--|
| Type of Activity: | |
| 1. | |
| 2. | |
| 3. | |
| 4. | |
| 5. | |
| 6. | |
| 7. | |
| 8. | |
| 9. | |
| 10. | |
| 11. | |
| 12. | |
| 13. | |
| 14. | |
| 15. | |
| 16. | |
| 17. | |
| 18. | |
| 19. | |
| 20. | |
| 21. | |
| 22. | |
| 23. | |
| 24. | |
| 25. | |

THIS PAGE INTENTIONALLY LEFT BLANK

COMPLETED EXAMPLE OF SECTION 3 OF THE EXPEDITION PLANNING BOOKLET

PERSONAL EQUIPMENT

Personal expedition equipment are items that are used by an individual and are maintained by that person. Personal equipment is the kit a cadet carries in their expedition field pack.

List all items that cadets are required to bring with them to successfully complete the expedition.

| NON-ISSUED EQUIPMENT SUPPLIED BY CADET | |
|---|---|
| 1. | Camera |
| 2. | Camp soap (biodegradable) |
| 3. | Clothing (for 2 days 2 nights) |
| 4. | Facecloth or small towel x 2 |
| 5. | Gloves x 1 pair |
| 6. | High energy snacks |
| 7. | Lip balm |
| 8. | Matches (minimum of 20 strike anywhere) |
| 9. | Notepad and pencil |
| 10. | Pocket knife / survival knife |
| 11. | Rain gear |
| 12. | Sunglasses |
| 13. | Sunscreen—SPF 15, (30 recommended) |
| 14. | Survival kit |
| 15. | Toilet paper x 1 roll |
| 16. | Toothbrush |
| 17. | Toothpaste |
| 18. | Wide brim hat |
| 19. | |
| 20. | |
| 21. | |
| 22. | |
| 23. | |
| 24. | |
| 25. | |
| 26. | |
| 27. | |

| ISSUED EQUIPMENT UPON ARRIVAL | |
|--------------------------------------|---|
| 1. | Backpack (one per cadet) |
| 2. | Carabiner (one per cadet) |
| 3. | Flashlight / headlamp (one per cadet) |
| 4. | Insect repellent (one per cadet) |
| 5. | KFS (knife, fork, spoon,) set (one per cadet) |
| 6. | Plate (one per cadet) |
| 7. | Sleeping bag (one per cadet) |
| 8. | Sleeping mats (one per cadet) |
| 9. | Small bowl (one per cadet) |
| 10. | Trekking pole (one per cadet) |
| 11. | Valise (one per cadet) |
| 12. | Water bottle (one per cadet) |
| 13. | Water carrier (one per cadet) |
| 14. | Whistle (one per cadet) |
| 15. | Mosquito net (one per cadet) |
| 16. | |
| 17. | |
| 18. | |
| 19. | |
| 20. | |
| 21. | |
| 22. | |
| 23. | |
| 24. | |
| 25. | |
| 26. | |
| 27. | |

GROUP EQUIPMENT

Group equipment is selected for its versatility, weight and ease of use. The more compact an item is or can become, the easier it is to pack and carry. Group equipment is given to the cadets upon arrival at the expedition centre.

List all the items the cadets require to successfully complete the expedition. Group equipment includes items that cadets are not expected to purchase, such as two-man tents, water filters and stoves.

ISSUED GROUP EQUIPMENT

Number of persons per group: 9

| | | | |
|-----|--|-----|--|
| 1. | 15-m rope (one per group) | 23. | |
| 2. | Batteries (spares for communication device and GPS) | 24. | |
| 3. | Compass (two per group) | 25. | |
| 4. | First-aid kit (one per group) | 26. | |
| 5. | Food (as detailed in the ration plan) | 27. | |
| 6. | Fuel bottle(s) (three, one litre bottles per group) | 28. | |
| 7. | Garbage bags (one per meal) | 29. | |
| 8. | Glow sticks (two per cadet) | 30. | |
| 9. | GPS receiver (one per group) | 31. | |
| 10. | Hand-held radio (two per group) | 32. | |
| 11. | Naphtha (three litres) | 33. | |
| 12. | Pot set (two sets) | 34. | |
| 13. | Large resealable bags (10 per group) | 35. | |
| 14. | Single burner mountain stove (two per group) | 36. | |
| 15. | Tent complete, 3-person (three per group) | 37. | |
| 16. | Topographical map / guidebook (one per group) | 38. | |
| 17. | Water filter (two per group) | 39. | |
| 18. | | 40. | |
| 19. | | 41. | |
| 20. | | 42. | |
| 21. | | 43. | |
| 22. | | 44. | |
| | | 45. | |
| | | 46. | |
| | | 47. | |

ACTIVITY—SPECIFIC EQUIPMENT ANSWER KEY

Record the materials and equipment required to effectively complete the desired training. List all associated equipment and materials that are used for each mode of travel.

MODES OF TRAVEL

| Mode of Travel #1 Equipment Required | |
|---|--|
| Type of Activity: Canoeing | |
| 1. | Bailer (one per canoe)—22 |
| 2. | Canoes (one per tandem group)—22 |
| 3. | Canoe repair kit (one per canoe group)—4 |
| 4. | Paddles (three per canoe)—66 |
| 5. | Painters (two per canoe)—44 |
| 6. | PFD (one per person)— 44 |
| 7. | Throw Bag with rope, not less than 15 m (49 ft) (one per canoe)—22 |
| 8. | 15-m buoyant heaving line or throw bag (one per canoe)—22 |
| 9. | Wet / dry suits for each person if water conditions are below 10 degrees Celsius—44 |
| 10. | |
| 11. | |
| 12. | |
| 13. | |
| 14. | |
| 15. | |
| 16. | |
| 17. | |
| 18. | |
| 19. | |
| 20. | |
| 21. | |
| 22. | |
| 23. | |

| Mode of Travel #2 Equipment Required | |
|---|---|
| Type of Activity: Mountain Biking | |
| 1. | Basic bike repair kit (one per group)—4 |
| 2. | Helmet (one per person)—44 |
| 3. | Mountain Bike complete (one per person)—44 |
| 4. | Reflective vest (one per group)—4 |
| 5. | |
| 6. | |
| 7. | |
| 8. | |
| 9. | |
| 10. | |
| 11. | |
| 12. | |
| 13. | |
| 14. | |
| 15. | |
| 16. | |
| 17. | |
| 18. | |
| 19. | |
| 20. | |
| 21. | |
| 22. | |
| 23. | |
| 24. | |
| 25. | |

THIS PAGE INTENTIONALLY LEFT BLANK



ROYAL CANADIAN ARMY CADETS
GOLD STAR
INSTRUCTIONAL GUIDE



SECTION 4

EO M425.04 – DEVELOP AN EXPEDITION RATION PLAN

| | |
|-------------|--------|
| Total Time: | 60 min |
|-------------|--------|

PREPARATION

PRE-LESSON INSTRUCTIONS

Resources needed for the delivery of this lesson are listed in the lesson specification located in A-CR-CCP-704/PG-001, *Gold Star Qualification Standard and Plan*, Chapter 4. Specific uses for said resources are identified throughout the instructional guide within the TP for which they are required.

Review the lesson content and become familiar with the material prior to delivering the lesson.

Have the cadets bring their Expedition Duo-Tang.

Photocopy the *Eating Well With Canada's Food Guide* located at Attachment A and the Energy Expenditures for Physical Activity Information Sheet located at Attachment B for each cadet.

Photocopy the Expedition Ration Plan Information Sheet located at Attachment C for each cadet.

Photocopy Section 4 of the Expedition Planning Booklet located at Attachment D for each cadet.

Review the completed example of Section 4 of the Expedition Planning Booklet located at Attachment E.

PRE-LESSON ASSIGNMENT

Nil.

APPROACH

An interactive lecture was chosen for TPs 1–4 as it introduces the cadets to developing an expedition ration plan.

An in-class activity was chosen for TP 5 as it is an interactive way for the cadets to confirm their comprehension of developing an expedition ration plan.

INTRODUCTION

REVIEW

Nil.

OBJECTIVES

By the end of this lesson the cadet shall have developed an expedition ration plan while considering meal requirements, food options, food weight and nutritional value.

IMPORTANCE

It is important for cadets to develop an expedition ration plan as it is a significant step in the process of planning an expedition. Being able to identify the different types of rations, their nutritional values and how the food is going to be packed and cooked, while considering the type of activities that are to be conducted, will aid in the overall success of the expedition. With a successful ration plan, cadets will have more time and energy throughout the day to fully participate in the expedition.

Teaching Point 1**Discuss daily nutrition requirements when on an expedition.**

Time: 10 min

Method: Interactive Lecture



This TP is intended to discuss nutritional requirements when on an expedition.

Distribute *Eating Well With Canada's Food Guide* located at Attachment A and the Energy Expenditures for Physical Activity Information Sheet located at Attachment B for each cadet for reference while describing the nutrition requirements and developing an expedition ration plan.

Basic nutrition must be kept in mind when planning expedition rations, as cadets typically burn many more calories on an expedition compared to most everyday activities. Ensuring an adequate amount of calories and nutritional balance helps to maintain energy levels and positive attitudes, as well-nourished cadets can think better and tend to make better safety-related decisions.

NUTRIENTS

Calories. A measurement of food energy. Required calories are based on the amount and intensity of expedition activities. When an individual's expedition activities change, their eating habits should reflect those changes. More calories are required as activity level increases.

Sodium. Most sodium in food comes from sodium chloride, which is table or sea salt. Salt is a common ingredient in processed and prepared foods. The appropriate amounts of sodium help maintain fluid and electrolytes balance when active.



Water is essential. Even a small amount of dehydration (one percent of body weight) can increase cardiovascular strain as indicated by a disproportionate elevation of heart rate during exercise and limit the ability of the body to transfer heat from contracting muscles to the skin's surface where it can be dissipated to the environment.

Carbohydrates. Primary sources of energy for the body. The types of carbohydrates are fibre, which is a complex carbohydrate, and sugar, which is a simple carbohydrate.

- **Complex carbohydrates.** Break down slowly and can help prevent overeating. They are found in vegetables, fruit, whole grains, brown rice, nuts, soy products and legumes.
- **Fibre.** A complex carbohydrate found in plants. Unlike other carbohydrates it passes through the body undigested and is healthy for the digestive system. Fibre provides energy for the muscles and brain.
- **Simple carbohydrates.** Break down quickly and can cause a person to become hungry quickly (quick high, quick low). They are found in sugary soft drinks, sugary cereals, white bread, white rice, cookies, candy, fries and pastries.
- **Sugars.** A simple carbohydrate. Natural sugars are found in foods such as milk, fruit and vegetables. Added sugars contribute calories, yet they have no significant nutritional value.

Protein. Found in a variety of foods such as meat, poultry, fish, legumes, nuts, milk products and grain products. It builds muscles, bones and teeth.

Vitamin C. Found in many fruits and vegetables. Helps the body fight infections.

Iron. Found in foods such as meat, fish, poultry, grains, vegetables, fruit, nuts and seeds. Helps the red blood cells carry oxygen throughout the body.



The following personal daily nutritional guidelines must be adhered to:

- 50–80 percent should be carbohydrates,
- 10–15 percent should be proteins, and
- 30 percent should be fats (of which only 10 percent should be saturated fats).

CONFIRMATION OF TEACHING POINT 1

QUESTIONS:

- Q1. What are calories and why are they important when planning meals for an expedition?
- Q2. What types of foods are proteins found in?
- Q3. Why is important to include iron when considering nutrition requirements?

ANTICIPATED ANSWERS:

- A1. A measurement of food energy. Required calories are based on the amount and intensity of expedition activities. When an individual's expedition activities change, their eating habits should reflect those changes. More calories are required as activity level increases.
- A2. Proteins are found in a variety of foods such as meat, poultry, fish, legumes, nuts, milk products and grain products.
- A3. Iron helps the red blood cells carry oxygen throughout the body.

Teaching Point 2

Discuss planning meals for an expedition.

Time: 10 min

Method: Interactive Lecture



This TP is intended to consider the people participating in the expedition when planning the meals.

When planning meals for an expedition, considerations need to be determined, such as nutrition, taste, perishability, cooking ease and cleanup. As well, the following aspects of the expedition and mealtimes also need to be determined.

Type of activity. The average individual on an expedition will consume thousands of calories throughout the day, an important factor to remember when planning an expedition ration plan. Depending on the expedition activity, the following calorie consumption is to be considered:

- Activities such as moderate backpacking or canoeing will consume 2 500–3 000 calories per day.
- Strenuous activities such as difficult backpacking or snow camping will consume 3 000–3 500 calories per day.
- Very strenuous activities such as mountaineering or extended periods of time spent in cold weather requires 3 500–5 000 calories per day.

Number of people. For each meal, calculate the amount of cadets on the expedition and the amount of food that will be required for each. Count the total number of meals and categorize them as breakfast, lunch, dinner or snack.



Individuals consume from 1.5–2.5 pounds (.68–1.13 kg) of food per day. When planning meals and meal sizes for the expedition, the following per person, per day estimates are helpful:

- average activities require 1.5 pounds (.68 kg) of food,
- strenuous activities require 1.5–2 pounds (.68 to .91 kg) of food, and
- very strenuous activities require 2–2.5 pounds (.91 to 1.13 kg) of food.

Size of cooking groups. The decision needs to be made whether to cook in small groups or one large group, depending on the number of cadets on the expedition.

- **One large group.** Mealtimes with one large group can promote relaxation and a sense of community. Cooking in a large group ultimately saves weight, as the total number of stoves and pots to carry are minimized, however the actual cooking process tends to take longer to complete.
- **Several small groups.** Mealtimes with small groups tend to be more efficient and it enables more people to become more proficient cooks. Small groups can create a sense of separation unless cooking groups are rotated frequently.



Group leaders need to decide whether to cook and eat with the groups or alone. On a short trip or with young cadets, it makes sense for the leader to share food with the group. On a long trip or with more experienced cadets, it can be very productive for the group(s) if the leaders separate themselves. It gives cadets complete control of the quality and timings of the meals and a sense of independence.

Special meal requirements. When deciding what to eat at each meal, it is important to take note of food preferences (eg, vegetarians) and allergies within the group.

Helpful Tips

The following are helpful tips for when planning the rations and conducting mealtimes on an expedition:

- **Plan ahead.** While dinner is cooking, plan the food for the next day. Sort the food required for the next day while on the trail in one or two stuff sacks. Try to plan simple meals for long days and more complex meals on the easier days.
- **Eat often.** While conducting expedition activities, try to consume calories more efficiently by eating five times a day (breakfast, morning snack, lunch, afternoon snack and dinner).
- **Pack individual snack bags.** Rather than having one large bag of trail mix, divide the large bag into individual snack bags the night before. This way, each person can snack throughout the day according to individual needs, rather than waiting for a group-determined snack break. It also limits the spreading of germs.
- **Keep snacks accessible.** Pack lunch and snacks in the top or side pockets of the expedition field pack for easy access.
- **Start slow-cooking food early.** Pre-soak foods that may take a long time to cook (eg, beans).

- **Oil the pot.** Prior to cooking starches or grains, rub the inside of the pot with margarine or oil. This makes cleanup easier and prevents liquids from boiling over.
- **Be creative with leftovers.** Think of ways to use leftovers (eg, leftover rice can be kneaded into bread dough, fried up with spices, or made into rice pudding by adding milk, sugar, raisins and nutmeg or cinnamon). Screw-top hard-plastic containers are useful for storing leftovers for later consumption.
- **Make hot drinks for more than one.** When making hot drinks, make a full pot for several cadets.
- **Drink, drink, drink.** Water helps digest food.
- **Use dried fruits and vegetables.** Rehydrated dried fruits and vegetables can make a bland meal seem almost gourmet.

CONFIRMATION OF TEACHING POINT 2

QUESTIONS:

- Q1. How many calories are consumed when conducting very strenuous activities?
- Q2. How many pounds of food do cadets consume per day, on average?
- Q3. What are the advantages to cooking as a large group?

ANTICIPATED ANSWERS:

- A1. Very strenuous activities require 3 500–5 000 calories per day.
- A2. Cadets consume from 1.5–2.5 pounds of food per day.
- A3. Mealtimes with one large group promotes relaxation and a sense of community. Cooking in a large group ultimately saves weight, as the total number of stoves and pots to carry are minimized.

Teaching Point 3

Discuss the types and options of expedition rations.

Time: 10 min

Method: Interactive Lecture



This TP is intended to introduce the types and options when planning expedition rations.

Distribute the Expedition Ration Plan Information Sheet located at Attachment C for each cadet for reference while describing the types and options of expedition rations and developing an expedition ration plan.

EXPEDITION RATION TYPES

Whether conducting a menu plan or bulk rations for the expedition, there are five food types to consider when developing an expedition ration plan.

1. **Freeze-dried.** A way to preserve food by freezing it and drying it by the sublimation of ice in a vacuum. Pre-packaged freeze-dried meals are very light to carry and allow for quick preparation with minimal cooking skills and time, however they tend to be more expensive (average \$4–10 per meal) and tend to be less nutritious. There are many types of food that can be freeze-dried (eg, meat, pasta and vegetables).



Pre-packaged meals that are made for four people may actually only satisfy two very hungry people. Supplementing with additional rice or noodles may be required.

2. **Dehydrated.** Food that has had the water removed for preservation and storage (eg, fruit, vegetables and meat).
3. **Trail food.** Food that can be consumed while in the middle of an activity (eg, trail mix and granola bars).
4. **Fresh rations.** Food that has been store bought and is still fresh for consumption (eg, fruit, vegetables and meat).
5. **Individual meal packages (IMPs) and meals ready to eat (MREs).** Otherwise known as boil-in-the-bag. Each IMP and MRE include a main course (meat or vegetarian), vegetables and fruit in sealed foil pouches, and dried foods in paper/tinfoil pouches. All of the food items are safe to eat cold and dry—they may not taste as good as hot food, though. High sugar items like chocolate, hard candies and drink mixes, as well as coffee and tea are also included.

These types of meals were developed to meet a typical day's three meal requirement. These meals are identified as breakfast, lunch and supper and contain between 1400 and 1800 calories—enough calories for an adult performing strenuous tasks for prolonged periods.



Staple food is the chief element or a main component of a meal (eg, rice or noodles).

EXPEDITION RATION OPTIONS

Being able to develop an appropriate expedition ration plan is an important aspect of expedition planning, as the food consumed can dramatically affect the success of an expedition. There are two different expedition rationing options that are commonly followed when designing a ration plan.

Menu Planning



Ask the cadets questions about planning a menu to evaluate their level of knowledge.

Some sample questions may include:

- Have you planned meals for an expedition before?
- What factors did you have to consider when planning meals for an expedition?
- What type of meals did you plan for the expedition?

Menu planning systematically plans the contents of each meal over the course of the expedition. The advantages to menu planning are that there is an organized guide of each meal created to assist in preparation and it is a convenient way to plan for short expeditions (2–5 days).

Steps of the Menu Planning System

The menu planning system has seven steps:

1. Determine the number of meals (breakfast, lunch, dinner and snacks) that are required for the expedition.
2. Identify items which can be eaten at each meal.

3. Decide specifically what to eat at each of the meals, taking note of food preferences and allergies within the group.



When deciding each meal, some helpful hints may include:

- packing fresh foods (fruits and vegetables) for the first day or two;
- freezing meat that will be thawed and ready to cook for dinner; and
- adding freeze-dried items which can add additional nutrition (eg, freeze-dried peas added into a pasta dish).

4. Estimate how much food will be needed at each meal to feed every cadet, while considering:
 - a. how big the appetites will be,
 - b. how strenuous the expedition will be, and
 - c. the time of year.
5. Determine the total food required, based on the menu and generate a shopping list.
6. Purchase the food.
7. Repackage, prepare and pack the food for the expedition.

Bulk Rationing

Buy food in bulk based on the amount and weight of food consumed per day. The advantages to bulk rationing are that it provides opportunities for cooking creativity, allows easier calculations for caloric and nutritional levels and is more beneficial for longer trips. The bulk ration system tends to be more financially feasible, as cadets can eat plenty of delicious food for \$3–6 a day.

Bulk food must be repacked into clear plastic bags or containers to reduce packaging and additional waste in the field. There are many foods that can be purchased in bulk to repackage for the expedition such as pasta, beans, rice, flour, cereals, nuts, dried fruits, sugar, soup bases and spices.

CONFIRMATION OF TEACHING POINT 3

QUESTIONS:

- Q1. What are the five types of expedition rations?
- Q2. What are the two different expedition rationing options that are commonly followed when designing a ration plan?
- Q3. What is the average cost per person, per day with the bulk ration system?

ANTICIPATED ANSWERS:

- A1. The five types of expedition rations are:
 - freeze-dried,
 - dehydrated,
 - trail food,

- fresh rations, and
- IMPs.

A2. The two different expedition rationing options are menu planning and bulk rations.

A3. The bulk ration system tends to be more financially feasible, as cadets can eat plenty of delicious food for \$3–6 a day.

Teaching Point 4

Discuss packing food for an expedition.

Time: 5 min

Method: Interactive Lecture



This TP is intended to discuss packing and distributing food prior to conducting an expedition.

Have examples of containers, pre-assembled meals and packed food for the cadets to view.

Once the expedition ration plan has been developed and the food has been purchased, the food must be pre-assembled and packed. The following steps simplify packaging, carrying and preparing food while on the expedition.

Strip away the packaging. Cardboard, paper, foil and cans are all excess weight and potential litter.

Select containers. Pack food in see-through bags and containers to allow the contents to be easily seen and selected without having to open the bag or container. Labelling or marking the bags or containers can also aid in selecting. Use bags or containers that are lightweight and are resealable. Examples of containers that can be used include:

- resealable plastic bags (or other strong bags that can be tied),
- resealable plastic containers,
- plastic bottles with screw-top lid, and
- squeeze tubes.



When labelling each container or bag, meal directions or ingredients can also be marked on the outside (eg, pasta directions or chili ingredients).

Pre-assemble the meals. Pre-assembling most of the food prior to the expedition saves time and aids by having the meal preparation times go faster and smoother. Some examples of pre-assembling meals include:

- throwing all ingredients in a bag (called meal-in-a-bag) and cook when required;
- pre-soaking foods that require a longer time to cook (eg, beans); and
- dividing trail food into individual bags.

Develop storage for cold items. As some meals require foods to be chilled or frozen throughout the expedition, cold storage will need to be developed for those items. It is recommended that frozen or chilled items be used first to ensure they stay fresh. If this is not possible, a cold storage system needs to be developed. As groups are rarely stationary on an expedition, maintaining cold storage may be difficult, however some locations to store cold foods may include:

- ice packs and coolers,
- food barrels,
- in a river, lake or creek (ensure the container is sealed),
- in the snow, and
- with regular or dry ice (be careful when handling dry ice).

Divide items among group members. As repackaging consolidates food into a more manageable system of transport, it is easier to distribute the food among the group. When the food has been labelled, it is then distributed among group members. Keep the contents of one complete meal together with one person, as this allows for each meal to be found easily among the group.

CONFIRMATION OF TEACHING POINT 4

QUESTIONS:

- Q1. What are some examples of containers that may be used to pack and store food while on an expedition?
- Q2. Why is it beneficial to pre-assemble most of the food prior to the expedition?
- Q3. What are some locations that food can be stored in order to stay cold?

ANTICIPATED ANSWERS:

- A1. Some examples of containers that can be used to pack and store food while on an expedition include:
- resealable plastic bags (or other strong bags that can be tied),
 - resealable plastic containers,
 - plastic bottles with screw-top lid, and
 - squeeze tubes.
- A2. Pre-assembling most of the food prior to the expedition saves time and aids in having the meal preparation time go faster and smoother.
- A3. Some locations to store cold foods include:
- ice packs and coolers,
 - food barrels,
 - in a river, lake or creek (ensure the container is sealed),
 - in the snow, and
 - with regular or dry ice (be careful when handling dry ice).

Teaching Point 5**Have the cadets, in groups of no more than three, develop an expedition ration plan.**

Time: 15 min

Method: In-Class Activity

ACTIVITY**OBJECTIVE**

The objective of this activity is to have the cadets, in groups of no more than three, develop an expedition ration plan and record the information in the Expedition Planning Booklet.

RESOURCES

- *Eating Well With Canada's Food Guide* located at Attachment A (one per cadet),
- Energy Expenditures for Physical Activity Information Sheet located at Attachment B (one per cadet), and
- Expedition Ration Plan Information Sheet located at Attachment C (one per cadet),
- Section 4 of the Expedition Planning Booklet located at Attachment D (one per cadet),
- Completed example of Section 4 of the Expedition Planning Booklet located at Attachment E,
- Expedition Duo-Tang, and
- Pens / pencils.

ACTIVITY LAYOUT

Nil.

ACTIVITY INSTRUCTIONS

1. Divide the cadets into groups of no more than three.
2. Distribute to each cadet:
 - a. Section 4 of the Expedition Planning Booklet, and
 - b. Expedition Ration Plan Information Sheet.
3. Introduce the expedition ration guidelines, to include:
 - a. meal requirements based on activity,
 - b. food options,
 - c. food weights,
 - d. nutritional value, and
 - e. packing and food distribution.
4. Have the groups read through the Expedition Ration Plan Information Sheet.
5. Have the groups fill in the expedition ration information in Section 4 of the Expedition Planning Booklet using information gathered from the Expedition Ration Plan Information Sheet.

6. Have the groups share their answers. Refer to the completed example of Section 4 of the Expedition Planning Booklet as required.

SAFETY

Nil.

CONFIRMATION OF TEACHING POINT 5

The cadet's participation in the activity will serve as the confirmation of this TP.

END OF LESSON CONFIRMATION

QUESTIONS:

- Q1. What foods are vitamin C found in and why is vitamin C important to the body?
- Q2. After determining whether to have large or small cooking groups, what other factors need to be considered when deciding how or where to eat as the leader?
- Q3. What are the seven steps when conducting the menu planning system on an expedition?

ANTICIPATED ANSWERS:

- A1. Vitamin C is found in many fruits and vegetables and helps the body fight infections.
 - A2. Group leaders need to decide whether to cook and eat with the groups or alone. On a short trip or with young cadets, it makes sense for the leader to share food with the group. On a long trip or with more advanced cadets, it can be very productive for the group(s) if the leader(s) separate themselves. It gives cadets complete control of the quality and timings of the meals and a sense of independence.
 - A3. The seven steps when conducting the menu planning system are:
 1. Determine the number of meals (breakfast, lunch, dinner and snacks) that are required for the expedition.
 2. Identify items which can be eaten at each meal.
 3. Decide specifically what to eat at each of the meals.
 4. Estimate how much food will be needed at each meal to feed every cadet.
 5. Determine the total food required, based on the menu and generate a shopping list.
 6. Go shopping for the food.
 7. Repackage, prepare and pack the food for the expedition.
-

CONCLUSION

HOMEWORK / READING / PRACTICE

Nil.

METHOD OF EVALUATION

This lesson is assessed IAW A-CR-CCP-704/PG-001, *Gold Star Qualification Standard and Plan*, Chapter 3, Annex B, 425 PC.

CLOSING STATEMENT

A well thought out ration plan can provide the required nutrients and energy levels required to successfully complete the expedition and achieve the goals and objectives that have been set out. As the ration plan is being developed it is also important to consider the types of activities, cadets and how the food is going to be packed and cooked. Creating a ration plan is a skill that can be applied when planning other overnight activities.

INSTRUCTOR NOTES / REMARKS

Nil.

REFERENCES

C2-034 ISBN 0-87322-637-2 Priest, S., & Gass, M. (2005). *Effective leadership in adventure programming* (2nd ed.). Windsor, ON: Human Kinetics Publishing Inc.

C2-153 ISBN 0-7360-5731-5 Martin, B., Cashel, C., Wagstaff, M., & Breunig, M. (2006). *Outdoor leadership: Theory and practice*. Windsor, ON: Human Kinetics.

C2-208 ISBN 978-1-59485-033-2 Raynolds, J., Lodato, A., Gordon, R., Blair-Smith, C., Welsh, J., & Gerzon, M. (2007). *Leadership the outward bound way*. Seattle, WA: The Mountaineers Books.

C2-251 ISBN 978-0-8117-3464-6 Pearson, C., & Kuntz, J. (Eds.) (2008). *NOLS backcountry cooking: Creative menu planning for short trips*. Mechanicsburg, PA: Stackpole Books.

THIS PAGE INTENTIONALLY LEFT BLANK



Health
Canada

Santé
Canada

Your health and
safety... our priority.

Votre santé et votre
sécurité... notre priorité.

Eating Well with Canada's Food Guide

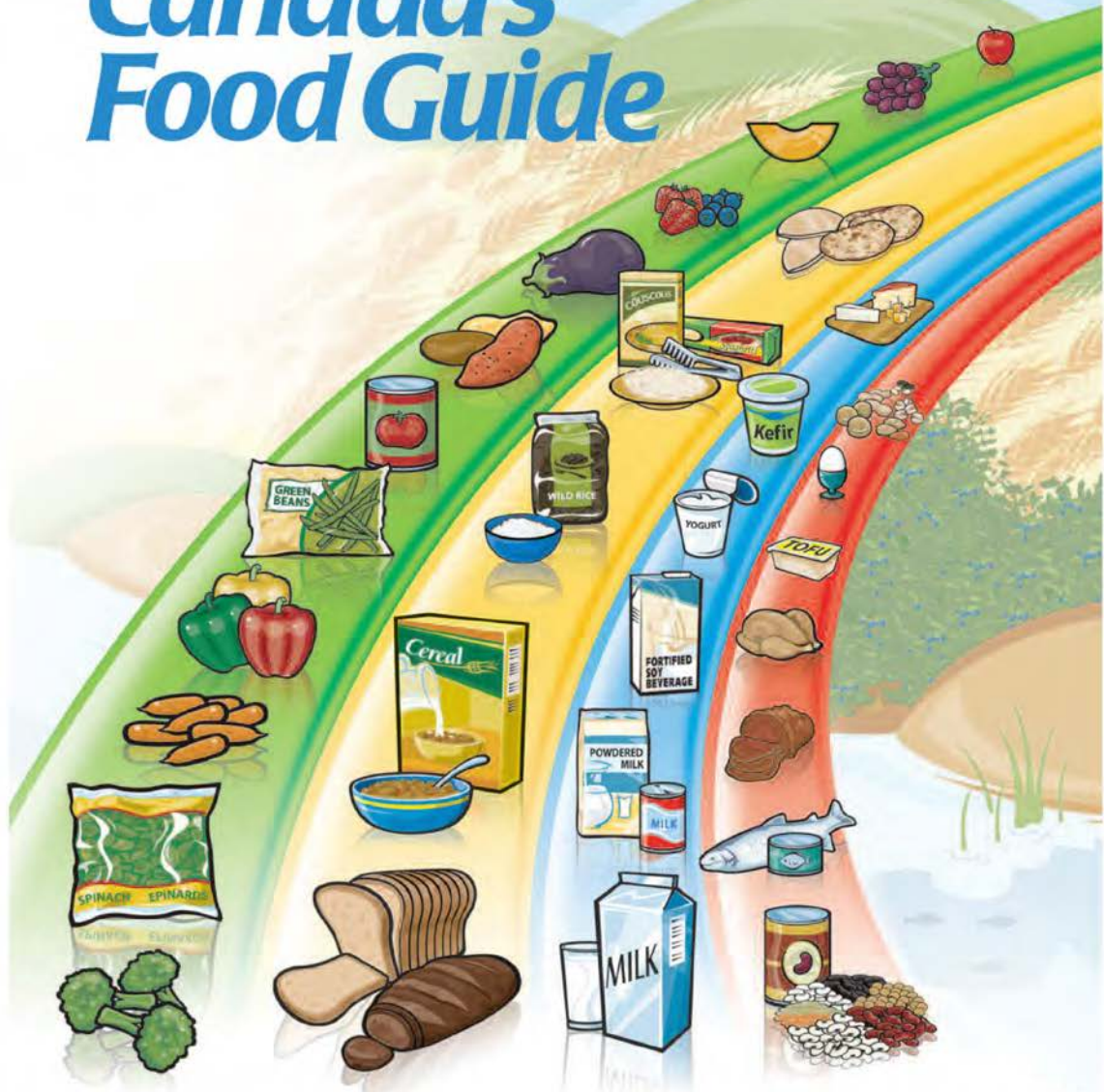

Canada

Recommended Number of Food Guide Servings per Day

| Age in Years Sex | Children | | | Teens | | Adults | | | |
|------------------------------|----------------|-----|------|---------|-------|---------|-------|---------|-------|
| | 2-3 | 4-8 | 9-13 | 14-18 | | 19-50 | | 51+ | |
| | Girls and Boys | | | Females | Males | Females | Males | Females | Males |
| Vegetables and Fruit | 4 | 5 | 6 | 7 | 8 | 7-8 | 8-10 | 7 | 7 |
| Grain Products | 3 | 4 | 6 | 6 | 7 | 6-7 | 8 | 6 | 7 |
| Milk and Alternatives | 2 | 2 | 3-4 | 3-4 | 3-4 | 2 | 2 | 3 | 3 |
| Meat and Alternatives | 1 | 1 | 1-2 | 2 | 3 | 2 | 3 | 2 | 3 |

The chart above shows how many Food Guide Servings you need from each of the four food groups every day.

Having the amount and type of food recommended and following the tips in *Canada's Food Guide* will help:

- Meet your needs for vitamins, minerals and other nutrients.
- Reduce your risk of obesity, type 2 diabetes, heart disease, certain types of cancer and osteoporosis.
- Contribute to your overall health and vitality.

What is One Food Guide Serving?
 Look at the examples below.

| | | | | | | | | | | | |
|--|--|---|--|---|--|--|--|---|--|---|--|
|  <p>Fresh, frozen or canned vegetables 125 mL (½ cup)</p> | |  <p>Leafy vegetables Cooked: 125 mL (½ cup) Raw: 250 mL (1 cup)</p> | |  <p>Fresh, frozen or canned fruits 1 fruit or 125 mL (½ cup)</p> | |  <p>100% Juice 125 mL (½ cup)</p> | | | | | |
|  <p>Bread 1 slice (35 g)</p> | |  <p>Bagel ½ bagel (45 g)</p> | |  <p>Flat breads ½ pita or ½ tortilla (35 g)</p> | |  <p>Cooked rice, bulgur or quinoa 125 mL (½ cup)</p> | |  <p>Cereal Cold: 30 g Hot: 175 mL (¾ cup)</p> | |  <p>Cooked pasta or couscous 125 mL (½ cup)</p> | |
|  <p>Milk or powdered milk (reconstituted) 250 mL (1 cup)</p> | |  <p>Canned milk (evaporated) 125 mL (½ cup)</p> | |  <p>Fortified soy beverage 250 mL (1 cup)</p> | |  <p>Yogurt 175 g (¾ cup)</p> | |  <p>Kefir 175 g (¾ cup)</p> | |  <p>Cheese 50 g (1 ½ oz.)</p> | |
|  <p>Cooked fish, shellfish, poultry, lean meat 75 g (2 ½ oz.)/125 mL (½ cup)</p> | |  <p>Cooked legumes 175 mL (¾ cup)</p> | |  <p>Tofu 150 g or 175 mL (¾ cup)</p> | |  <p>Eggs 2 eggs</p> | |  <p>Peanut or nut butters 30 mL (2 Tbsp)</p> | |  <p>Shelled nuts and seeds 60 mL (¼ cup)</p> | |



Oils and Fats

- Include a small amount – 30 to 45 mL (2 to 3 Tbsp) – of unsaturated fat each day. This includes oil used for cooking, salad dressings, margarine and mayonnaise.
- Use vegetable oils such as canola, olive and soybean.
- Choose soft margarines that are low in saturated and trans fats.
- Limit butter, hard margarine, lard and shortening.



Make each Food Guide Serving count...
wherever you are – at home, at school, at work or when eating out!

▶ **Eat at least one dark green and one orange vegetable each day.**

- Go for dark green vegetables such as broccoli, romaine lettuce and spinach.
- Go for orange vegetables such as carrots, sweet potatoes and winter squash.

▶ **Choose vegetables and fruit prepared with little or no added fat, sugar or salt.**

- Enjoy vegetables steamed, baked or stir-fried instead of deep-fried.

▶ **Have vegetables and fruit more often than juice.**

▶ **Make at least half of your grain products whole grain each day.**

- Eat a variety of whole grains such as barley, brown rice, oats, quinoa and wild rice.
- Enjoy whole grain breads, oatmeal or whole wheat pasta.

▶ **Choose grain products that are lower in fat, sugar or salt.**

- Compare the Nutrition Facts table on labels to make wise choices.
- Enjoy the true taste of grain products. When adding sauces or spreads, use small amounts.

▶ **Drink skim, 1%, or 2% milk each day.**

- Have 500 mL (2 cups) of milk every day for adequate vitamin D.
- Drink fortified soy beverages if you do not drink milk.

▶ **Select lower fat milk alternatives.**

- Compare the Nutrition Facts table on yogurts or cheeses to make wise choices.

▶ **Have meat alternatives such as beans, lentils and tofu often.**

▶ **Eat at least two Food Guide Servings of fish each week.***

- Choose fish such as char, herring, mackerel, salmon, sardines and trout.

▶ **Select lean meat and alternatives prepared with little or no added fat or salt.**

- Trim the visible fat from meats. Remove the skin on poultry.
- Use cooking methods such as roasting, baking or poaching that require little or no added fat.
- If you eat luncheon meats, sausages or prepackaged meats, choose those lower in salt (sodium) and fat.



* Health Canada provides advice for limiting exposure to mercury from certain types of fish. Refer to www.healthcanada.gc.ca for the latest information.

Advice for different ages and stages...

Children

Following *Canada's Food Guide* helps children grow and thrive.

Young children have small appetites and need calories for growth and development.

- Serve small nutritious meals and snacks each day.
- Do not restrict nutritious foods because of their fat content. Offer a variety of foods from the four food groups.
- Most of all... be a good role model.



Women of childbearing age

All women who could become pregnant and those who are pregnant or breastfeeding need a multivitamin containing **foliac acid** every day. Pregnant women need to ensure that their multivitamin also contains **iron**. A health care professional can help you find the multivitamin that's right for you.

Pregnant and breastfeeding women need more calories. Include an extra 2 to 3 Food Guide Servings each day.

Here are two examples:

- Have fruit and yogurt for a snack, or
- Have an extra slice of toast at breakfast and an extra glass of milk at supper.



Men and women over 50

The need for **vitamin D** increases after the age of 50.

In addition to following *Canada's Food Guide*, everyone over the age of 50 should take a daily vitamin D supplement of 10 µg (400 IU).



How do I count Food Guide Servings in a meal?

Here is an example:

Vegetable and beef stir-fry with rice, a glass of milk and an apple for dessert



| | | |
|--|---|--|
| 250 mL (1 cup) mixed broccoli, carrot and sweet red pepper | = | 2 Vegetables and Fruit Food Guide Servings |
| 75 g (2 1/2 oz.) lean beef | = | 1 Meat and Alternatives Food Guide Serving |
| 250 mL (1 cup) brown rice | = | 2 Grain Products Food Guide Servings |
| 5 mL (1 tsp) canola oil | = | part of your Oils and Fats intake for the day |
| 250 mL (1 cup) 1% milk | = | 1 Milk and Alternatives Food Guide Serving |
| 1 apple | = | 1 Vegetables and Fruit Food Guide Serving |

Eat well and be active today and every day!

The benefits of eating well and being active include:

- Better overall health.
- Lower risk of disease.
- A healthy body weight.
- Feeling and looking better.
- More energy.
- Stronger muscles and bones.

Be active

To be active every day is a step towards better health and a healthy body weight.

Canada's Physical Activity Guide recommends building 30 to 60 minutes of moderate physical activity into daily life for adults and at least 90 minutes a day for children and youth. You don't have to do it all at once. Add it up in periods of at least 10 minutes at a time for adults and five minutes at a time for children and youth.

Start slowly and build up.



Eat well

Another important step towards better health and a healthy body weight is to follow Canada's Food Guide by:

- Eating the recommended amount and type of food each day.
- Limiting foods and beverages high in calories, fat, sugar or salt (sodium) such as cakes and pastries, chocolate and candies, cookies and granola bars, doughnuts and muffins, ice cream and frozen desserts, french fries, potato chips, nachos and other salty snacks, alcohol, fruit flavoured drinks, soft drinks, sports and energy drinks, and sweetened hot or cold drinks.

Read the label

- Compare the Nutrition Facts table on food labels to choose products that contain less fat, saturated fat, trans fat, sugar and sodium.
- Keep in mind that the calories and nutrients listed are for the amount of food found at the top of the Nutrition Facts table.

Nutrition Facts

Per 0 mL (0 g)

| Amount | % Daily Value |
|-------------------------|---------------|
| Calories 0 | |
| Fat 0 g | 0 % |
| Saturates 0 g | 0 % |
| + Trans 0 g | |
| Cholesterol 0 mg | |
| Sodium 0 mg | 0 % |
| Carbohydrate 0 g | 0 % |
| Fibre 0 g | 0 % |
| Sugars 0 g | |
| Protein 0 g | |
| Vitamin A 0 % | Vitamin C 0 % |
| Calcium 0 % | Iron 0 % |

Limit trans fat

When a Nutrition Facts table is not available, ask for nutrition information to choose foods lower in trans and saturated fats.

Take a step today...

- ✓ Have breakfast every day. It may help control your hunger later in the day.
- ✓ Walk wherever you can – get off the bus early, use the stairs.
- ✓ Benefit from eating vegetables and fruit at all meals and as snacks.
- ✓ Spend less time being inactive such as watching TV or playing computer games.
- ✓ Request nutrition information about menu items when eating out to help you make healthier choices.
- ✓ Enjoy eating with family and friends!
- ✓ Take time to eat and savour every bite!

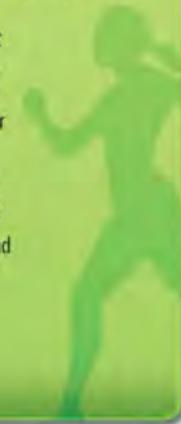

For more information, interactive tools, or additional copies visit Canada's Food Guide on-line at: www.healthcanada.gc.ca/foodguide

or contact:

Publications
 Health Canada
 Ottawa, Ontario K1A 0K9
 E-Mail: publications@hc-sc.gc.ca
 Tel.: 1-866-225-0709
 Fax: (613) 941-5366
 TTY: 1-800-267-1245

Également disponible en français sous le titre :
 Bien manger avec le Guide alimentaire canadien

This publication can be made available on request on diskette, large print, audio-cassette and braille.

ENERGY EXPENDITURES FOR PHYSICAL ACTIVITY INFORMATION SHEET

Many references evaluate the amount of calories burnt during various activities. This table is to serve as a guide with the understanding that other resources could suggest different values. Values below are for activities of one-hour durations.

| Activity (1 hour) | Cadet Weight | | |
|---|--------------|---------|---------|
| | 130 lbs | 155 lbs | 190 lbs |
| Backpacking, general | 413 | 493 | 604 |
| Bicycling, < 16 km / h, leisure | 236 | 281 | 345 |
| Bicycling, > 32 km / h, racing | 944 | 1126 | 1380 |
| Bicycling, 16–19 km / h, light effort | 354 | 422 | 518 |
| Bicycling, 19–22.4 km /h, moderate effort | 472 | 563 | 690 |
| Bicycling, 22.4–25.4 km / h, vigorous effort | 590 | 704 | 863 |
| Bicycling, 25.4–30.4 km / h, very fast, racing | 708 | 844 | 1035 |
| Canoeing, on camping trip | 236 | 281 | 345 |
| Canoeing, rowing, > 9.6 km / h, vigorous effort | 708 | 844 | 1035 |
| Canoeing, rowing, light effort | 177 | 211 | 259 |
| Canoeing, rowing, moderate effort | 413 | 493 | 604 |
| Cooking or food preparation | 148 | 176 | 216 |
| Hiking, cross country | 354 | 422 | 518 |
| Skiing, cross-country, moderate effort | 472 | 563 | 690 |
| Skiing, cross-country, slow or light effort | 413 | 493 | 604 |
| Skiing, cross-country, uphill, maximum effort | 974 | 1161 | 1423 |
| Skiing, cross-country, vigorous effort | 531 | 633 | 776 |
| Snowshoeing | 472 | 563 | 690 |
| Walking, 3.2 km / h, slow pace | 148 | 176 | 216 |
| Walking, 5.6 km / h, uphill | 354 | 422 | 518 |
| Walking, 6.4 km / h, very brisk pace | 236 | 281 | 345 |
| White-water rafting, kayaking, or canoeing | 295 | 352 | 431 |

THIS PAGE INTENTIONALLY LEFT BLANK

EXPEDITION RATION PLAN INFORMATION SHEET

Steps of the Menu Planning System

1. Determine the number of meals (breakfast, lunch, dinner and snacks) that are required for the expedition.
2. Identify items which can be eaten at each meal.
3. Decide specifically what to eat at each of the meals.
4. Estimate how much food will be needed at each meal to feed every cadet.
5. Determine the total food required, based on the menu and generate a shopping list.
6. Purchase the food.
7. Repackage, prepare and pack the food for the expedition.

Number of Calories per Pound for Some Expedition Ration Items

| DAIRY | GRAINS / STARCHES | LEGUMES | MEATS | TRAIL FOODS | SWEETS | CONDIMENTS | DRINKS | SPICES | MISC. |
|-----------------------|----------------------|------------------|------------------|-----------------------|-----------------------|---------------------|---------------------|--------------------|---------------------|
| Powdered Milk: 1650 | Flour (white): 1650 | Lentils: 150 | Bacon Bits: 2836 | Dried Apricots: 1100 | Honey: 1300 | Jelly: 1200 | Tea: 0 | Salt and Pepper: 0 | Yeast: 0 |
| Powdered Eggs: 2700 | Flour (wheat): 1500 | Pinto Beans: 200 | Pepperoni: 2250 | Mix Dried Fruit: 1250 | White Sugar: 1700 | Peanut Butter: 2580 | Coffee: 0 | Garlic Powder: 0 | Olive Oil: 4000 |
| Margarine: 1900 | Pancake Mix: 1850 | Chili Base: 1600 | Salami: 2050 | Raisins: 1400 | Brown Sugar: 1700 | Maple Syrup: 1222 | Hot Cocoa Mix: 1650 | Oregano: 0 | Vegetable Oil: 4000 |
| Cheddar Cheese: 1760 | Pasta Noodles: 1700 | Soup Mix: 2000 | | Salted Peanuts: 2650 | Chocolate Chips: 2100 | Salad Dressing: 500 | Juice Mix: 1950 | Chili Powder: 0 | Granola Bars: 1760 |
| Parmesan Cheese: 1800 | Rice (white): 1650 | | | Roasted Peanuts: 2500 | Cocoa: 1650 | Soy Sauce: 240 | | Onion Powder: 0 | Popcorn: 1650 |
| Dairy Cream: 3750 | Rolled Oats: 1750 | | | Cashews: 2500 | Cookies: 2200 | Bbq Sauce: 240 | | Curry Powder: 0 | Ketchup: 400 |
| | Cream of Wheat: 1750 | | | Walnuts: 2450 | Brownie Mix: 1800 | | | Beef Bouillon: 0 | Tomato Sauce: 109 |
| | Potato: 1624 | | | M&M's: 2133 | | | | Tabasco: 0 | |

| | |
|---|--|
| <p>Core Nutrients</p> <ul style="list-style-type: none"> • calories, • sodium, • carbohydrates, to include: <ul style="list-style-type: none"> ○ complex carbohydrates, ○ fibre, ○ simple carbohydrates, and ○ sugars. • proteins, • vitamin C, and • iron. | <p>Nutritional Needs Required per Cadet per Day</p> <ul style="list-style-type: none"> • 50 percent to 80 percent carbohydrates, • 10 percent to 15 percent proteins, and • 30 percent fats (of which only 10 percent should be saturated fats). |
| | <p>Types of Expedition Activities</p> <ul style="list-style-type: none"> • Activities such as moderate backpacking or canoeing will require 2 500–3 000 calories per day. • Strenuous activities such as difficult backpacking or snow camping will require 3 000–3 500 calories per day. • Very strenuous activities such as mountaineering or extended time spent in cold weather requires 3 500–5 000 calories per day. |
| | <p>Average Consumption per Day</p> <ul style="list-style-type: none"> • From 1.5–2.5 pounds (.68–1.13 kg) of food. • Average activities require 1.5 pounds (.68 kg) of food. • Strenuous activities require 1.5–2 pounds (.68–.91 kg) of food. • Very strenuous activities require 2–2.5 pounds (.91–1.13 kg) of food. |

Helpful Tips When Planning Expedition Rations and Conducting Mealtimes

- Plan ahead.
- Eat often.
- Pack individual snack bags.
- Keep snacks accessible.
- Start slow-cooking food early.
- Oil the pot.
- Be creative with leftovers.
- Make hot drinks for more than one cadet.
- Drink, drink, drink.
- Use dried fruits and vegetables.

| SAMPLE MENU PLAN | Friday | Saturday | Sunday |
|-------------------------|--|--|--|
| Breakfast | | Hash browns with cheese Powdered Milk Hot coffee / chocolate | Oatmeal Powdered Milk Salami Hot coffee / chocolate |
| Morning snack | | GORP | Granola bars |
| Lunch / Dinner | | Salami Bagels Havarti cheese Fruit drink | Veggie wrap Carrots Soup Fruit drink |
| Afternoon snack | | Peanut butter Crackers | |
| Dinner / Supper | Instant soup Basic pasta Fruit bars Hot chocolate | Chili No-bake cookies Fruit Hot Chocolate | |

THIS PAGE INTENTIONALLY LEFT BLANK

SECTION 4 – EXPEDITION RATION PLAN

IDENTIFY THE ACTIVITIES BEING CONDUCTED ON THE EXPEDITION

1: Identify expedition ration planning guidelines.

| | |
|--------------------------------------|--|
| Time of Year / Number of Days | |
| Number of Cadets | |

2: Determine number of meals required.

| | Day One | Day Two | Day Three | Total |
|------------------------|----------------|----------------|------------------|--------------|
| Breakfast | | | | |
| Morning Snack | | | | |
| Lunch / Dinner | | | | |
| Afternoon Snack | | | | |
| Dinner / Supper | | | | |

3: Determine the following.

| | |
|---|--|
| What type of meals may be prepared and eaten on this type of expedition. | |
| Determine how much food is required. | |
| Special meal requirements. | |
| Cooking group size(s). | |
| Packing food considerations. (packaging, pre-assembling meals and food and weight distribution) | |
| Budget (if applicable). | |

4: Create a menu plan.

| | Day One | Day Two | Day Three |
|------------------------|----------------|----------------|------------------|
| Breakfast | | | |
| Morning Snack | | | |
| Lunch / Dinner | | | |
| Afternoon Snack | | | |
| Dinner / Supper | | | |

THIS PAGE INTENTIONALLY LEFT BLANK

COMPLETED EXAMPLE OF SECTION 4 OF THE EXPEDITION PLANNING BOOKLET
IDENTIFY THE ACTIVITIES BEING CONDUCTED ON THE EXPEDITION

Canoeing on flatwater. Paddling a distance between 10–15 km.

Mountain biking on familiarization trails. Biking a distance between 40–50 km.

1: Identify expedition ration planning guidelines.

| | |
|--------------------------------------|--|
| Time of Year / Number of Days | Fall (October) / 2 nights, 3 days. |
| Number of Cadets | 36 cadets (12 females, 24 males), 8 staff (5 male, 3 female) = 44 total cadets |

2: Determine number of meals required.

| | Day One | Day Two | Day Three | Total |
|------------------------|----------------|----------------|------------------|--------------|
| Breakfast | | 44 | 44 | 88 |
| Morning Snack | | 44 | 44 | 88 |
| Lunch / Dinner | | 44 | 44 | 88 |
| Afternoon Snack | | 44 | | 44 |
| Dinner / Supper | 44 | 44 | | 88 |

3: Determine the following.

| | |
|--|---|
| <p>What type of meals may be prepared and eaten on this type of expedition.</p> | <p>A menu that includes some fresh rations, with some meals to be pre-assembled prior to the expedition. Breakfast Saturday morning and Supper / Dinner Saturday evening will be the two pre-assembled meals. The remaining meals and snacks will be fresh rations.</p> |
| <p>Determine how much food is required.</p> | <p>44 cadets—six meals and three snacks each. 264 meals and 132 snacks total. (note the total weight of food and caloric requirements)</p> |
| <p>Special meal requirements.</p> | <p>One vegetarian.</p> |
| <p>Cooking group size(s).</p> | <p>Six groups with each group consisting of six cadets and one staff. Two remaining staff will be cooking / eating on their own.</p> |
| <p>Packing food considerations. (packaging, pre-assembling meals and food and weight distribution)</p> | <p>Two meals will be pre-assembled prior to expedition. Remaining meals will be fresh rations stored in containers. Each cadet will carry one full meal and their individual snacks.</p> |
| <p>Budget (if applicable).</p> | <p>Not applicable.</p> |

4: Create a menu plan.

| | Day One | Day Two | Day Three |
|------------------------|---|---|--|
| Breakfast | | Pancakes Fruit Powdered milk Hot coffee / chocolate | Fried cheese bagels Salami Fruit drink Hot coffee / chocolate |
| Morning Snack | | No-bake cookies | Peanut butter Crackers |
| Lunch / Dinner | | Italian pasta salad Fruit bars Cheese Fruit drink | Basic falafel Vegetables No-bake cookies Powdered milk |
| Afternoon Snack | | Trail Mix | |
| Dinner / Supper | Sweet and sour rice Vegetables Crackers Hot coffee / chocolate | Vegetarian meatballs Soup Fruit Hot coffee / chocolate | |

THIS PAGE INTENTIONALLY LEFT BLANK



ROYAL CANADIAN ARMY CADETS

GOLD STAR

INSTRUCTIONAL GUIDE



SECTION 5

EO C425.01 – DISCUSS ACTIONS TAKEN WHEN A PERSON IS LOST

Total Time:

60 min

PREPARATION

PRE-LESSON INSTRUCTIONS

Resources needed for the delivery of this lesson are listed in the lesson specification located in A-CR-CCP-704/PG-001, *Gold Star Qualification Standard and Plan*, Chapter 4. Specific uses for said resources are identified throughout the instructional guide within the TP for which they are required.

Review the lesson content and become familiar with the material prior to delivering the lesson.

Refer to local area instructions as well as the corps / regional standard operating procedure (SOP) for information on when to contact emergency services after a person is missing or lost, for use in TP 5.

PRE-LESSON ASSIGNMENT

Nil.

APPROACH

An interactive lecture was chosen for TPs 1–4 and TP 6 as it introduces the cadets to precautions to take, lost person behaviour, ways to communicate with a lost person and common search and rescue techniques.

A group discussion was chosen for TP 5 as it allows the cadets to interact with their peers and share their knowledge and opinions about when to contact emergency services when lost. Sharing in the discussion encourages the cadets to examine their own thoughts and feelings and may prompt them to re-examine their previously held ideas. Participating in a group discussion improves the cadets' listening skills and team development.

INTRODUCTION

REVIEW

Nil.

OBJECTIVES

By the end of this lesson the cadet shall have discussed actions taken when a person is lost.

IMPORTANCE

It is important for cadets to know what actions to take when lost as well as the actions searchers will take to find them. When completing cadet activities in the field, the possibility of becoming lost is always present. When planning and leading activities, it is important to understand and communicate search and rescue principles. Cadets participating in an activity should be aware of the actions they must take when lost, as it will increase the chances of them being found quickly.

Teaching Point 1**Discuss lost person behaviour.**

Time: 10 min

Method: Interactive Lecture

LOST PERSON BEHAVIOUR

Every lost person will react differently. The behaviours listed are generalizations of lost persons.



It is possible that some cadets have been lost before (eg, in a big department store, driving to an unfamiliar destination with their parents, out for a walk). Have the cadets share their experiences.



Have the cadets briefly answer the following questions:

- If you became lost, how would you react?
- Do you think you could control fear and panic?
- Would you be prepared to analyze the situation and establish a logical course of action?

Understanding / predicting the behaviour of a lost or missing person can greatly increase the chances for a successful search.

Initial Actions

A person who has received some survival training will know that the first step when becoming lost is to STOP (stop, think, observe and plan) and then gather information in order to try to determine current location. Someone who has not been trained may begin to panic when they realize that they are lost.

Movement Patterns

If a lost person finds a trail, they will most likely start hiking on it. It is more likely they will follow a route of easy travel than one more advanced. A lost person will rarely reverse direction on a trail. They may hike to higher elevation, hoping to see more of the area.



The person may convince themselves that they are making their way back to the group, when in fact they are heading in the opposite direction.

Behaviour Patterns

Behaviour will differ from one person to the next, from situation to situation.



Have the cadets imagine they have become lost. Ask them if they think their behaviour would be different in the daytime than in the night-time? Why?

Day behaviour. Throughout the day, a lost person will most likely attempt to be found by wandering to look for people or wait for searchers to locate them. When a person keeps themselves busy, feelings of fear and panic will be minimized.

Night behaviour. A lost person may become scared and lonely in the night and seek temporary shelter. They will usually stay in the same place throughout the night. If capable, they will try to ignite a fire (which may also act as a signal).

Panic behaviour. Panic often causes a person to act without thinking. When a lost person panics, they become disoriented and wander aimlessly, possibly becoming hysterical.

Behaviour when a person does not want to be found. A person who does not want to be found likely became lost to gain attention or for fear of punishment. They are most likely seeking solitude and will not respond to searchers' efforts and will do very little to aid in their rescue.

CONFIRMATION OF TEACHING POINT 1

QUESTIONS:

- Q1. What are some typical movement patterns of a lost person?
- Q2. If a person is lost and finds a trail, what will they likely do?
- Q3. Why would a person not want to be found?

ANTICIPATED ANSWERS:

- A1. If a lost person finds a trail, they will most likely start hiking on it. They are also much more likely to follow a route of easy travel than one more advanced. A lost person will rarely reverse direction on a trail. A lost person may hike to a high elevation, hoping to see more of the area.
- A2. They will most likely start hiking on it.
- A3. A person who does not want to be found likely became lost to gain attention or for fear of punishment.

Teaching Point 2

Explain precautions that will minimize the possibility of a person becoming lost.

Time: 10 min

Method: Interactive Lecture



This lesson concentrates on becoming lost as an individual. Stress that the same principles apply when a group of cadets become lost.



There is a possibility of becoming lost at all times when in the field, even when going to the washroom or filling up a canteen. It is good practice to carry a whistle at all times and have a general idea of the layout of the land.

PRECAUTIONS THAT WILL MINIMIZE THE POSSIBILITY OF A PERSON BECOMING LOST



All of the precautions listed below should be included during the initial briefing of an activity.

Provide Clear and Detailed Instructions on the Activity Being Completed

When briefing the cadets on the activity to be completed, ensure the instructions are clear and detailed. All cadets should know the what, where, why, when and how prior to the start of the activity.

Everyone involved in the activity should have a clear understanding of the route and the route plan. During the initial briefing, make sure everyone looks at their map and follows along the route as it is identified and described. This way, the cadets can visualize where they are going as well as see the features along the route, such as hills, rivers, trails and other conventional signs.

Set Activity Boundaries

Objects such as pole lines, fences, and rivers make great boundaries. Have all of the cadets look at the map and outline the boundaries along the route. When the cadets participating in the activity have clearly-defined and well-understood boundaries, the chances of becoming lost are minimized. If a person does become lost, they will likely be found quicker, by staying within the boundaries.

Provide All Personnel With a Safety Bearing

A safety bearing, when set on a compass, leads a person to a major feature such as a road, fence or landmark. It is designed to assist a person who is lost or separated from the group to find a location where they can then be located. A safety bearing should be derived for every cadet activity involving hiking / navigation / expedition-type activities. It can be set on the compass and walked on until the feature is reached. It is also good to provide a general direction to travel (eg, hike north-west until a road is reached)

Enforce a "Buddy System" at All Times

Using the buddy system will help reduce the possibility of a person becoming lost, because they will never be alone. The buddy system should be enforced throughout all weekend training activities, even at night when a person has to use the washroom.



Becoming disoriented by going to the washroom in the dark could result in becoming lost.

Provide All Personnel With Noise-Making Devices

A series of three anything (eg, whistle blasts, flashes) is the universal signal for distress. Each cadet should have devices that can be used to signal when training in the field. Noise-making devices can be whistles, horns or even yells.

CONFIRMATION OF TEACHING POINT 2

QUESTIONS:

- Q1. Why is it important to set activity boundaries?
- Q2. What is a safety bearing?
- Q3. What is the universal sign for distress?

ANTICIPATED ANSWERS:

- A1. When the cadets participating in the activity have clearly-defined and well-understood boundaries, the chances of becoming lost are minimized. If a person does become lost, they will likely be found quicker (if they stay within the boundaries).
- A2. A safety bearing, when set on a compass, leads a person to a major feature such as a road, fence or landmark. It is designed as a way to assist a person who is lost or separated from the group to find a location where they can wait to be found.
- A3. A series of three anything (eg, whistle blasts, flashes).

Teaching Point 3

Explain immediate actions to take when one becomes lost or separated from the group.

Time: 5 min

Method: Interactive Lecture

Each survival situation must be analyzed and dealt with according to the circumstances. In addition to being proficient in survival skills, individuals should also know something about the area they may be required to survive in—the climate, flora, fauna, escape routes, search and rescue procedures, etc. The mind is the most essential component for survival. Being prepared means being able to cope with the seven enemies of survival, while still being able to make good decisions.

IMMEDIATE ACTIONS TO TAKE WHEN ONE BECOMES LOST OR SEPARATED FROM THE GROUP

Employ the STOP Procedure

Once it is determined that one is lost, the best thing to do is to stay in one place, keep calm and try to gather information to determine one's location. It is extremely important to concentrate on making good decisions.

STOP is a mnemonic for:

- **Sit.** Stop where you are! Do not panic. Many lost people waste valuable energy and risk injury by panicking—running aimlessly, continuing to travel after dark, or walking in circles. If a lost person decides to immediately wander in an attempt to find their location, in most cases they will move further away and increase the distance between the known points of their course. This will only increase the size of the search area, increasing the time it will take for a rescue team to locate an individual. As long as there is no immediate danger, stay in one place. During the first 30 minutes of being lost is when people tend to make their biggest mistakes. Making good decisions about the situation involves thinking through options without panicking.
- **Think.** Think about immediate and future dangers and the factors involved in the situation. Consider the time of day, personal physical condition and the last time water or food was consumed. Try to list the options that are available.

- **Observe.** Observe and listen for the signals of rescuers. Study the immediate environment, determining weather, terrain and resources available. Check the immediate area for a shelter location, fresh drinking water, and for clues of the current location.
- **Plan.** Plan the best course of action. It could be close to dark and consideration should be given to setting up shelter, finding water or starting a fire. A safety bearing could have been provided prior to beginning the activity and consideration should be given to use it or not. Include how to signal rescuers in the plan.

Listen for a Whistle Signal / Yell / Horn Honking From the Group / Searchers

When the group becomes aware that a person is missing or lost, one of the first steps is to make noise, that the missing person may hear.

Communicate the Location to the Group / Searchers by Making Noise

As a missing person, it is important to make noise that the group / searchers may hear so that they can approach the general area. Blowing a whistle or banging objects together to make noise will save the voice.

Walk on the Safety Bearing to the Nearest Road or Fence Line

After employing the STOP procedure and listening for and communicating with noise, the next step is to walk on the safety bearing provided in the briefing. The safety bearing should help a missing person become located by leading them to a major feature such as a road, fence or landmark. Once the feature has been reached, the person should stop, remain in their position and wait to be found.

CONFIRMATION OF TEACHING POINT 3

QUESTIONS:

- Q1. What is the first action to take when lost?
- Q2. What should one think about when employing the STOP procedure?
- Q3. Why should a lost person make noise?

ANTICIPATED ANSWERS:

- A1. Employ the STOP procedure.
- A2. Think about immediate and future dangers and the factors involved in the situation. Consider the time of day, personal physical condition, and the last time water or food was consumed. Try to list the options that are available.
- A3. It is important to make noise that the group / searchers may hear so that they can approach the general area.

Teaching Point 4**Explain actions the group / searchers will take when a person becomes lost.**

Time: 15 min

Method: Interactive Lecture



The actions listed below are the first steps a group will take when it is confirmed that a person has become lost.

The leader of the group will begin to complete these actions without search and rescue personnel. These actions will help make the decision about when to call search and rescue personnel to be dispatched to the area.

If search and rescue professionals are dispatched, they will require this information.

ACTIONS THE GROUP / SEARCHERS WILL TAKE WHEN A PERSON BECOMES LOST

When it is discovered that a person is missing, the first instinct may be to go in the direction they were last seen, shouting their name. If everyone in the group has the same instinct, the list of missing persons may soon include the entire group.

Panic is triggered when a person becomes lost; however, it is a time when people need to remain calm, think clearly and act deliberately.

Analyze the Severity of the Situation

A combination of factors affecting urgency will help determine not only how quickly to respond, but the nature and level of response. A decision whether or not to contact emergency services will have to be made. The first step is to analyze the severity of the situation. If the majority of these factors are a high level of concern, it is likely that the leader should contact emergency services.

Time of day. A person lost in the evening is more of a concern than in the morning. Searching is more likely to be successful during daylight.

Weather. Severe weather (eg, torrential rain, snow, cold, fog) lessens the chances of a person being found. The forecasted weather should be considered. Searching is more likely to be successful in good weather.

Age and experience level of the person. A person with limited navigation and survival training will be more concerning than a person who has completed a variety of survival training.

Medical concerns. When a missing person has a medical concern or injury, their condition must be carefully analyzed. Will they need medication soon? How long can they go without medication? Will they need medical attention when found?



People with serious medical issues could behave abnormally.

Equipment in the person's possession. When a person has limited equipment, the necessity to begin a search becomes more important. When participating in an activity, it is important that cadets have equipment such as a signalling device, water and rain gear (if the forecast is calling for rain). Knowing what the person is wearing will help the search process, since personnel know what colour(s) to look for.



When conducting activities, it is a good idea to give every cadet a garbage bag. The garbage bag can act as raingear, a water collection device, temporary shelter and a signalling device, yet it is small enough to fit in the cadet's pocket.

Signalling devices available. When a missing person has a signalling device, such as a whistle, a horn, matches or a flashlight, the group can be made aware of the sounds and sights to look for. The leader should also complete an inventory of the signalling devices available that the group can use to signal the lost person.

Communicate With the Lost Person

There are a variety of ways in which the group should try to communicate with the lost person.

Make noise. When a lost person hears noise, they will likely move toward it. Also, hope of being found will begin to rise, since they are now aware that people are looking for them close by.

Mark trees. A lost person may wander around the area. If they see a marking on a tree left by the group, they will know that people are near. When marking trees, the group could also leave instructions stating what the person should do.

Use signalling devices. There are a variety of signalling devices that the group could use, such as a signal fire, flares, a whistle, and a horn. If the lost person sees a signal, they will know which direction to head toward.

Confine the Area to Establish a Search Perimeter



Confinement area. A search perimeter that encompasses the last known area of the missing person and beyond. Once the area has been established, it should be unlikely that the missing person could pass through it without being detected.

Road blocks / trail blocks / patrols. Roads or pathways provide routes in which the missing person could depart. Road blocks / trail blocks / patrols leading in and out of the confinement area should be established. It is possible that the missing person could find a car passing by and simply hop in it and get transported to the closest town (while people are still searching). Also, personnel in the area can be made aware of the situation and provide searchers with any known information.

Lookouts. Searchers find locations at high elevations and look for the missing person.

Track traps. Areas in which tracks easily appear (eg, dusty road, sandy area, and mud) and are brushed off so that there are no tracks or marks. These areas are then checked frequently for tracks. If tracks are found in a track trap, searchers know that the missing person has moved through the area.

String lines. As searchers make their way through the perimeter of an area, one person carries a spool of string. As they walk through an area, the string unrolls, leaving a visible trail. The string then serves as a perimeter to confine the missing person, as well as a sign that assistance is nearby.

CONFIRMATION OF TEACHING POINT 4

QUESTIONS:

- Q1. What are the factors considered to analyze the severity of the situation when a person becomes lost?
- Q2. What is a confinement area?
- Q3. What are some ways to confine the area to establish a search perimeter?

ANTICIPATED ANSWERS:

A1. The factors used to analyze the severity of the situation are:

- the time of day,
- the weather,
- the age and experience level of the person,
- medical concerns,
- equipment in the person's possession, and
- signalling devices available.

A2. A confinement area is a search perimeter that encompasses the last known area of the missing person and beyond. Once the area has been established, it should be unlikely that the missing person could pass through it without being detected.

A3. A search perimeter can be established by using:

- road blocks / trail blocks / patrols,
- lookouts,
- track traps, and
- string lines.

Teaching Point 5

Discuss when to contact emergency services.

Time: 5 min

Method: Group Discussion

BACKGROUND KNOWLEDGE



The point of the group discussion is to draw the following information from the group using the tips for answering / facilitating discussion and the suggested questions provided.

WHEN TO CONTACT EMERGENCY SERVICES

There are no hard and fast rules that state when emergency services should be contacted after a person becomes lost. It is the responsibility of the leader to make the call based on the following factors:

- time of day,
- current and forecasted weather,
- age and experience level of the cadet,
- medical concerns,

- equipment in the cadet's possession, and
- signalling devices available.

If there is any doubt whether or not the cadet will be found, there is little light left in the day or the temperatures are dropping, it is recommended that emergency services be contacted.

It typically takes emergency services a minimum of one hour to initiate a search and rescue mission once they have been notified and even longer for rural areas without teams stationed in the area. Also, emergency services will usually not begin a search after dark—they will wait until first light.



It is much easier to call off emergency personnel than call them in.

GROUP DISCUSSION



TIPS FOR ANSWERING / FACILITATING DISCUSSION:

- Establish ground rules for discussion, eg, everyone should listen respectfully; don't interrupt; only one person speaks at a time; no one's ideas should be made fun of; you can disagree with ideas but not with the person; try to understand others as much as you hope they understand you; etc.
- Sit the group in a circle, making sure all cadets can be seen by everyone else.
- Ask questions that will provoke thought; in other words avoid questions with yes or no answers.
- Manage time by ensuring the cadets stay on topic.
- Listen and respond in a way that indicates you have heard and understood the cadet. This can be done by paraphrasing their ideas.
- Give the cadets time to respond to your questions.
- Ensure every cadet has an opportunity to participate. One option is to go around the group and have each cadet answer the question with a short answer. Cadets must also have the option to pass if they wish.
- Additional questions should be prepared ahead of time.

SUGGESTED QUESTIONS:

- Q1. What local area instructions and corps / regional SOP for when to contact emergency services exist in your area?
- Q2. What factors would influence the decision whether or not to contact emergency services?
- Q3. Approximately how long do you think it would take emergency services to get to your local area and begin a search mission?



Other questions and answers will develop throughout the group discussion. The group discussion should not be limited to only those suggested.



Reinforce those answers given and comments made during the group discussion, ensuring the teaching point has been covered.

CONFIRMATION OF TEACHING POINT 5

The cadets' participation in the group discussion will serve as the confirmation of this TP.

Teaching Point 6

Discuss ground search procedures used by search and rescue professionals when dispatched.

Time: 5 min

Method: Interactive Lecture



There are a wide variety of documented search and rescue procedures. These procedures will be completed by search and rescue professionals, once they have been dispatched to the area.

GROUND SEARCH PROCEDURES USED BY SEARCH AND RECUE PROFESSIONALS WHEN DISPATCHED

Hasty Search

A hasty search does not have definable boundaries. This type of search is used to discover evidence / the missing person quickly by visiting general locations where they are likely to be found (eg, campsites, abandoned vehicles, roads, trails). Hasty search techniques are usually used in the early stages of a search, but can be used anytime to check an unconfirmed sighting or to recheck specific, likely locations.

The goal of a hasty search is speed. The team is normally comprised of two to four searchers.



Running a trail, path or track is an example of a hasty search.



Other terms used to describe hasty searches include scratch, eyeball, quick-look, 360s, sign-cutting, ridge running, road / trail patrolling and trail running.

Loose Grid Search

This search involves searchers lining up on a baseline, at a wide spacing. Spacing is dependent on terrain and visibility. Generally, the amount of overlapping area should be minimal; however, searchers should always be able to maintain occasional visual / voice contact with the searchers on either side.

Once the search lanes are established, each searcher proceeds to search their area by weaving / roaming forward.

The loose grid search is generally used in the early stages of a search operation, especially if hasty searches found clues and the time frame is short. They may also be valuable in situations where the search area is large and the area has not been confined.

The goal of a loose grid search is to cover a large geographic area quickly, with few resources. The team is normally comprised of three to seven searchers.



Other terms used to describe loose grid searches include open grid and low coverage searches.



For Figures 1–3:

- A = the visual scan width, and
- B = the sweep width.

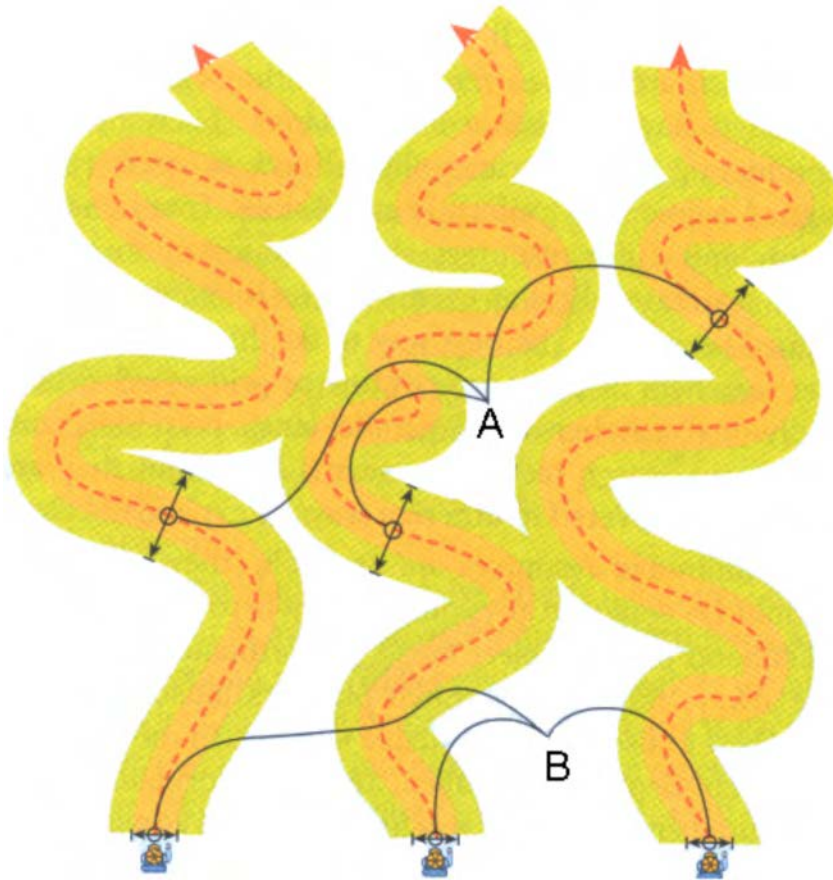

Figure 1 Loose Grid Search—Example 1

Note. From *Fundamentals of Search and Rescue* (p. 244), by National Association for Search and Rescue. 2005, Mississauga, ON: Jones and Bartlett Publishers Canada. Copyright 2005 by Jones and Bartlett Publishers, Inc.

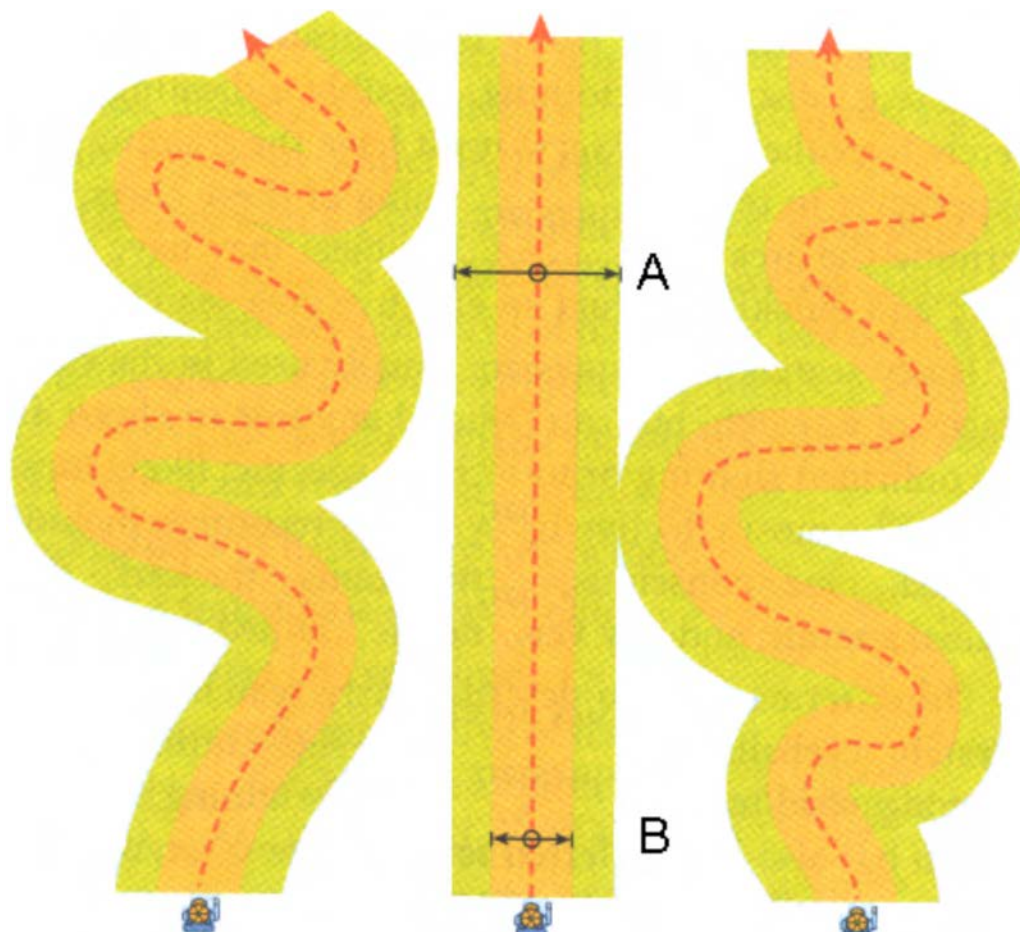

Figure 2 Loose Grid Search—Example 2

Note. From *Fundamentals of Search and Rescue* (p. 244), by National Association for Search and Rescue. 2005, Mississauga, ON: Jones and Bartlett Publishers Canada. Copyright 2005 by Jones and Bartlett Publishers, Inc.

Tight Grid Search

A tight grid search is a slow, highly systematic area search. It is generally used when a very thorough, high-coverage search is required. This involves searchers lining up on a baseline, relatively close together. They then proceed along straight, parallel, equally spaced tracks, scanning the area. Since searchers are close together, there will be a visual overlap by adjacent searchers into the other person's area.

The goal of a tight grid search is to minimize the chances that a clue or the missing person will remain undetected. The team is normally comprised of four to seven searchers.



Other terms used to describe tight grid searches include closed grid, sweep searches, Type III searches and saturation searching.

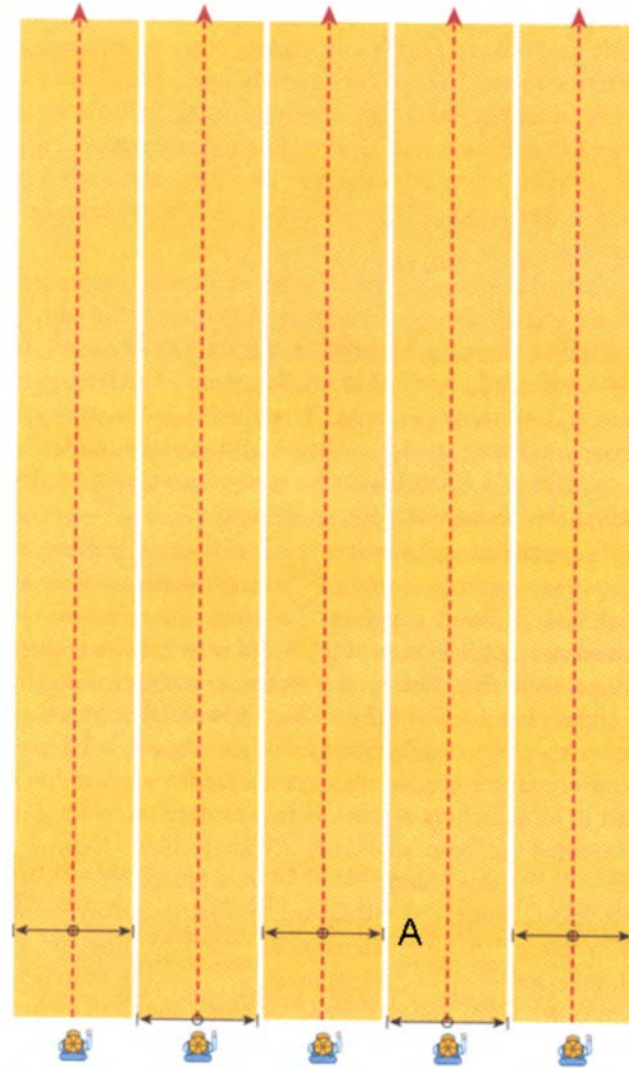

Figure 3 Tight Grid Search Example

Note. From *Fundamentals of Search and Rescue* (p. 246), by National Association for Search and Rescue. 2005, Mississauga, ON: Jones and Bartlett Publishers Canada. Copyright 2005 by Jones and Bartlett Publishers, Inc.

CONFIRMATION OF TEACHING POINT 6

QUESTIONS:

- Q1. What is a hasty search?
- Q2. The goal of this type of search is to cover a large geographic area quickly, with few resources.
- Q3. What type of search team is normally comprised of three to seven searchers?

ANTICIPATED ANSWERS:

- A1. A hasty search does not have definable boundaries. This type of search is used to discover evidence / the missing person quickly by visiting general locations where they are likely to be found (eg, campsites, abandoned vehicles, roads, trails).
- A2. A loose grid search.
- A3. A loose grid search team.

QUESTIONS

- Q1. Describe the steps of the STOP procedure.
- Q2. What is a string line?
- Q3. When should emergency services be contacted?

ANTICIPATED ANSWERS

- A1. Once it is determined that one is lost, the best thing to do is to stay in one place, keep calm and try to gather information to determine one's location. It is extremely important to concentrate on making good decisions.

STOP is a mnemonic for:

- **Sit.** Stop where you are! Do not panic. Many lost people waste valuable energy and risk injury by panicking—running aimlessly, continuing to travel after dark, or walking in circles. If a lost person decides to immediately wander in an attempt to find their location, in most cases they will move further away and increase the distance between the known points of their course. This will only increase the size of the search area, increasing the time it will take for a rescue team to locate an individual. As long as there is no immediate danger, stay in one place. During the first 30 minutes of being lost is when people tend to make their biggest mistakes. Making good decisions about the situation involves thinking through options without panicking.
 - **Think.** Think about immediate and future dangers and the factors involved in the situation. Consider the time of day, personal physical condition and the last time water or food was consumed. Try to list the options that are available.
 - **Observe.** Observe and listen for the signals of rescuers. Study the immediate environment, determining weather, terrain and resources available. Check the immediate area for a shelter location, fresh drinking water, and for clues of the current location.
 - **Plan.** Plan the best course of action. It could be close to dark and consideration should be given to setting up shelter, finding water or starting a fire. A safety bearing could have been provided prior to beginning the activity and consideration should be given to use it or not. Include how to signal rescuers in the plan.
- A2. As searchers make their way through the perimeter of an area, one person carries a spool of string. As they walk through an area, the string unrolls, leaving a visible trail. The string then serves as a perimeter to confine the missing person, as well as a sign that assistance is nearby.
- A3. There are no hard and fast rules that state when emergency services should be contacted after a person becomes lost. Answers will vary.

CONCLUSION

HOMEWORK / READING / PRACTICE

Nil.

METHOD OF EVALUATION

Nil.

CLOSING STATEMENT

A person can become lost simply by leaving a tent to go to the washroom and becoming disoriented or by following an incorrect compass bearing on a hike. Cadets participating in an activity should be aware of the actions they must take when lost, as it will increase the chances of them being found quickly.

INSTRUCTOR NOTES / REMARKS

Nil.

REFERENCES

C0-111 ISBN 0-9740820-2-3 Tawrell, P. (2006). *Camping and wilderness survival* (2nd ed.). Lebanon, NH: Author.

C2-009 ISBN 0-684-85909-2 Harvey, M. (1999). *The national outdoor leadership school's wilderness guide*. New York, NY: Fireside.

C2-016 ISBN 0-517-88783-5 Curtis, R. (1998). *The backpacker's field manual: A comprehensive guide to mastering backcountry skills*. New York, NY: Three Rivers Press.

C2-069 ISBN 0-9694132-0-3 Ferri, G. F. (2000). *The psychology of wilderness survival*. Hanover, ON: Skyway Printing.

C2-229 ISBN 0-913724-30-0 LaValla, P. (1999). *Search is an emergency, field coordinator's handbook for managing search operations*. Olympia, WA: ERI International, Inc.

C3-208 ISBN 978-0-7637-4807-4 National Association for Search and Rescue. (2005). *Fundamentals of search and rescue*. Mississauga, ON: Jones and Bartlett Publishers Canada.



ROYAL CANADIAN ARMY CADETS

GOLD STAR

INSTRUCTIONAL GUIDE



SECTION 6

EO C425.02 – ANALYZE PROBLEMS USING AN EXPEDITION CASE STUDY

Total Time: 270 min

PREPARATION

PRE-LESSON INSTRUCTIONS

Resources needed for the delivery of this lesson are listed in the lesson specification located in A-CR-CCP-704/PG-001, *Gold Star Qualification Standard and Plan*, Chapter 4. Specific uses for said resources are identified throughout the instructional guide within the TP for which they are required.

Review the lesson content and become familiar with the material prior to delivering the lesson.

Photocopy the Case Study Worksheet located at Attachment A. One copy is required for each cadet and each group.

There are eight case study examples located at Attachment B. The difficulty level of the case study increases by number. If attempting a case study for the first time, it is recommended that a lower number case study be chosen. Select a case study to use, become familiar with it and photocopy it for each cadet.

A case study may generate a lot of class discussion. Keep the discussion on track. Develop a list of open-ended questions to use throughout the activity. Some examples of open-ended questions are:

- How did you make that choice?
- What would you do differently?
- Why do you feel that way?
- What do you think would have happened if...?
- What does that mean to you?
- Is there another way of looking at it?
- Why is that important?

PRE-LESSON ASSIGNMENT

Nil.

APPROACH

A case study was chosen for this lesson as it allows the cadet to analyze problems using expedition case studies.

INTRODUCTION

REVIEW

Nil.

OBJECTIVES

By the end of this lesson the cadet shall have analyzed problems using an expedition case study.

IMPORTANCE

It is important for cadets to analyze expedition-based problems. Using expedition case studies is a great way to help build better judgment and decision-making skills. Real-life cases can be analyzed and problems / issues debated without the risk of poor decisions causing harm. Using case studies helps to build confidence to make decisions later.

Teaching Point 1**Have the cadets complete an expedition case study activity.**

Time: 80 min

Method: Case Study

**CASE STUDY**

In the case study method, the cadet is provided with the opportunity to consider a real-life situation. Cadets respond to a scenario by examining the facts and incidents of the case, to critically analyze data and develop solutions. Facilitate by guiding the cadets toward answers.

The method is used to challenge cadets to apply what they know to a real situation.

Using expedition-based cases is a great way to help build judgment and decision-making skills. Real-life cases can be analyzed and problems / issues debated without the risk of poor decisions causing harm. Using case studies helps to build experience.

The process is a learning opportunity. In some cases, the correct decision is rarely obvious and in many cases several different solutions could work, provided they are implemented correctly—the goal is to develop skills.



The case study method works best with relatively small groups of relatively mature cadets. The primary objective is not to find a correct solution to the problem(s) but to understand the principles involved.

ACTIVITY

Time: 80 min

OBJECTIVE

The objective of this activity is to have the cadets analyze problems using an expedition case study.

RESOURCES

- Case Study Worksheet located at Attachment A (one per cadet and one per group),
- Case Study located at Attachment B (one per cadet), and
- Pens / pencils.

ACTIVITY LAYOUT

Set up the area with tables and chairs for both individual and group work.

ACTIVITY INSTRUCTIONS

Timings may have to be adjusted, depending on the productivity of the cadets.

1. Conduct a briefing, to include an explanation of:
 - a. the objective and importance of the activity; and
 - b. the resources required to perform the activity.
2. Summarize the case study that will be analyzed during the activity.
3. Distribute a Case Study Worksheet, the case study and a pen / pencil to each cadet.
4. Allow 25 minutes for the cadets to read the case study and complete the Case Study Worksheet.
5. Divide the cadets into groups of no more than three.
6. Distribute a Case Study Worksheet to each group.
7. Allow 20 minutes for the cadets to share and discuss the answers from their Case Study Worksheets. Each group will record their group answers on the Case Study Worksheet.
8. Rotate from group to group to verify that the cadets understand the issues and answer any questions.
9. Allow 25 minutes for the cadets to discuss their answers with the entire class.
10. Elaborate on the main points through well-formed, pre-planned questions. Guide the cadets through the facts, assumptions and problems of the case study. Direct them to the cause of the problem, as well as the consequences. Lead the cadets from issue to issue and discuss critical points.
11. Conduct a debriefing on the activity by asking:
 - a. if it was difficult for the group to solve the problems in the case study (why / why not);
 - b. what issues were difficult to decide on;
 - c. why some decisions were more difficult to make than others;
 - d. how some of the issues identified in the activity relate to issues that have occurred on a previous expedition(s), if any;
 - e. what three words you would use to summarize what you learned from completing this activity; and
 - f. how this information can assist you when planning an expedition.

SAFETY

Nil.

CONFIRMATION OF TEACHING POINT 1

The cadets' participation in analyze problems using an expedition case study will serve as the confirmation of this TP.

END OF LESSON CONFIRMATION

The cadets' participation in the case study will serve as the confirmation of this lesson.

CONCLUSION

HOMEWORK / READING / PRACTICE

Nil.

METHOD OF EVALUATION

Nil.

CLOSING STATEMENT

The case study is a way to apply known concepts to a real situation. The process is a learning opportunity. In some cases, the correct decision is rarely obvious and in many cases several different solutions could work, provided they are implemented correctly—the goal is to develop skills. It is a great way to think about problems that could occur, while analyzing how they could also be prevented.

INSTRUCTOR NOTES / REMARKS

An experienced instructor shall be chosen to instruct this lesson.

This EO may be conducted as many as three sessions of three periods each during Gold Star training.

REFERENCES

A0-055 A-P9-050-000/PT-006 Director Training and Education Policy. (2002). *Canadian Forces manual of individual training and education* (Vol.6). Ottawa, ON: Department of National Defence.

C2-208 ISBN 978-1-59485-033-2 Reynolds, J., Lodato, A., Gordon, R., Blair-Smith, C., Welsh, J., & Gerzon, M. (2007). *Leadership the outward bound way*. Seattle, WA: The Mountaineer Books.

C2-250 Leemon, D., & Schimelpfenig, T. (2005). *Risk management for outdoor leaders: A practical guide for managing risk through leadership*. Lander, WY: National Outdoor Leadership School.

C2-252 ISBN 1-929148-54-2 Ajango, D. (2005). *Lessons learned II: Using case studies and history to improve safety education*. Eagle River, AK: SafetyEd: Safety Education for Outdoor and Remote Work Environments.

THIS PAGE INTENTIONALLY LEFT BLANK

CASE STUDY WORKSHEET

Case Study Title: _____

Name / Group: _____

Read the case study individually and answer the four questions below. When combined into groups, each group will be required to discuss their answers and record group answers. If extra room is required, use the back of the sheet.

1. A **fact** is something that is known to have occurred. Identify five facts that led to problems in this case study.

| |
|---|
| • |
| • |
| • |
| • |
| • |

2. An **assumption** is something that a person takes or accepts to be true, without proof, for the purpose of argument or action. Identify five assumptions you believe led to problems in the case study.

| |
|---|
| • |
| • |
| • |
| • |
| • |

3. A **problem** is a doubtful or difficult matter requiring a solution. Identify three major problems that occurred throughout the case study. Once identified, use the column on the right side to rank each problem from the most serious (# 1) to the least serious (# 3).

| | |
|---|--|
| • | |
| • | |
| • | |

4. A **solution** is an act or means of solving a problem or difficulty. Develop solutions to the problems identified in Question 3.

Solution to Problem #1

Solution to Problem #2

Solution to Problem #3

CASE STUDY #1

FORGOTTEN BATTERIES AFFECT EVACUATION

Narrative:

Three summer camp backpacking leaders were preparing for a week-long trip. They had worked with each other several times before and were looking forward to getting out of the camp and into the field. While the campers were at the lake, the leader, Sam, and his co-leaders, Sally and Bob, worked on putting together the gear in the main office. They gathered maps, first aid kits, batteries, radios and field paperwork while they reviewed student profiles and medical histories, looked at maps while chatting about the route, the chance for good fishing and maybe a peak climb. While this was going on, Bob, an avid Red Sox fan, tuned into the team's game with the New York Yankees on the television.

"Hey, the Red Sox are up by two in the sixth. Great! I hate the Yankees," Bob said.

Sam wrestled with first aid kits, watching the game intermittently as the noise of the crowd or Bob made it clear that something interesting was happening. Sally inventoried the maps and asked if they needed any route information from the climbing guide. No one answered, so she said, "Hey guys, leave the game for a minute and help me finish. Do we need the guide?"

"Naw," said Sam. "The peak is a walk. I've done it several times. Don't forget the batteries. If we don't have an evacuation, we can use them in the Walkman."

Sally commented that the radio uses batteries quickly and the spare set is essential.

Bob asked about the checklist. He didn't see it in the paperwork.

"I hate that thing," said Sam. "We never needed it until those airheads forgot the maps last summer."

Sam searched around, found the checklist, checked off its items, initialled it, and stuck it in his pocket. "Done. What's up with the game?" The trio finished their prep work with the game in extra innings and the dinner bell ringing.

"Grab the stuff, and let's go. I'll get the batteries and the maps," Bob said. He placed the batteries on the couch and turned his attention to the television, where the Yankees just took the lead from the Red Sox. "Cripes, the Yankees are the evil empire, but they win and win."

They left the room and the next morning for the field.

Two days and about 15 km (9.5 miles) up the trail, Sally fell while crossing some deadfall and badly fractured her left lower leg. It was clear they needed medical support. Sam asked for the radio. Bob quickly dug it out of his pack and tried to turn it on. The batteries were dead. Sally didn't have the spares, nor did Sam. Bob had a sudden vivid image of the batteries on the couch in front of the television.¹

¹ From *Risk Management for Outdoor Leaders: A Practical Guide for Managing Risks Through Leadership* (p. 42), by D. Leemon & T. Schimelpfenig, 2005, Lander, WY: National Outdoor Leadership School.

CASE STUDY #2
AN INAPPROPRIATE CALL FOR HELP

Narrative:

Four students were hiking 20 minutes ahead of the staff, enjoying a well-earned afternoon of independent travel. Along the way, one student tripped on a tree root and fell forward, striking her head on the ground. Momentarily stunned, then scared, she began to hyperventilate. Two of the other students in the group dropped their packs and ran back to the staff, telling them about the injury.

When they arrived on the scene, the staff found the injured student breathing rapidly and complaining of tingling in her hands and a headache. She seemed disoriented and agitated. They decided this was a severe head injury and called to request a medical evacuation. The cell phone connection was inconsistent, coming in and out, and they drained their batteries relaying the first request for immediate rescue.

After things settled down, the staff performed a more careful assessment of the student. One of them recognized that the student was hyperventilating and scared. The instructors wanted to alert the life flight, but the cell phone was dead. Unfortunately, the life flight had a serious mechanical problem during the flight and had to perform an emergency landing, winding up in a deep valley and out of radio contact. The sheriff had to send a plane to search for the first helicopter and a second helicopter to respond to the original call for help. The student was transported to the hospital where she was quickly assessed and released with a small bruise on her head.²

² From *Risk Management for Outdoor Leaders: A Practical Guide for Managing Risks Through Leadership* (pp. 39–40), by D. Leemon & T. Schimelpfenig, 2005, Lander, WY: National Outdoor Leadership School.

CASE STUDY #3

STUDENT LEFT ALONE IN REMOTE TERRAIN

Narrative:

Twelve students and two instructors decided to hike to the summit Mount Fester. The route began with 365 m (1 200 feet) of gentle, open slopes and ended with the summit cone consisting of 60 m (200 feet) of challenging Class Three boulder hopping. During the climb, the group became spaced out with one instructor at the front and the trip leader in the back with the slower students. One student in the rear began to complain of having a headache and feeling dizzy and nauseous. The leader yelled to the students ahead to let the instructor in front know that he was stopping. The message was slowly passed up the line, and it reached the instructor when she was at the base of the challenging cone. The message she heard was, "You go ahead; I'll be up later." There was no mention of an ill student.

Over the course of the next half hour, the leader had the ill student drink water and eat some snacks. He reported feeling better but not strong enough to continue the climb. The leader left him with a sleeping bag and headed up the peak. The leader met the rest of the group. They had not reached the summit because the instructor had decided it was too difficult to supervise 11 students on her own on the difficult terrain.

The leader thought he might be able to make it to the top with a smaller group. He told the instructor to pick up the ill student during the descent to camp. The leader then continued to the summit with two students.

The instructor, however, did not find the resting student. She figured the student might have returned to camp on his own, but when she and her group arrived at camp, the ill student was nowhere to be found. The instructor then climbed back up the mountain to search for him.

During this time, the other leader and his group descended to camp by a different route. When he got to camp and learned about the situation, the leader returned on his own to the location where he had left the student. The missing student was still there, sleeping. He said he felt fine and returned to camp. An hour later, the other instructor and her search group returned to camp.³

³ From *Risk Management for Outdoor Leaders: A Practical Guide for Managing Risks Through Leadership* (pp. 40–42), by D. Leemon & T. Schimelpfenig, 2005, Lander, WY: National Outdoor Leadership School.

CASE STUDY #4

GROUP LOST ON FIRST DAY OF EXPEDITION

Narrative:

Charlie and Henry, wilderness instructors for a wilderness program, arrived with their students at their planned drop-off point late one afternoon. The previous day, preparation day, had been difficult for the instructors. Henry, the trip leader, had been assigned to the course at the last minute, and was not happy about it. He complained about leading adolescents and suspected that this assignment was punishment for complaints about his previous trip, on which students said he was short-tempered, distant and difficult to approach.

During the preparation day, Henry criticized Charlie for miscalculating the amount of stove fuel they would need. Then, after Charlie had evenly distributed the group's gear, Henry reorganized all of it in front of several staff members while grumbling about poorly-trained new staff. Charlie's explanation that he had divided the gear as instructed fell on deaf ears.

The drop-off point was in thick forest with rolling hills and few distinct landmarks. As the van pulled away, Charlie and Henry looked at their maps and prepared to hike to the "X" (the destination for camp) in separate groups. Henry pointed to where they were, and marked an "X" where he wanted them to meet in a few hours. Charlie was concerned. He didn't think they were starting where they thought they were. He mentioned this to Henry, who replied irritable, "No, we are at the correct spot. I've been here several times before."

Unconvinced, Charlie used his Global Positioning System (GPS) receiver and plotted their position. It showed they were 700 m (2 300 feet) northeast of where they thought they were on the map. He pointed this out to Henry who bluntly replied, "I don't need that crutch. I can read a topographical map."

Henry then left with his group and Charlie left about a half hour later. After walking through a maze of two-track dirt roads, Charlie was convinced they were disoriented and pulled out his GPS. Using this he navigated to the "X," arriving at dark. The other group was not there. Charlie did not know what else to do, so he made camp. In the meantime, Henry hiked to his "X," and of course Charlie was not there.

Charlie waited that night and all of the next day for Henry to arrive. Henry also waited for Charlie, and at noon the next day he hiked with his group back to the drop-off point thinking that Charlie would return there. When Charlie did not show up that evening, Henry called the base on his cell phone (Charlie didn't have one) and said he had lost a group. He was obviously irritated and complained about these "new instructors who can't navigate."

The support staff at the base plotted on a map the coordinates Henry gave them for the "X," and arranged for an aircraft to fly one staff person over the area first thing in the morning. After their second pass over the area, they saw a bright flash of light coming from a small clearing—it was Charlie. Support staff contacted a very irritated Henry on his cell phone and told him Charlie was in the right place waiting for him.⁴

⁴ From *Risk Management for Outdoor Leaders: A Practical Guide for Managing Risks Through Leadership* (pp. 42–43), by D. Leemon & T. Schimelpfenig, 2005, Lander, WY: National Outdoor Leadership School.

CASE STUDY #5

RAPPELLED OFF THE END OF THE ROPE

Narrative:

An instructor (Tyrell) and student (Beth) were rappelling from the top of Block Tower. The first rappel was tricky because the end of the rappel could not be seen from the top anchor and belay. Knowing that Beth would be out of sight and that communication would be difficult, the instructor gave Beth explicit instructions on what to do and what to expect. He described the rappel route in detail, including what the next rappel station would look like and how to clip into the anchor bolts.

Beth said she understood the instructions and, although she was tired, Tyrell believed she had been attentive. As Beth rappelled, he used the belay to judge when Beth would reach the anchor. Beth stopped at the anticipated belay point, then, after a few moments pause, continued to slowly descend. The belay slack disappeared and then the belay loaded. To Tyrell, it was obvious that Beth had just rappelled off the end of her rope.

Tyrell was able to tie off the belay rope and remove himself from the belay anchor. He then secured the belay rope and prepared to descend on the rappel line. This took about 10 minutes. He rappelled to a ledge where he could walk out to its outer edge and look down. He saw Beth hanging well below the ledge of the next rappel station with the rope passing directly over the anchor bolts. Tyrell quickly descended to the anchor at the second rappel station and clipped in. It was now clear that Beth had in fact rappelled directly over the anchor and, after stopping and looking at it, had for some reason continued downward.

Beth was hanging against a vertical face and could not climb up. Tyrell built an anchor and set up a pulley system using the free rappel line. He raised her to a small ledge where she could stand and then placed her on belay so she could climb an easy part of the face to his ledge. He then clipped her in, took apart the raising system and climbed back to the anchor above. After returning to the ledge, they continued to descend without incident.

Beth had no real explanation of why she continued rappelling. This was not her first multi-pitch climb, and she had previously shown attentiveness to details and reliability. She said she stopped and looked at the anchor but was having a good time rappelling and was "spacing out." She said, "It was feeling really neat," so she continued to rappel.⁵

⁵ From *Risk Management for Outdoor Leaders: A Practical Guide for Managing Risks Through Leadership* (p. 39), by D. Leemon & T. Schimelpfenig, 2005, Lander, WY: National Outdoor Leadership School.

CASE STUDY #6

PARTICIPANT KILLED IN AN AVALANCHE

Narrative:

At 9:30 am on Day Five of a 10-day backcountry ski trip in Wyoming, a group of 11 students and two leaders set out to ski 5 km to the base of Patterson Peak. They planned to break trail for their next campsite, and once there, they would mound snow for snow shelters (they had planned to move into this camp the next day).

Willy, one of the leaders, was at the front of the group. Dave, the other leader, was at the back of the group, about 15–20 minutes behind. During the morning, as they crossed some flat areas, Dave felt a collapse of the snow pack. He did not think it was indicative of any instability in the snow pack, however, and did not mention it to Willy.

About mid-morning, the group broke out onto a 20-degree open slope, facing north-northeast. They could see that it extended uphill about 30 m (100 feet), gradually increasing in steepness up to a tree band. Above the band of trees and not immediately obvious to the leaders or anyone else in the group, the slope steepened for about 120 m (400 feet) as it rose to a cliff band. Willy decided that neither the slope nor the snow pack was a danger. He made a gradual descending traverse across the slope to the valley bottom and the future camp location and the rest of the group followed.

Willy and Dave discussed whether to return by the route they had come or break a different trail back to the existing camp. Willy liked the route they had just travelled. Dave wanted to avoid crossing the same slope. He felt it would be difficult for students carrying full packs and pulling sleds when they moved camp the next day. While he did not say so, he was also concerned about a slope on the route that he thought posed an avalanche danger, and this, along with the collapsing snow he felt earlier, made him want to establish an easier route back. The two instructors had a brief conversation about which route to take but failed to reach a decision. For the next hour and a half, they busied themselves making snow shelters.

At about 1:40 pm, a student, Steve, came to Willy and Dave complaining of pain in his feet. Willy inspected Steve's feet and decided that the group needed to head back to camp. Again, Willy and Dave discussed the route. Willy felt that using the already broken trail would be more efficient and would allow them to get Steve back to camp more quickly. Dave concurred.

Willy started out leading the group back on the existing trail, and Dave brought up the rear. Willy re-emphasized to the group what to do in the event of an avalanche, including skiing downhill, struggling to stay close to the surface, and creating an air pocket. Though Willy did, by now, recognize the slope as a possible avalanche slope, he didn't think it was threatening, and so he didn't establish spotters or have the students ski across one at a time.

When Willy got across, he turned to watch the students. Suddenly he heard a sound (like a crack) from up slope, and looking up, he saw the avalanche. He yelled at the students in the slide path—five of them—to "ski down!" Steve was already out of the way. Denise easily skied out of the path. Frank and Molly skied downhill and to the side, but were caught by the avalanche.

Roger looked at the avalanche and then at Willy, and then waved his arms and yelled. He did not attempt to ski down out of the slide path, even though he was a capable skier. The slide caught Roger and carried him down slope. He was on the surface for 6–8 m (20–25 feet) before being buried.

When the snow stopped moving, Frank was buried to his chest and Molly was buried to her waist. Willy saw that Frank and Molly were not in imminent danger; he focused his attention on Roger.

About five or six minutes after the slide ended, Willy located Roger by using an avalanche transceiver and quickly uncovered his face. Roger was buried about 1 m (3 feet) under the surface. He was completely encased in snow and was not breathing. There was no pulse. Rescue breathing was begun immediately and chest compressions were started as soon as his chest could be uncovered. The efforts were continued for two hours. Unfortunately, they were unsuccessful.⁶

⁶ From *Risk Management for Outdoor Leaders: A Practical Guide for Managing Risks Through Leadership* (pp. 44–46), by D. Leemon & T. Schimelpfenig, 2005, Lander, WY: National Outdoor Leadership School.

CASE STUDY #7

ADAM'S STORY

Narrative:

In the summer of 1998, Adam Dzialo was 12 years old. He loved sports and was good at everything he played. When he wasn't playing a sport, he was at a sports camp. Adam's family had a busy summer planned for him. He was signed up for six sports camps, including hockey camp which was going to be his first week away from home and Team Adventure, an outdoor program run by the local community college. The Team Adventure brochure promised "five days of fun and excitement!" featuring a ropes course, rock climbing, canoeing, hiking, a river crossing and one overnight camping trip.

The Team Adventure activities were designed to introduce participants to different types of outdoor skills or experiences each day. On many of the earlier trips, participants complained about the Friday hike—it wasn't exciting enough. Heather and Patrick (the team leaders) asked for permission to alter the itinerary for the group and try a river swimming and rescue drill instead. Permission was granted. The group would hike to the summit on Thursday and on Friday, a hike to Deerfield River, where the group would complete river activities.

On Friday morning, the group broke camp and headed for the river, stopping briefly along the way to get the water release time. The river's flow was controlled by scheduled water releases from the nearby dam. Heather and Patrick wanted to time their activities so that they could be finished before the full force of water hit the group. Before the release, the river is a shallow stream. Afterward, it rises gradually and progressively as a bubble of water makes its way down the riverbed.

After obtaining the water release time, the leaders knew they had a few hours, so there was no need to rush. The group stopped for lunch and the leaders discussed how to read water and fitted everyone with life jackets. They tested each jacket by attempting to lift it over the person's head. At just under 90 pounds, Adam was a little small for an adult-sized life jacket, but it passed their test and they decided it was an acceptable fit.

The chosen location seemed like an excellent choice for a swimming and rescue drill, and had been used for that kind of activity many times by multiple organizations. On the bank, the group was split into two teams. The swimmers went upstream with Patrick while the rescuers went downstream with Heather. They were about 60 m (200 feet) apart.

Upstream, Patrick provided a briefing for the swimmers, explaining where to swim, the proper position, how to grab the throw bag, and what to do if the throw bag missed. It had been predetermined that before each boy went, Patrick would look both ways and give a thumbs-up sign to Heather to indicate he was ready. When Heather returned the sign, the swimmer would be free to go.

Downstream, Heather explained the proper use of throw bags to her group and positioned two rescuers near her side along the bank. The plan was that if the first throw bag missed the swimmer, the second person would throw their bag.

No one was required to participate and some opted out.

During mid-afternoon, the leaders brought the group together. Patrick had to drive someone upstream to meet his mother at a prearranged pick-up point. He was expected to be back in 10 minutes. Heather said she felt comfortable continuing the exercise, so some people went back upstream to take another run at the river. Heather stayed downstream with the rescuers. The signalling system would be the same, but the swimmers would decide for themselves when to enter the water.

When it was Adam's turn, the full release from the dam had arrived and commercial rafts, with guides, were beginning to appear. Adam floated in the water in a seated position. He waved to his friends downstream and then appeared to stand up. His body flipped over and he then disappeared under the water.

Heather ran upstream along the shore and tried to swim out to Adam. The current forced her back downstream. During the next few minutes, several rafting guides were ashore and joined the rescue operation. Several attempted to reach Adam. All of them were swept away by the current. Some of the guides tried to create a "human chain" to reach him, but the current was too strong.

With the aid of rope, the group created a "tag line" and a few minutes later Adam was reached. One guide was able to get a firm grip on Adam's life jacket. He let go of the rope and pulled as hard as he could. He was able to pull the life jacket free, but Adam's foot was lodged.

Because there was too much slack in the tag line, trees were added as anchor systems and additional ropes were used to pull the tag line taut. Four men attached a raft to the line across the river and manoeuvred it as close as they could to where Adam was trapped. They were finally able to get Adam's head above water and could start rescue breathing. Two other men worked to pull Adam's foot free. He had been under the water for 25 minutes.

Patrick had returned, several people had called 911 and emergency personnel had already arrived on the scene. Within minutes, Adam was transferred to an ambulance, carried to a nearby heliport and flown by helicopter to a hospital.

After the first 72 hours, the doctors told Adam's family that he would live. However, they held very little hope for a full recovery. Adam had suffered from "anoxic encephalopathy" as a result of the near drowning—the neuromuscular system that controls movement had been damaged.

After the accident, now 19 years old, Adam needs assistance with every aspect of daily living. He attends physical therapy five times a week, speech therapy four times a week and Advanced Biomechanical Rehabilitation exercises three times a week. He communicates with his eyes, laugh and smile. He cannot walk. His parents remain optimistic that he will, one day, walk and talk again.⁷

⁷ From *Lessons Learned II: Using Case Studies and History to Improve Safety Education* (pp. 5–26), by D. Ajango, 2005, Eagle River, AL: SafetyEd: Safety Education for Outdoor and Remote Work Environments.

CASE STUDY #8

SEA KAYAKERS STRANDED IN DARKNESS AND FOG

Twelve kayakers and two instructors pushed off on the final expedition day of the Boundless Experiences Inc. eight-day kayaking course at Rigarogy Island, in the waters of southern Ireland's Baltimore Bay. The distance for the day of paddling from Rigarogy Island to Cleare Island was approximately 35 km (20 miles) among the islands of the bay, with several crossings of open water. There were many small craft warnings for southwest winds of 27–37 km per hour (15–20 knots). The waves were choppy and up to 1 m (3 feet) high and rain was in the forecast. In addition, the group had had a few nights of short sleep.

Shannon, the assistant trip leader, checked in with the six women and six men in the group, who ranged in age from 19–58, while they were preparing breakfast to give a pep talk and assess their physical condition as well as their spirits. She then reported to Zachary, the very experienced 40-year-old leader. They discussed the plans for the day, and he made the judgment call that, even though the weather conditions, travel distance, and group fatigue levels were not ideal, the group would go ahead with the schedule and have the final expedition day, which would be led by the students. Though all of the students received appropriate training, Zachary and Shannon knew that, given the weather conditions, they would need to stick pretty close behind the students when paddling, just in case assistance was required.

A couple of hours later after launching, the fleet of four single and five two-person kayaks were heading west across open water, Nash (in a single kayak) capsized. Instead of staying in close convoy with the rest of the group, he had once again split off from the group. But he successfully performed a wet exit, and the crew rallied quickly to get him back into his kayak. His boat was then pumped dry and the crew continued on, arriving at Hare Island, the lunch destination, at 1:30 pm.

At lunch, Zachary and Shannon wanted to update the base on the group's progress, but also wanted to save the two-way radio's batteries for emergency use because the very high frequency radio's rechargeable batteries had not been swapped at the start of the expedition for ones that would maintain charge for longer. Zach decided to use his cell phone to call the base and change the estimated time of arrival from 3:00 pm to 5:00 pm. No one answered, so he left a message and planned to call again later in the afternoon.

At 2:30 pm, Shannon tried to reach the base, this time with the radio, but had no luck. Most students opted to wear wetsuits for the rest of the day. At 3:00 pm, the crew ensured there was no trace of the visit left at the site and the group set off. There was approximately 13 km (8 miles) farther to the base.

By late afternoon, it was raining hard. The group was approaching the end of a channel, so they rafted up so that they could check their maps and compasses, since, as had often been the case, they were having trouble agreeing on exactly where they were and what course to follow.

The group made good time heading southwest past a string of small islands, though were still behind schedule. At 5:30 pm, Zachary moved up ahead of the students, taking the lead and urging everyone to keep up the pace behind him.

By 7:30 pm, the sun became lost behind the clouds and fog could be seen. There was still 5 km (3 miles) left. Twenty minutes later, in the fog and dwindling daylight, the group decided to tighten the convoy, leaving only about 30 m (100 feet) between the front and back of the line. There were wind and waves coming in from the south—the direction of travel.

Zachary called the group together and checked to see how everyone was doing and whether everyone was prepared to make the final push. He was familiar with the area and estimated that it would take 10 minutes to cross the area. None of the students spoke up.

Zachary gave the group the heading of 180 degrees magnetic and firmly stressed the need to maintain a close convoy formation. Kelly, who was tired and concerned about the coming darkness, asked that another, stronger

two-person kayak be appointed to stick close beside her and her partner, but Zachary reassured her that the entire group would be sticking together, so such a buddy system would not be needed.

A few minutes before 8:00 pm, the group was enveloped in fog and waves. Although the wind had somewhat dropped, Zachary (guided by his compass, which was mounted on his kayak) headed the convoy, with Shannon in the middle of the back half. There was now approximately 12 m (40 feet) between the front and back of the kayak line. There was a green buoy ahead to the left, but the group could not make out its number. Zachary believed it was buoy Number 13, which confirmed his sense that the group was right on course.

By this time, darkness and fog had made it impossible for Zachary to read his compass, so he tried to use the direction of the parallel rows of incoming waves as a navigational aid. He was unaware that there were refracting waves—a condition in which the lines of waves make an arc as they swing past a point of land. The result was that the waves were coming in more from the west rather than south, as Zachary was predicting.

With the size of the waves, the group was having trouble maintaining the close convoy without bumping into each other. It was also difficult to see everyone, so the group started shouting back and forth to maintain contact.

Zachary called Shannon up to his kayak to ask her to try to read his compass. The compass indicated that the group was heading west, rather than south. To make sure, Zachary borrowed a hand-held compass from the closest kayak. The compass confirmed that the group was 90 degrees off course. By this time Zachary, like the rest of the group was stretched pretty thin from fatigue, and possibly dehydration, so it was understandable when he turned his kayak around and headed north for a few minutes. He did a 180-degree turn, and the group followed him south, continuing to use voice contact to keep together.

Soon the group could only hear the sound of waves crashing into rocks. Zachary shouted for all of the kayaks to gather. Two two-person kayaks did not show up, and the rest of the group, already quite apprehensive, were screaming back and forth as they tried to bunch the kayaks together while they bounced and dipped into the waves. The students were starting to panic.

A minute or two later, at about 8:30 pm, a flare illuminated in the gloom. Zachary told Shannon to remain with the pod of kayaks, and, shouting and blowing his whistle, he rapidly set off toward the rocks in search of the missing students. Moments later he found one of the kayaks next to a rocky ledge. Martin and Margaret told him that the two women from the other kayak, Kelly and Ruth, were standing on the ledge with their kayak pulled up beside them, and that they had set off the flare. Zachary told Martin and Margaret to paddle back to the others, using whistles and shouts as a guide.

Zachary could now see Kelly and Ruth's silhouettes on the ledge, so he yelled to them to ask if they were okay. They replied that they were okay and able to stay on the ledge, in spite of the rising tide and the breaking waves. Zachary assured them that they would be helped off the ledge as soon as possible.

Zachary returned to the rest of the group and briefed them on the situation. He then tried to get his jacket and flashlight out of his rear hatch and the two-way radio from under his rear deck. He retrieved the radio and called the base. In an even voice, he informed the volunteer on duty of the situation and requested that a motor vehicle be quickly sent to assist. It was now approximately 9:00 pm. Zachary called to check on the rescue efforts and was informed that a motor vehicle was on the way. By 9:45 pm, there were still no sign that help was on the way.

Twenty minutes later, Shannon set off an emergency flare. The group could make out a large motor vehicle coming toward them. All group members were rescued.

Careful assessment by senior staff members determined that none of the students or instructors would need medical attention.⁸

⁸ From *Leadership the Outward Bound Way* (pp. 213–219), by J. Garrett, 2007, Seattle, WA: The Mountaineers Books.

THIS PAGE INTENTIONALLY LEFT BLANK



ROYAL CANADIAN ARMY CADETS
GOLD STAR
INSTRUCTIONAL GUIDE



SECTION 1

EO M426.01 – PREPARE FOR EXPEDITION TRAINING

Total Time: 30 min

PREPARATION

PRE-LESSON INSTRUCTIONS

Resources needed for the delivery of this lesson are listed in the lesson specification located in A-CR-CCP-704/PG-001, *Gold Star Qualification Standard and Plan*, Chapter 4. Specific uses for said resources are identified throughout the instructional guide within the TP for which they are required.

Review the lesson content and become familiar with the material prior to delivering the lesson.

Obtain necessary examples of outdoor clothing, equipment and high-energy snacks.

The joining instructions and training schedule referred to in TP 2 will vary depending on the region. Acquire these documents from the local expedition centre.

Photocopy the Navigation Review Package located at Attachment A for each cadet.

If the expedition centre is conducting cold weather activities (snowshoeing / skiing), TPs 1 and 2 will have to be altered. Information is available in EO C121.03 (Select Cold Weather Clothing) and EO C121.04 (Recognize the Effects of Cold Weather).

PRE-LESSON ASSIGNMENT

Nil.

APPROACH

An interactive lecture was chosen for TPs 1 and 2 to orient the cadet to the selection of expedition equipment and expedition training.

An in-class activity was chosen for TP 3 to give directions to the Navigation Review Package that will be completed prior to attending the Gold Star expedition.

INTRODUCTION

REVIEW

Nil.

OBJECTIVES

By the end of this lesson the cadet shall be expected to prepare for expedition training.

IMPORTANCE

It is important for cadets to understand the importance of preparing for expedition training as a way to ensure everyone is comfortable when participating in an expedition. Reviewing the joining instructions prior to undergoing training as well as completing a navigation review will assist cadets in preparing for expedition training.

Teaching Point 1**Review the selection of clothing and equipment for an expedition.**

Time: 10 min

Method: Interactive Lecture



This TP is designed to familiarize cadets with the proper clothing and equipment to pack for expedition training. Cadets should have knowledge of this subject from previous expedition training.

Have examples of outdoor clothing, equipment and high-energy snacks available if possible.

Customize the lesson to the anticipated weather for the respective expedition centre and its activities. Cadets should be advised to check the weather forecast prior to the training.

CLOTHING

The most effective way to maintain warmth and comfort in varying conditions is by using multiple layers of clothing. Layers allow one to build a microclimate that surrounds the body, which can then be adapted to moisture, wind, temperature and exertion levels.



Remember:

- It is easier to stay warm than to try to warm up after getting cold.
- It takes more insulation to stay warm when sitting still than when moving.
- Heat is lost faster to a cold solid object through conduction than to cold air through convection, which is the transfer of heat by upward movement.



Where the expedition will be held in cold weather, ensure cadets follow the principles for keeping warm.

CLEAN CLOTHING. Important for both sanitation and comfort. Dirt and grease will fill air pockets in clothes and allow the heat to escape your body more easily, leaving you feeling cold sooner.

OVERHEATING must be avoided. Overheating causes perspiration, which causes clothing to become damp. Dampness fills the air pockets in the clothing with heat-conducting moisture, permitting the body heat to escape. Overheating can be prevented by ventilation or removing layers.

LOOSE and in **LAYERS.** Clothes and footwear that are too tight restrict the blood circulation, increasing the danger of frostbite. Clothes should not be too loose either, as this allows trapped air to move, causing heat loss. Layering allows you to take clothing off before you overheat and add clothing as you cool.

Keep clothes **DRY.** Moisture will soak into your clothes from both inside and outside. Frost or snow that collects on your clothes will melt, making your clothes wet.

FOOTWEAR

Footwear is an important aspect of dressing for expedition training. Properly fitting, comfortable shoes / boots will make the cadet more comfortable during training. Low-ankle hiking boots are the ideal footwear. Finding shoes / boots that provide adequate ankle protection is important.



Combat boots or other military issue high-ankle support boots should not be worn during expedition training. Also, never wear new boots for the first time during an expedition.



Where the expedition will be held in cold weather, ensure cadets are aware that feet are vulnerable to the cold because they get wet easily, both externally and from perspiration.

The following principles are valuable when choosing and wearing footwear:

- **Ensure footwear is loose and in layers.** The layers are made up by the boot and the different combinations of socks and insoles.
- **Avoid restriction of circulation.** Two or more pairs of socks worn too tightly or tying the boot too tightly can restrict the circulation of warm blood from the body core and allow the feet to become cold.
- **Change socks and insoles as often as possible.** Since footwear often gets wetter than other types of equipment, select footwear designed to help decrease this, eg, with a rubber lower and material upper. Dry socks should always be carried, and socks should be changed as soon as possible when they become wet. If wearing heavy footwear equipped with removable insoles, such as mukluks, both socks and insoles should be changed.
- **Dry footwear when wet.** Footwear should be dried thoroughly at the first opportunity available.
- **Ensure footgear and feet are kept clean.** Footgear should be kept clean of mud and dirt, and feet should be cleaned frequently. Feet should always be exercised and massaged when changing socks.
- **Ensure all footwear fits properly to avoid chafing and blisters.** Ski and snowshoe bindings must be adjusted carefully. Improperly adjusted bindings may chafe the feet or cause excess wear and tear to the boot.

PERSONAL EQUIPMENT



Consult the joining instructions for a specific list of requisite personal kit.

Personal expedition equipment are items that benefit the participant and should be maintained by that person. Personal equipment is the kit the cadets need to carry on them.

Items to bring from home:

- **Hygiene kit.** Includes all personal items required to maintain good health and hygiene. A hygiene kit should include:
 - camp soap (biodegradable),
 - toothbrush,
 - toothpaste,
 - toilet paper, and
 - facecloth or small towel.
- **Insect repellent.** The active ingredient in most bug repellent is DEET. Many brands are available and can be purchased at most grocery stores.
- **Lip balm.** Lip balm with sunscreen will help protect lips. Lips burn easily at any elevation and cold dry winds can make lips crack and bleed.
- **Sunscreen.** A Sun Protection Factor (SPF) of 4 means that it will take four times longer to burn as when unprotected. Most sunburns can be prevented with an SPF of 15 with ultraviolet A (UVA) and ultraviolet B (UVB) protection, however an SPF of 30 or higher is recommended for most activities.
- **Sunglasses.** Protective eyewear. Sunglasses will protect the eyes from the sun.
- **Notepad and pencil.** Allows for note taking / leaving a message in any situation.
- **Water carrier.** A leak-proof water bottle or canteen to carry water.
- **Camera.** Cameras are great to record experiences.

Items that the expedition centre may provide:

- **Flashlight / headlamp.** A flashlight / headlamp should always be carried; smaller is better to control weight (be sure to have a spare set of batteries and bulb before each trip). Headlamps allow for hands-free operation.
- **Matches.** At least 20 matches that can strike anywhere and are waterproof. Store matches with a striker in a separate container inside the kit (35 mm film cases would suffice).
- **Knife / multi-tool.** Useful tool for many applications in the field. Hunting-type knives with long fixed blades are not appropriate for cadet activities.
- **Survival kit.** A kit with beneficial items to have in a survival situation. Items should be specific for the environment you will be travelling in.
- **Whistle.** For use as a signalling device in emergencies.
- **High-energy snacks.** As detailed below.



There may be a requirement for each participant to have a plate, a bowl and cutlery depending on food being consumed during expedition training.

GROUP EQUIPMENT

Group equipment should be selected for its versatility, weight, ease of use and packing. The more compact an item is or can become, the easier it will be to pack and carry.

Group equipment will be given to cadets upon arrival at the expedition centre.

HIGH-ENERGY SNACKS



Expedition centres may provide high-energy snacks. If the cadets are bringing their own snacks, encourage careful selection, as they will need to be carried.

Food is one of the most important factors to consider when expending large amounts of energy during activities. Choosing the right snacks to supplement meals is important to maintain energy and nutrition.



People are more prone to injuries at around 1100 hours and 1500 hours when blood sugar is low and people are tired from activities.

Granola Bars

Granola bars are an easy snack that can be brought on the trail with little waste. The wrapper of the granola bar can be folded and placed in a resealable plastic bag for disposal. When eating on the move, the wrapper can simply be placed in a pocket.

Granola bars come in a variety of flavours and often include chocolate. The nutrition in granola bars is largely grain based and provides a high calorie count. Granola bars often have 10–14 g of sugar and 11–16 g of fat.



Stay away from granola bars with more than 20 percent fat. These bars will only impede energy levels.

Dried Fruit and Nuts

Dried fruits last for months and keep most of their nutritional value. Dried fruit provides energy benefits without the added weight of 80 percent water content. Most grocery stores have varieties of mixed fruit, which can be dried at home.



To make homemade dried apples:

1. Slice the apples thinly.
2. Place on baking tray in a single layer.
3. Place in oven on a low temperature setting (60 degrees Celsius [140 degrees Fahrenheit]).
4. Check dryness every 20 minutes.
5. Crack open the oven door to remove moist air and improve result.

This process can take up to four hours.

Seeds and nuts are great sources of carbohydrates, protein and fat. Proteins are an essential part of any diet; known as the "don't leave home without it" snack. The high fat content will slow digestion so seeds and nuts are best used for refuelling during longer breaks. Nuts also provide magnesium, guarding the muscles against burn from lactic acid.

Cheese

A good source of dairy on the trail, cheese is a great form of calcium.



Cheese with a high moisture content does not keep well when not refrigerated for extended periods of time. Cheeses with low moisture content can keep longer. The liquefied milk fat will run off at high temperatures. While this is not a pleasant sight, it is not a sign of spoilage.

Cheeses with a high moisture content include:

- mozzarella, and
- parmesan.

Cheeses with a low moisture content include:

- cheddar,
- colby, and
- swiss.

"Good Old Raisins and Peanuts" (Gorp)

"Good old raisins and peanuts" is just that— a mixture of raisins, peanuts and anything else a person might want to add. There is often a sugar source like chocolate chips added to a dried fruit.

There are many varieties of GORP recipes. GORP can be bought in most groceries stores—pre-made—or made at home. Everyone has their favourite recipe. A person's GORP may change every expedition depending on what is available, or what they feel like eating.



Small items like sunflower seeds will settle to the bottom of the bag while larger items will float to the top. Mix up the contents of the bag before eating.



To make a simple GORP recipe:

- 118 mL (1/2 cup) peanuts,
- 118 mL (1/2 cup) raisins,
- 59 mL (1/4 cup) chocolate chips*, and
- 59 mL (1/4 cup) dried cranberries.

*In warmer weather, chocolate chips can be substituted with candy-coated chocolate that will not melt.

Mix in a bowl and store in an airtight container or resealable bag. This recipe will make 354 mL (1 1/2 cups). Substitute or add items as desired.

Examples of food items to put in GORP:

- dried apples,
- banana chips,
- dried papaya,
- dates,
- dried cranberries,
- coconut,
- almonds,
- cashews,
- peanuts,
- chocolate,
- carob chips,
- candy-coated chocolate,
- chocolate- or yogurt-covered raisins,
- sunflower seeds,
- dried green peas, and
- pretzels.

CONFIRMATION OF TEACHING POINT 1

QUESTIONS:

- Q1. What is the most effective way to maintain warmth and comfort in varying conditions?
- Q2. What are the personal items a cadet should bring to the expedition centre?
- Q3. What nutrients are in nuts?
- Q4. When are people more prone to injuries on the trail?

ANTICIPATED ANSWERS:

- A1. The most effective way to maintain warmth and comfort in varying conditions is by using multiple layers of clothing.
- A2. The personal items that should be brought to the expedition centre are:
- hygiene kit,
 - insect repellent,
 - lip balm,
 - sunscreen,

- sunglasses,
- notepad and pencil,
- water carrier, and
- camera.

A3. Nuts are a great source of carbohydrates, protein and fat.

A4. People are more prone to injuries around 1100 hours and 1500 hours when blood sugar is low and people are tired from activities.

Teaching Point 2

Brief the cadets on the joining instructions and training schedule for Gold Star expedition training.

Time: 10 min

Method: Interactive Lecture



This TP is designed to introduce and brief cadets on what is required during training at the expedition centre.

Review the joining instructions and after briefing cadets, answer any questions.

RISKS IN EXPEDITION TRAINING

Activities conducted at the expedition centres will likely include hiking, biking, canoeing and camping. Risk is the chance or possibility of danger, loss or injury. Each activity has its own risks.

Hiking is the activity of walking outdoors on unpaved trails in a wilderness environment and may include many types of terrain and environments. It is not uncommon for cadets to be injured by tripping, falling and slipping over wet roots or rocks, or falling down a small slope.

Mountain biking is riding a bike on trails and secondary roads, using specialized equipment. Cadets are at risk of falling off the bike or not using the bike properly, which may cause injury. Injuries that may occur while mountain biking are cuts and scrapes, bruising, flesh wounds, or broken bones.

Canoeing is travelling on water using a canoe. Cadets should be seated, wearing a personal floatation device (PFD) and acting responsibly. These actions will minimize the risks associated with canoeing.

Snowshoeing is the activity of walking outdoors on snow using specialized shoes. It is not uncommon for cadets to be injured by tripping, falling and slipping over ice and uneven snow or falling down a small slope. Also, with cold weather comes the risk of frostbite, hypothermia and snow blindness.

Backcountry skiing will sometimes be done on rough terrain and difficult snow. Cadets are at risk of falling and tripping. Backcountry skiing excursions require attention to traffic, road and trail conditions, weather, terrain and the capabilities of the cadets involved. Also, with cold weather comes the risk of frostbite, hypothermia and snow blindness.



Canoeing is of great cultural significance to Canadians. Canoeing in expedition training allows cadets to see Canada's wilderness from a different perspective.



Refer to CATO 40-01, *Army Cadet Expedition Program* for general expedition information.

Medical Information

Located at Chapter 1, Annex B of A-CR-CCP-951/PT-002, *Royal Canadian Army Cadets Adventure Training Safety Standards* is the Medical Information Form. This form must be completed by all cadets prior to undertaking expedition training. This form asks general questions regarding health.

Consent to Adventure Training

In addition to the medical form, the Consent to Adventure Training Form, located at Chapter 1, Annex A to A-CR-CCP-951/PT-002, *Royal Canadian Army Cadets Adventure Training Safety Standards* must be filled out by participating cadets. This form advises instructors and organizers that the cadet understands what they are undertaking and will comply with all rules and regulations.

Policies

Prior to participating in expedition training, all cadets shall be reminded of the following policies:

- CATO 11-08, *Environmental Stewardship Policy*,
- CATO 13-23, *Drug and Alcohol Policy*,
- CATO 13-24, *Harassment Prevention and Resolution Policy*,
- CATO 13-26, *Return To Unit Policy*, and
- CATO 15-22, *Cadet Conduct and Discipline Policy*.

JOINING INSTRUCTIONS

Joining instructions are issued to provide cadets with all the required information they may need to arrive at the expedition centre prepared and capable of performing the required training. They are issued for all activities outside of the local cadet corps.

Each region will have different joining instructions for each expedition centre.



Joining instructions for expedition training can be found at the regional website.

The joining instructions will have information such as:

- general information on the activity,
- directions to the expedition centre,
- dates of training,
- transportation requirements,
- what identification is required,

- administrative and claim information,
- rations and quarters information,
- uniform requirements,
- expected cadet conduct, and
- required kit list.

Joining instructions will often have a schedule / timetable included.

CONFIRMATION OF TEACHING POINT 2

The cadets' participation in the briefing for the expedition centre training weekend will serve as the confirmation of this TP.

Teaching Point 3

Describe the instructions for the Navigation Review Package.

Time: 5 min

Method: In-Class Activity

ACTIVITY

OBJECTIVE

The objective of this activity to have the cadets become familiar with and receive instructions for the Navigation Review Package.

RESOURCES

Navigation Review Package located at Attachment A.

ACTIVITY LAYOUT

Nil.

ACTIVITY INSTRUCTIONS

1. Distribute a Navigation Review Package to each cadet.
2. Allow the cadets two minutes to review the package.
3. Explain to the cadets that the Navigation Review Package is to be completed prior to attending the Gold Star expedition. The package is to be used as a self-assessment tool. If cadets experience difficulty in an area, they should review the material and seek assistance prior to attending the expedition.



There is no time allocated for the completion of the package. Each cadet is to complete the self-study package and bring it with them to the expedition centre.



Though there is no time allocated to review answers in the Navigation Review Package, the answers are located at Attachment B. Answers should be reviewed prior to the cadet attending the Gold Star expedition.

SAFETY

Nil.

CONFIRMATION OF TEACHING POINT 3

The cadets' participation in the orientation to the Navigation Review Package will serve as the confirmation of this TP.

END OF LESSON CONFIRMATION

The cadets' participation in the briefing for the expedition centre training weekend will serve as the confirmation of this lesson.

CONCLUSION

HOMEWORK / READING / PRACTICE

Cadets are to complete and take the following to the expedition centre:

- the Navigation Review Package;
- the Medical Information Form; and
- the Consent to Adventure Training Form.

METHOD OF EVALUATION

Nil.

CLOSING STATEMENT

Participating in a briefing on the local expedition centre, wearing proper clothing, bringing equipment and snacks, and reviewing navigation will help ensure all personnel are prepared for the upcoming challenges of expedition training.

INSTRUCTOR NOTES / REMARKS

This EO shall be conducted a minimum of two weeks prior to the Gold Star expedition.

Where expedition centres are completing the Gold Star expedition in cold weather, it is advised that the cadets receive cold weather training at the corps.

The joining instructions and timetable referred to in TP 2 will vary depending on the region. Instructors should acquire these from the local expedition centre.

There is no time allocated for the cadet to complete the Navigation Review Package. This package is to be completed by the cadet on their own time. Corps staff should review the completed package with the cadet prior to the Gold Star expedition.

The Navigation Review Package shall be completed and brought to the expedition centre by the cadet.

REFERENCES

A2-001 A-CR-CCP-951/PT-002 Director Cadets 3. (2006). *Royal Canadian Army Cadets adventure training and safety standards*. Ottawa, ON: Department of National Defence.

C2-051 ISBN 978-0-7153-2254-3 Bagshaw, C. (2006). *The ultimate hiking skills manual*. Cincinnati, OH: David and Charles.

C2-066 ISBN 1-4000-5309-9 Curtis, R. (2005). *The backpacker's field manual: A comprehensive guide to mastering backcountry skills*. New York, NY: Three Rivers Press.

THIS PAGE INTENTIONALLY LEFT BLANK

NAVIGATION REVIEW PACKAGE

Name: _____

Use the Sydenham Map (Figures A-1, A-2 and A-3) to answer Questions 1–7 and the Mission Map (Figure A-4) to answer Questions 8 and 9.

1. Find grid reference (GR) 551 187 and mark it as the start point (point A) on the Sydenham map. What conventional sign is located at the GR?

Answer: _____

2. Find GR 505 247 and mark it as the finish point (point B) on the Sydenham map.
3. Select a route to hike from point A to point B on the Sydenham map. Consider distance, terrain, obstacles, etc. Clearly mark the route chosen on the map and give a brief explanation below as to why the route was chosen.

4. Measure the distance along the route from point A to point B on the Sydenham map.

Answer: _____

5. Estimate the time it will take to hike the route on the Sydenham map. Remember that rates of travel will differ, depending on factors such as the group, equipment, terrain, elevation above sea level, etc.

On average, a person walks 4 km per hour, 1 km per 15 minutes or 100 m per 1.5 minutes. When off trail in open terrain, a person can be expected to travel 3 km / h. On rough, difficult terrain a person can be expected to travel 1–1.5 km / h. When gaining elevation, there should be an extra allowance of 1 hour per every 300 m. When above 3 000 m, the rate of travel will greatly decrease. Give a brief explanation as to why the answer was chosen.

6. Calculate the magnetic declination of the Sydenham map. Show all workings below.

7. Determine the magnetic bearing from point A to point B on the Sydenham map.

Answer: _____

8. Determine the contour interval of the Mission map.

Answer: _____

9. Determine the elevation at GR 390 540 on the Mission map.

Answer: _____

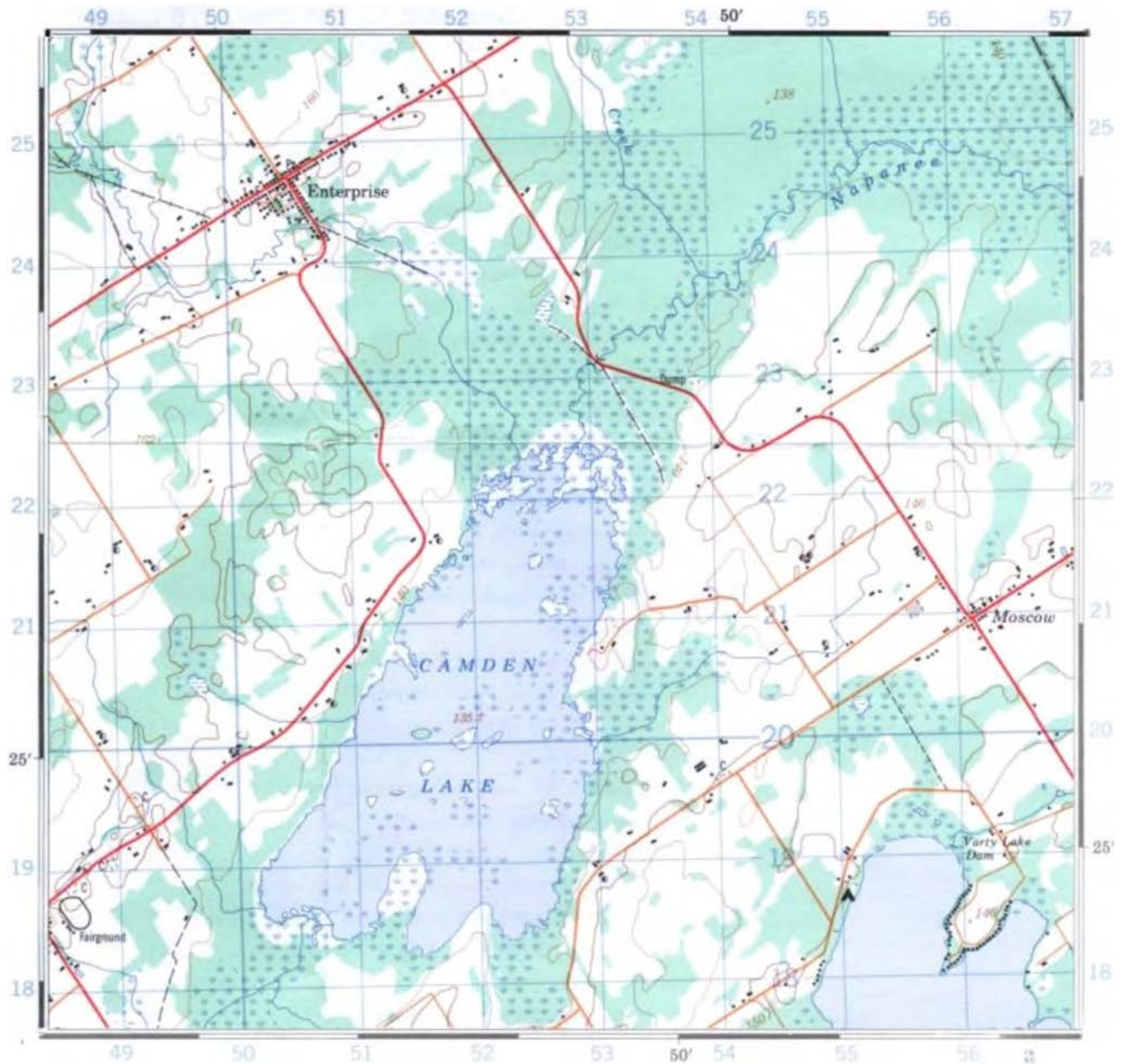

Figure A-1 Section of Sydenham Map

Note. From *Sydenham 31 C/7* (8th ed.), by Canada Centre for Mapping, 1988, Department of Energy, Mines and Resources. Copyright 1988 by Her Majesty the Queen in Right of Canada, Department of Energy, Mines and Resources.

SYDENHAM ONTARIO

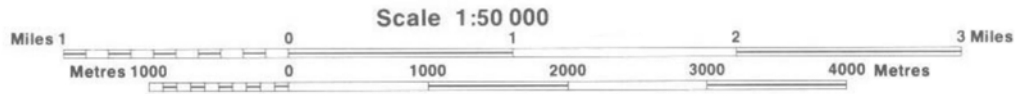

Figure A-2 Sydenham Map Scale

Note. From *Sydenham 31 C/7* (8th ed.), by Canada Centre for Mapping, 1988, Department of Energy, Mines and Resources. Copyright 1988 by Her Majesty the Queen in Right of Canada, Department of Energy, Mines and Resources.

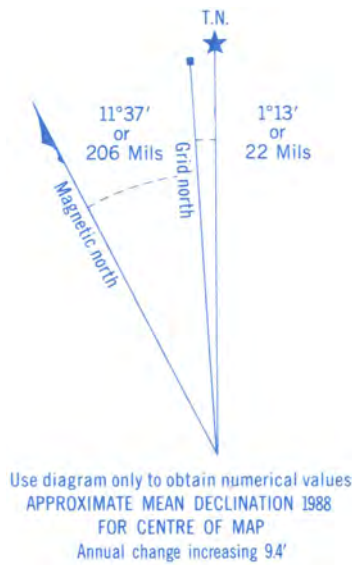

Figure A-3 Sydenham Map Declination Diagram and Information

Note. From *Sydenham 31 C/7* (8th ed.), by Canada Centre for Mapping, 1988, Department of Energy, Mines and Resources. Copyright 1988 by Her Majesty the Queen in Right of Canada, Department of Energy, Mines and Resources.

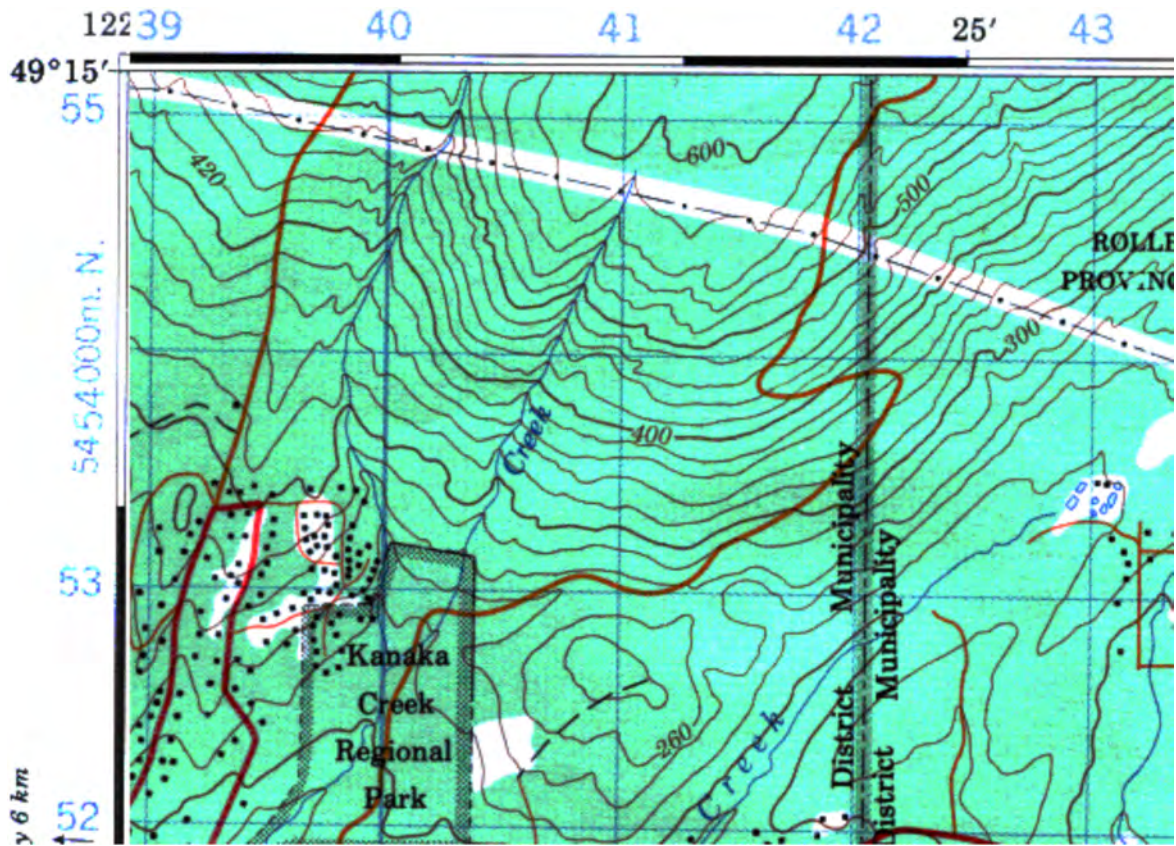

Figure A-4 Section of Mission Map

Note. From *Mission 92 G/1* (5th ed.), by Canada Centre for Mapping, 1992, Department of Energy, Mines and Resources. Copyright 1992 by Her Majesty the Queen in Right of Canada, Department of Energy, Mines and Resources.

THIS PAGE INTENTIONALLY LEFT BLANK

NAVIGATION REVIEW PACKAGE ANSWERS

1. See Figure B-1. The conventional sign is a **campsite**.
2. See Figure B-1.
3. Routes may vary. The answer provided is based on the route illustrated in Figure B-1.

The route chosen was the shortest distance. Leave the campsite and head south. Take the first road heading northwest. At intersection, head northwest. Take the trails / roads heading northwest until the intersection at GR 518 254. Head southwest until the Enterprise Intersection.

4. The distance along the route from point A to point B is **11 000 m or 11 km**.
5. The estimated time (based on the route illustrated in Figure B-1)

The terrain does not seem difficult and there are some elevation changes. The estimated time is 3 hours.

6. The magnetic declination is as follows:

| | |
|----------------------------------|-------------------|
| Current year: | 2011 |
| Year of declination information: | <u>- 1988</u> |
| Difference in years: | 23 |
| Difference in years: | 23 |
| Annual change: | <u>x 9.4'</u> |
| Total change: | 216.2' or 3°36.2' |

Annual change is increasing so it is added to the original declination:

| | |
|-----------------------|---------------------------------|
| Original declination: | W 11° 37' |
| Total change: | <u>+3° 36.2'</u> |
| Current declination: | W 14° 73.2' or W 15° 13' |

7. The magnetic bearing is **5750 mils or 323 degrees**.
8. The contour interval is **20 m**.
9. The elevation is **320 m**.

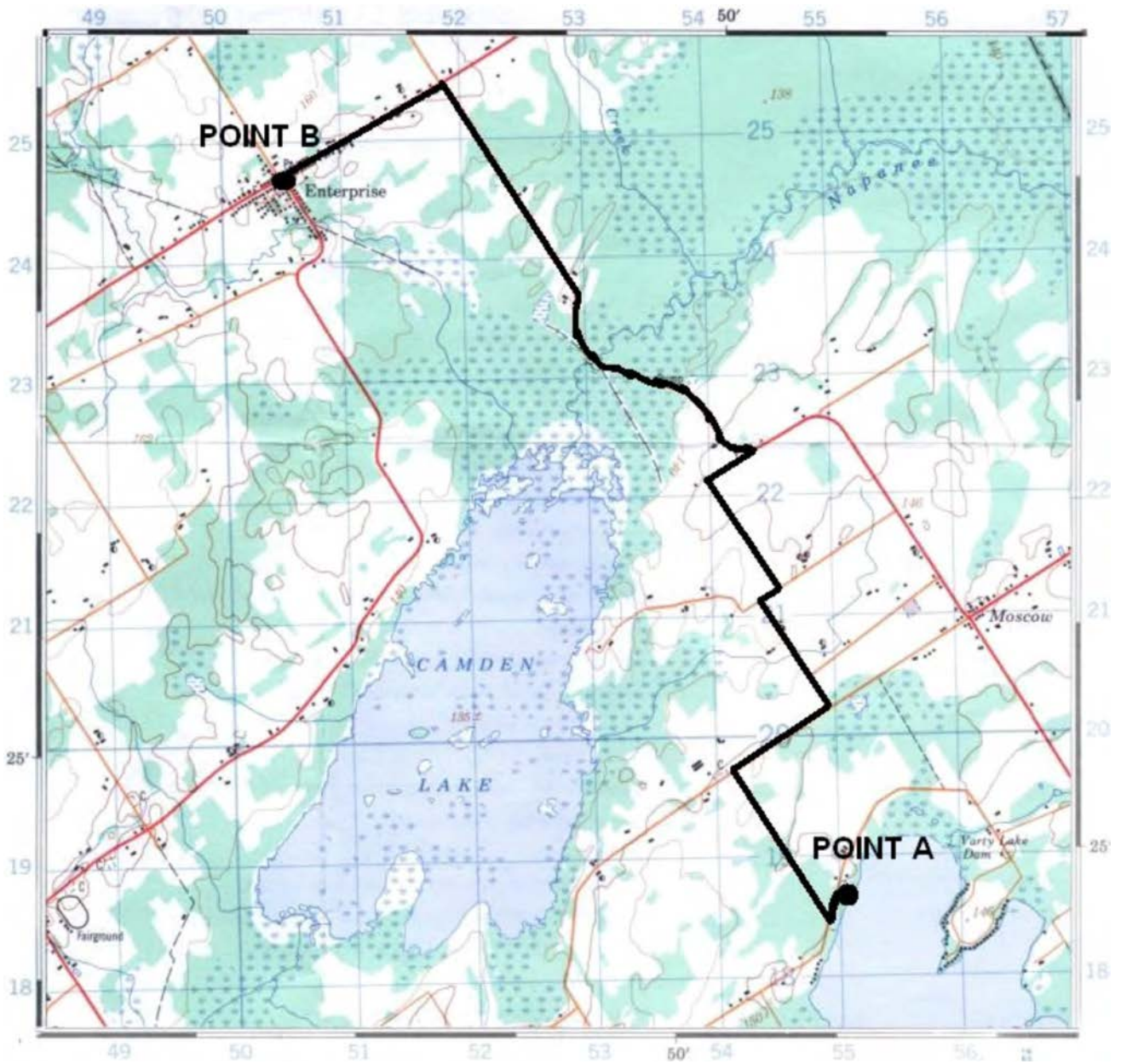

Figure B-1 Section of Sydenham Map (With Route)

Note. From *Sydenham 31 C/7* (8th ed.), by Canada Centre for Mapping, 1988, Department of Energy, Mines and Resources. Copyright 1988 by Her Majesty the Queen in Right of Canada, Department of Energy, Mines and Resources.



ROYAL CANADIAN ARMY CADETS
GOLD STAR
INSTRUCTIONAL GUIDE



SECTION 2

EO M426.02a – PADDLE A CANOE

Total Time:

270 min

PREPARATION

PRE-LESSON INSTRUCTIONS

Resources needed for the delivery of this lesson are listed in the lesson specification located in A-CR-CCP-704/PG-001, *Gold Star Qualification Standard and Plan*, Chapter 4. Specific uses for said resources are identified throughout the instructional guide within the TP for which they are required.

Review the lesson content and become familiar with the material prior to delivering the lesson.

Every cadet must have a water carrier prior to the start of this lesson.

All canoes, canoe safety equipment, personal canoe equipment, and group canoe equipment should be organized prior to the start of the lesson.

Review the canoe route. Be aware of locations where cadets may require additional supervision, such as portages.

PRE-LESSON ASSIGNMENT

Nil.

APPROACH

The experiential approach was chosen for this activity as it allows the cadet to acquire new knowledge and skills through a direct experience. The cadet experiences paddling a canoe on flatwater during an expedition and defines that experience on a personal level. The cadet will be given the opportunity to reflect on and examine what they saw, felt and thought while canoeing and consider how it relates to what they already learned and experienced as well as how it will relate to future experiences.

INTRODUCTION

REVIEW

Nil.

OBJECTIVES

By the end of this lesson the cadet shall have paddled a tandem canoe on flatwater during an expedition.

IMPORTANCE

It is important for cadets to be able to paddle a tandem canoe on flatwater during an expedition because it can provide opportunities for exploration of new places, relaxation, wildlife-watching and physical fitness. Cadets will be required to work with their canoe partner to paddle a significant distance during the expedition. Understanding stroke mechanics and being able to manoeuvre their canoe will make the expedition more enjoyable and less strenuous. The expedition will provide an opportunity to further develop paddling skills in an environment that challenges them both physically and mentally.

Teaching Point 1**Paddle a tandem canoe on flatwater during an expedition.**

Time: 270 min

Method: Experiential Learning

BACKGROUND KNOWLEDGE

The TP for this lesson will occur during the canoe portion of the expedition. In some situations, cadets will have already received instruction and been provided the opportunity to practice canoe skills during the Silver Star Expedition / at the CSTC. The requirement to review skills will be based on the experience level of the cadets and the expedition training centre. Should a review be required, it is suggested that it is completed on-water as the need arises.

IDENTIFY THE PARTS OF A CANOE

There are many different styles of canoes. The technological improvements in canoe building have made it quite difficult to choose an ineffective canoe. Despite the advances in design, the basic elements of the canoe remain the same. The parts of the canoe are:

Bow. The front section of the canoe. The bow can be easily spotted by looking at the seats. There is more leg room between the end of the canoe and the bow seat.

Stern. The back section of the canoe. Most of the steering is done from the stern.

Gunwales. The upper edges of the sides of the canoe.



Gunwales is pronounced 'gunnels'.

Thwart. A crosspiece that is attached on either side to the gunwales, two-thirds of the way back from the bow. The thwart provides structure and support to the gunwales and the hull.

Hull. The body of the canoe, which displaces water and provides the buoyancy for the canoe.

Keel. A narrow strip that runs along the centre of the bottom of the hull from bow to stern. The keel helps to provide better tracking (movement in a straight line) and stability; as well as providing a small barrier between the ground and the hull.

Bow seat. Located in the front (bow) of the canoe. It is further from the end of the canoe to provide leg room for the bow paddler.

Stern seat. Located in the back (stern) of the canoe. It is narrow and fastened to the gunwales closest to the rear of the canoe.

Bow handle. A handhold at the bow, used for lifting and carrying. It is sometimes called the bow carrying thwart.

Stern handle. A handhold at the stern, used for lifting and carrying. It is sometimes called the stern carrying thwart.

Deck plate. A triangle piece of material that is fastened between the gunwales at both ends of the canoe. It is often called the bow deck and the stern deck. The deck plate provides a convenient handhold in the case of no bow or stern handle, as well as a place to attach a painter line.



Figure 1 Parts of the Canoe

Note. From *Paddle Your Own Canoe* (p. 13), by G. McGuffin & J. McGuffin, 2005, Erin, ON: The Boston Mills Press. Copyright 2005 by The Boston Mills Press.

OUTFIT A CANOE WITH SAFETY EQUIPMENT

Every boat that enters the water has to be outfitted with certain safety equipment that is required by law. The Canadian Coast Guard and Transport Canada deem every canoe must have the following safety equipment:

Buoyant Heaving Line or Throw Bag

One buoyant heaving line not less than 15 m (49 feet) in length must be available for use in emergencies such as capsized paddlers. The heaving line shall be capable of floating and shall be attached using a figure-of-eight knot, or by clipping the throw bag to the thwart or bow handle.



A throw bag is a nylon rescue bag with a length of rope stuffed loosely inside, so it can pay out through the top when thrown to a person in the water.

Bailer

A bailer is any container capable of removing water from a canoe. It must be made of plastic or metal, with an opening of 65 cm² and a minimum volume of 750 mL. The bailer will be attached to the thwart of the canoe using a clove hitch.

Spare Paddle

In addition to the paddles used by the paddlers, a third paddle is required in the case that one is lost, broken or forgotten on shore. The spare paddle should be secured, but immediately available in an emergency. Lashing the paddle into the canoe is not recommended.

Whistle

A pealess whistle or noise-making device is required to communicate with other paddlers and to signal in case of emergency. The whistle is often attached to the paddler's PFD; if not, it should be worn on a cord around the paddler's neck.

White Navigation Light

The white navigation light is a watertight flashlight complete with working batteries. This light can be used to signal other paddlers or during an emergency. It is attached to the bow plate using a carabiner or a piece of cordage.

Painter Lines

Painter lines are two lines 6 m (19 feet) in length made of 10 mm buoyant polypropylene rope, with no knots. The lines are attached to the bow (bow line) and stern (stern line) of a canoe. They are used for pulling the canoe through shallow water and securing it to the shoreline or other stationary object. Painter lines will be attached to the bow and stern handles using a re-woven figure-of-eight knot.

PFD

A vest style jacket filled with foam panels or tubes that provide buoyancy. A PFD must be worn when an individual is within 3 m (10 feet) or less of the shoreline, prior to or upon completion of an on-water activity and when they are on the water. It is important to ensure that the PFD is properly zipped and buckled prior to moving to the waters edge.



The A-CR-CCP-030/PT-001, *Water Safety Orders*, states "the PFD shall always be worn over the outer layer of clothing. When worn, the PFD must have all fasteners and tighteners secured as they are intended to be used. A properly fitted PFD should be snug around the cadet's upper body when in or out of the water. The PFD should not ride up to the cadet's face when all fasteners and tighteners are fitted and secured. If it is riding up under these conditions, a smaller size is required."



The A-CR-CCP-951/PT-002, *Royal Canadian Army Cadets Adventure Training Safety Standards*, states that one Canadian-approved PFD or lifejacket of appropriate size must be available for each person participating in on-water activities.

IDENTIFY THE PARTS OF A PADDLE

The paddle is the most important piece of equipment required to canoe, with the exception of the canoe itself. The paddle provides the momentum to move the canoe.

Shaft. The narrow neck of the paddle between the grip and the blade.

Grip. Found at the top of the paddle shaft, where the paddler holds the paddle.

Throat. Located at the bottom of the shaft, where the paddler's shaft hand holds the paddle.

Blade. The part of the paddle that is placed in the water. The blade has two sides:

- **Power face.** The side of the paddle blade that presses against the water during a forward stroke.
- **Back face.** The side of the paddle blade that has no pressure against it during a forward stroke. The back face is the opposite side of the power face.

Tip. The very bottom edge of the paddle blade.

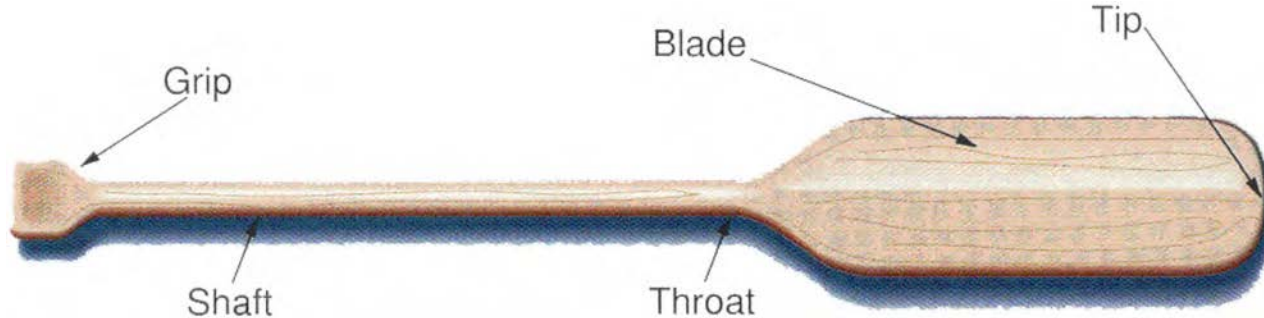



Figure 2 Parts of a Paddle

Note. From *Outdoor Pursuits Series: Canoeing* (p. 21), by L. Guillon, 1994, Champaign, IL: Human Kinetics Publishers. Copyright 1994 by Human Kinetics Publishers.

Sizing a Paddle

When selecting a paddle, it is important to size it correctly. Torso length, canoe seat height and paddling style will determine the proper paddle length.

Most tandem paddlers will require a paddle length between 137 cm and 147 cm. Shorter paddles allow for higher tempo strokes. If the grip hand is above the head during strokes, the paddle is too long.

 Paddle length will differ with individual preference, based on comfort and efficiency.

When choosing a paddle from a group of paddles, there are two ways to size a paddle.

1. Hold the paddle in both hands over your head with one hand on the grip and the other on the shaft, close to the throat. With the paddle rested on the head, the arms should be able to bend comfortably at the elbow in a 90-degree bend.
2. Hold the paddle in one hand and rest the blade on the top of the foot. The grip should come to the chin.

Holding a Paddle

The paddle is held in both hands. One hand will hold the grip (control hand) and the second hand, called the shaft hand, will hold the paddle somewhere between the shaft and the throat of the paddle. If the paddler has shorter arms, the shaft hand will be higher up on the shaft.

Fitting a PFD

Fit is the most important thing when selecting a PFD. A PFD should:

- not be able to be pulled off easily,
- fit snugly, and
- be properly fastened.

 A PFD must always be worn on and near water, and worn as the top layer.



Refer to A-CR-CCP-030/PT-001 *Water Safety Orders* for more information.

DISCUSS SAFETY CONCERNS WHILE CANOEING

Understand Personal Responsibilities

Skill Level. It is the responsibility of the paddler to ensure that they have the proper skill set for paddling. Participants should always advise staff when they feel uncomfortable or unprepared for any aspect of canoe training.

Physical Fitness. Fitness and well-being are an important part of canoeing. Individuals must take responsibility for themselves. Every paddler must make sure they are physically and mentally prepared for paddling. Physical preparedness includes having the endurance to be able to paddle the entire trip. The paddler should not be suffering from a cold or illness, and should not have any physical injuries, such as cramped or sore muscles.

Identify Paddle Signals

The water can be a noisy place. Using a whistle, paddle or gestures are the best ways of getting the attention of other paddlers.

Before heading out on any body of water, it is important to know and understand universal paddle signals. Paddle signals are important in times when there is distance between canoes and it is difficult to hear. Good communication on the water is essential to prevent accidents and ensure swift emergency response.



When receiving a signal, it is important to repeat the signal to the sender and pass the signal on to paddlers behind.

Paddle signals are used to alert the entire group to the direction of travel or to an unexpected situation, such as an overturned canoe.

Stop. Form a horizontal bar with the paddle and move with an up and down motion until remaining paddlers see it. If you are already stationary, stay where you are. Wait for the all clear signal before proceeding.



Figure 3 Stop

Note. From *Basic Kayaking: All the Skills and Gear You Need to Get Started* (p. 83), by J. Rounds, 2005, Mechanicsburg, PA: Stackpole Books. Copyright 2005 by Stackpole Books.



Paddle signals should be given to indicate the direction of travel; not the location of the obstacles.

Help required / emergency. A paddle, helmet or a bright object (not a PFD) are waved in a continuous motion side to side above the head. This means "assist the signaller as quickly as possible".



Figure 4 Emergency

Note. From *Basic Kayaking: All the Skills and Gear You Need to Get Started* (p. 83), by J. Rounds, 2005, Mechanicsburg, PA: Stackpole Books. Copyright 2005 by Stackpole Books.

Raft up. Raise the paddle vertically above the head and move in a circular motion. This signal means "come to me".

All clear. Extend the paddle over the head vertically. Maintain the paddle in the air in order to ensure that all members of the group have seen the signal. This signal is used when it is safe to continue on and indicates that there are no obstructions or danger ahead.



Figure 5 All Clear

Note. From *Basic Kayaking: All the Skills and Gear You Need to Get Started* (p. 83), by J. Rounds, 2005, Mechanicsburg, PA: Stackpole Books. Copyright 2005 by Stackpole Books.

Identify Whistle Signals

A whistle is an effective way to get the attention of other paddlers when visibility is limited and there is a lot of noise. Before heading out on any body of water, it is important to know and understand universal whistle signals. Good communication on the water is essential to prevent accidents and ensure swift emergency response.



Cadets shall be reminded that they will not play with or blow whistles unless they are in an emergency situation.

Universal distress signal. Three whistle blasts indicate that there is an emergency. All action should stop, and action should be taken for the emergency. This signal means assist the signaller as quickly as possible.



Figure 6 Universal Distress Signal

Note. From *Basic Kayaking: All the Skills and Gear You Need to Get Started* (p. 83), by J. Rounds, 2005, Mechanicsburg, PA: Stackpole Books. Copyright 2005 by Stackpole Books.

Move to shore / raft up. Two whistle blasts indicates that there is a need for the group to get together. When two whistle blasts are heard, all personnel will look to the instructor or group leader for instructions and guidance on where to meet up, whether to move to the shore or to raft up at a given point. It should only be used when other forms of communication are not working.

All clear / look at me. When one whistle blast is heard, focus attention on the instructor (look at me). It is used to get the attention of the group. This signal could also mean all clear.



As there are alternative meanings for one and two whistle blasts, it is imperative that the group understands what the signal means for their group. The team / group leader will specify before moving to the water.



Any series of three signals such as three whistle blasts or three horn blasts indicates an emergency. Immediately stop all activity and assist.

IDENTIFY ACTION ON CAPSIZING

Although strong rescue skills are important, preventing rescues by making careful, informed decisions will reduce the chances of capsizing. Anticipating changes in weather, actions of other paddlers and being properly trained will aid in the prevention of accidents.

Discuss Rescue Priorities



The priority of rescue is listed below, but rescuers will only initiate rescue if it is safe to do so without harm to themselves.

When carrying out rescues, it is imperative that every individual involved be aware of the priorities of rescue. The rescue priorities are:

Rescuer. Rescuer safety is priority. The rescuer should not complete any part of the rescue that is beyond the scope of the rescuer's ability. Another casualty will only escalate the emergency.

People. The paddler(s) in the water. Each paddler will make sure they are okay, and that their partner is okay. If they cannot see their partner, they must establish voice contact to confirm that their partner is conscious, is not seriously injured and is preparing to self-rescue.

Canoes. Canoes will be retrieved once all the paddlers in the water are safe.

Equipment. Equipment is the last thing to be retrieved as it is not essential. Clothing and food can be shared if need be.



If involved in a high risk rescue, the rescuer or rescue team should be prepared and trained to perform effectively and efficiently and to follow the procedures.



Cold water and wind will accelerate the loss of body heat. People can become hypothermic very quickly, even in warm weather.

Canoe Over Canoe Assisted Rescue

The canoe over canoe assisted rescue is the universal rescue means.



The figures below depict two solo paddlers completing a canoe over canoe assisted rescue. The procedure is virtually the same as a tandem rescue with only minor adjustments, which are detailed in the numbered procedure. Use the figures as a guideline.



Step 1



Step 2



Step 3



Step 4



Step 5



Step 6



Step 7



Step 8

Figure 7 Canoe Over Canoe Assisted Rescue (Solo Paddlers)

Note. From *Paddle Your Own Canoe* (p. 36), by G. McGuffin & J. McGuffin, 2005, Erin, ON: The Boston Mills Press. Copyright 2005 by The Boston Mills Press.

The procedure to follow in a tandem canoe over canoe assisted rescue is:

1. One paddler will swim to the stern of a rescue canoe, hang on and get as much of the body out of the water as possible.
2. The second paddler will swim to the far end of the capsized canoe.
3. The rescuers will lift up on the capsized canoe as the second paddler pushes down on the opposite end of the capsized canoe to break the suction.
4. The second paddler will then move to the bow of the rescue canoe, hang on and get as much of the body out of the water as possible.

5. Both paddlers will remain in that position until told to move by the rescuers. The rescuers will move the canoe across the gunwales of their canoe. Once it is centred they will flip it over and gently continue to slide it into the water.
6. Maintain communication and when instructed to do so the paddlers will, one at a time, get back into the canoe by one of two ways:
 - a. hook one leg over each canoe and pull up out of the water and climb into the canoe; or
 - b. propel themselves upward by scissor kicking, tucking the shoulder in and rolling into the canoe.
7. Return to the paddling position.

PORTAGING A CANOE

Carrying a Canoe to The Water

Once a canoe is off the vehicle or trailer, it still needs to get to the water. There are several ways to carry a canoe; having one person at each end is a typical way. Hand and arm placement should allow for maximum comfort and provide balance and security against dropping.



It is critical that the canoe is not dragged along the ground. This damages the keel and the bottom of the canoe which may result in holes.

Tandem Hand Carry

For a short distance over relatively flat ground, a canoe can be carried much like a briefcase. This is referred to as the tandem hand carry.

To execute the tandem hand carry:

1. The bow paddler will stand at the bow on the left or right of the canoe.
2. The stern paddler will stand at the stern on the side opposite to the bow paddler.
3. Each paddler will lift the canoe by the handle at their end.



Figure 8 Tandem Hand Carry

Note. From *Outdoor Pursuits Series: Canoeing* (p. 36), by L. Guillon, 1994, Champaign, IL: Human Kinetics Publishers. Copyright 1994 by Human Kinetics Publishers.

Tandem Portage Carry

For longer distances, a canoe can be carried on the shoulders in the tandem portage carry. The canoe is lifted over the head and carried in such a manner that the stern seat rests across the shoulders of the person at the rear and the bow deck rests on one shoulder of the person in front.

To execute the tandem portage carry:

1. Stand up straight, with the legs slightly apart and knees bent. Grasp the gunwale closest to the body, near the bow and stern seats respectively. Place the fingers inside the gunwale and the thumbs outside the gunwale.
2. Keeping the back straight and knees bent, lift the canoe to the thighs in a rocking motion.
3. Reach across the canoe and grasp the far gunwale. The fingers are pointing out and the thumb is in. Reposition the hand from step one so that the fingers are out and the thumb is in.
4. Rocking the canoe again, use your legs to launch and lift the canoe over the head.
5. As the canoe is raised, turn to face the bow and then guide the bow and stern seats onto the shoulders.
6. Rest the weight of the canoe on the shoulders. The bow person will move further forward to improve visibility.
7. To move forward, the bow paddler hand-walks along the gunwale toward the front of the canoe. Balance the canoe's weight side to side and bow to stern.
8. Rest the deck plate on the bow paddler's shoulder.





Figure 9 Tandem Portage Carry Steps 1–8

Note. From *Canoeing: The Essential Skills and Safety* (p. 136), by A. Westwood, 2007, Beachburg, ON: The Heliconia Press. Copyright 2007 by The Heliconia Press.



To lower the canoe, complete the procedure in reverse. It is important to lower the canoe onto the thighs, then onto the ground.

LOADING AND UNLOADING EQUIPMENT FROM A CANOE

Weight Distribution and Stability

Stability is the first consideration when canoeing. Canoes are floats and their stability depends primarily on their shape and the position of the centre of gravity. The more expansive the float over the water and the lower the centre of gravity, the more stable a float becomes.

An empty canoe resting on the water has two centres on the same vertical plane, the centre of gravity and the centre of buoyancy. The canoe is evenly trimmed bow and stern and side to side.



Centre of gravity is the point around which a person's body weight is equally balanced in all directions. The total weight of the person is concentrated at this point. The position of the centre of gravity of an object depends on the shape of the object and the distribution of its weight.

If weight is added to the canoe, such as a heavy pack, the centre of buoyancy changes to stay on the same vertical plane as the centre of gravity.

Loads should not be higher than the gunwales of the canoe and must be evenly distributed over the keel line. Weight should be adjusted so that the canoe is neither bow nor stern heavy.

Canoe Trim

Trim is the way the canoe rides in the water once it has been loaded. It is important to keep the gunwale line parallel to the water surface. In addition, it is crucial that the stern does not ride lower than the bow.

Weight of Paddlers

The weight of the paddlers is often overlooked and must be taken into consideration. Most canoes are rated with a maximum capacity, normally between 500–635 kgs (1100–1400 pounds) with a load range of 135–270 kgs (300–600 pounds). The paddlers' weight must be considered, as this will limit the weight of equipment that can be loaded in the canoe. This weight will also affect the trim of the canoe.



Packs and equipment are tied to the centre thwart using a tether line. This will ensure the equipment is not separated from the canoe. The equipment should be placed in the middle section of the canoe. By trial and error, adjustments may have to be made so that the canoe will be trimmed evenly.

LAUNCHING AND LANDING A CANOE

Identifying a Location

Putting a canoe on water and taking it out of water should be done carefully, smoothly and without damage to the canoe.

The ideal location to launch a canoe is a soft shore or beach where the water is calm. Avoid locations where there are large rocks, stumps and roots, strong wind or large waves.

If you are launching from a shallow beach, launch the canoe at a right angle to the beach and hold it with its stern touching the bottom at the water's edge.

Avoiding Equipment Damage

A canoe should not be pushed, pulled or slid in or out of the water on a beach, bank, or dock. When launching, it is best to lay the canoe in the water from a lift position. It should be raised with the same care when being taken out of the water.

The canoe should be empty when launching. Once the canoe is placed on the water, it can be loaded with equipment while it is floating.

Entering a Canoe

Getting into a canoe for the first time is difficult; with practice, it will become easier. The stern paddler should always hold the canoe steady while the bow paddler enters. Likewise, once the bow paddler has entered the canoe, they will steady the canoe, using their paddle and body, while the stern paddler enters.

The steps for getting into a canoe are:

1. Keep the body low at all times, to lower the centre of gravity; never stand in a canoe.
2. Place the paddle shaft across the gunwales for stability.

3. Grasp both gunwales and step into the canoe over the centreline.
4. Step along the centreline and slide the hands and paddle along the gunwales to move to the seat.

Launching a Canoe at a Shoreline



Launching and landing a canoe in waves is inadvisable. Wait for a lull and keep the canoe at a right angle to the water.

If the canoe swamps at any time, avoid getting between the canoe and the shore. A canoe full of water weighs approximately 1 ton (1 000 kg) and can seriously injure a paddler.

There are several ways to launch a canoe from shore. The most common is the bow first launch:

Procedure for the bow first launch:

1. Put on a PFD and have paddles in the canoe or on the shoreline. Set the canoe at a right angle to the shore.
2. Place the spare paddle and stern paddle in the centre of the canoe. Have the stern paddler hold the canoe while the bow paddler walks up the length of the canoe keeping their weight low and balanced over the centreline. Stability is maintained by keeping the paddle shaft across the gunwales.
3. Have the bow paddler sit or kneel and place the paddle in the ready position as detailed in Figure 10. The stern paddler will hold the paddle shaft across the gunwales for stability.
4. Have the stern paddler slide their paddle forward along the gunwales, continuing to hold both paddle shaft and gunwales while keeping their weight low and balanced over the centreline. The blade is positioned on the side opposite to the bow paddlers' paddling side.
5. Once the stern paddler is kneeling and in the ready position, move the canoe away from the shore.



Figure 10 Bow First Launch

Note. From *Paddle Your Own Canoe* (p. 36), by G. McGuffin & J. McGuffin, 2005, Erin, ON: The Boston Mills Press. Copyright 2005 by The Boston Mills Press.



On windy days, face the canoe directly into the wind when launching.

Landing a Canoe at a Shoreline

When a suitable location to exit the canoe is found, the following procedure shall be followed:

1. Bring the canoe into landing without running up on shore.
2. Have the bow paddler exit first to steady the canoe for the stern paddler.
3. Have the stern paddler move forward, keeping their weight low in the canoe.
4. Have the stern paddler exit at the bow.

Exiting a Canoe

To exit the canoe, reverse the entry procedures:

1. Bring the canoe into the landing slowly and carefully.
2. Keep the body low at all times, lowering the centre of gravity.
3. Place the paddle shaft across the gunwales for stability.
4. Grasp both gunwales and the paddle shaft, and move to the bow of the canoe.
5. Step out of the canoe, keeping weight low.

EXECUTE CANOE STROKES



Kneeling is the position of choice for paddling because it provides increased canoe stability. When a person kneels, their centre of gravity is lowered. To give sore knees a break, a paddler can sit on the seat.



There are four phases of a stroke that help ensure the transition between each stroke is natural and smooth.

Catch. The beginning of the stroke where the blade is inserted into the water.

Power. The movement of the paddle through the water by rotating the torso to transmit power to the blade. When paddling, it is important to use the muscles of the torso, which have more strength and endurance than the arm muscles.

Exit. When the paddle leaves the water.

Recovery. When the paddle is returned to the catch position. This is completed by feathering the blade (keeping it flat and just above the water surface) to minimize wind resistance.



The stern paddler will control the direction of the canoe using corrective strokes where applicable. The bow paddler will complete mostly power strokes when canoeing, unless the stern paddler requires assistance with corrective strokes.

Power Stroke

The power stroke is used to move the canoe forward. It is the foundation stroke on which most other strokes are built. The power stroke is made close to the side of the canoe and parallel to the keel, with the shaft of the paddle moving in a vertical or near-vertical plane. To complete the power stroke:

1. Rotate the torso forward toward the bow to engage the muscles for the stroke.
2. Place the blade deep into the water with as little splash as possible.
3. Unwind the torso while pulling on the shaft hand (lower hand) and pushing with the control hand (upper hand).
4. Power the stroke through the water until the blade of the paddle is in line with the knee.
5. Lift the paddle out of the water by slicing it out to the side.
6. Recover the stroke with the blade clear and flat across the water (to reduce wind resistance) and complete another stroke.

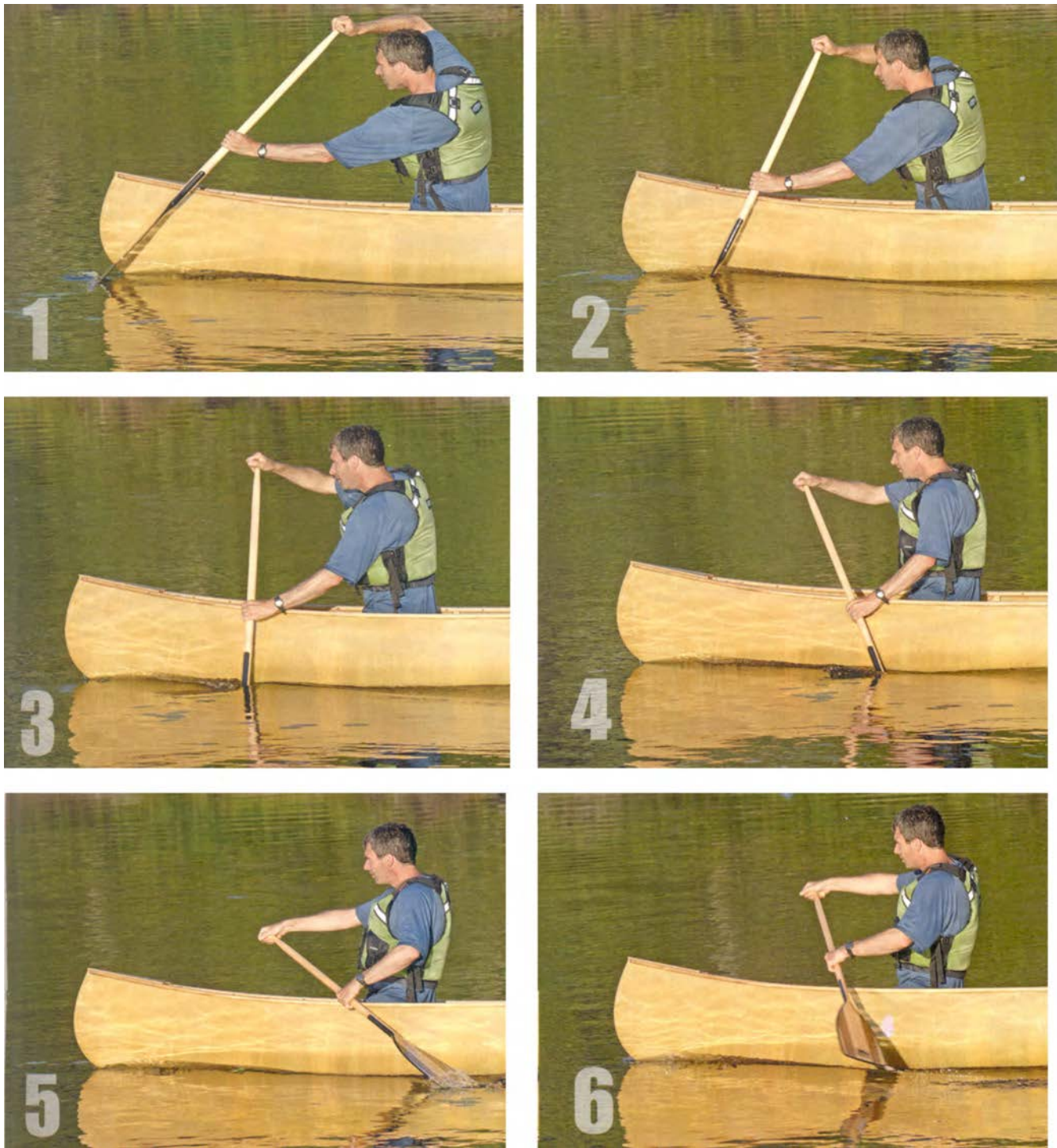

Figure 11 Power Stroke

Note. From *Canoeing: The Essential Skills and Safety* (p. 71), by A. Westwood, 2007, Beachburg, ON: The Heliconia Press. Copyright 2007 by The Heliconia Press.

J-Stroke



Watch for ruddering as the cadets' practice the J-stroke. Ruddering is when the stern paddler places their paddle in the water behind the hip and manoeuvres it back and forth to turn the canoe. This will create drag and slow the forward momentum of the canoe.

The J-stroke is a version of the power stroke used as a corrective stroke by the stern paddler to help keep the canoe travelling in a straight line. When applied with force, it can be used to turn the canoe to the stern paddler's side (the side they are paddling on). To complete the J-stroke:

1. Complete the first four steps of the power stroke, ending with the control hand above the gunwale and the shaft hand at the hip.
2. Twist the control hand thumb forward and down while pulling the shaft hand inward, forming a "J".
3. Recover to complete another stroke.

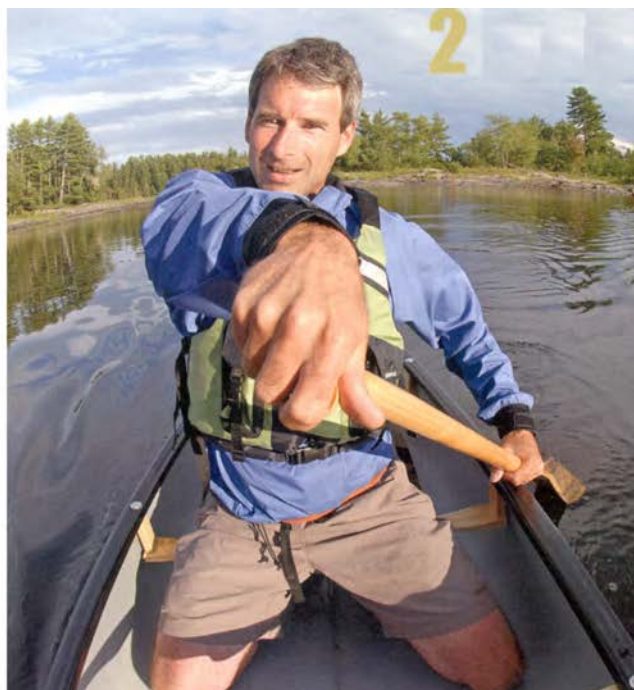

Figure 12 J-Stroke

*Note. From *Canoeing: The Essential Skills and Safety* (p. 74 and p. 75), by A. Westwood, 2007, Beachburg, ON: The Heliconia Press. Copyright 2007 by The Heliconia Press.*

Forward Sweep

The purpose of the forward sweep is to turn the canoe away from the canoeist's paddling side. It is a wide sweep of the paddle, using the power face of the blade. There are many occasions when this stroke would be used, such as:

- swinging the canoe for pivot turns or partial turns;
- manoeuvring the canoe around obstacles;

- following along the bends of streams or rivers;
- making sudden changes of direction in paddling;
- aiding in holding a straight course in crosswinds; and
- incorporating with other strokes as necessary to control the canoe.



Reverse sweeps use the back face of the blade and are the opposite of forward sweeps. Both sweeps have many of the same functions.

As the bow paddler, to complete the forward sweep:

1. Rotate the torso and bend forward slightly while immersing the blade of the paddle almost horizontally by the bow of the canoe.
2. Push the shaft hand out slightly from the waist while swinging in a 90-degree arc until the arm extends out from the hip (the paddle should be at a right angle to the side of the canoe).
3. Recover to complete another stroke.

As the stern paddler, to complete the forward sweep:

1. Lean back slightly as the upper body rotates while extending and immersing the paddle almost horizontally at a right angle to the side of the canoe at the hip, keeping the lower hand at waist height with the thumb pointing up.
2. Push out slightly with the shaft hand while swinging in a 90-degree arc (the paddle should be almost touching the stern).
3. Recover to complete another stroke.



When the bow paddler is completing a forward sweep, the stroke should never move past the paddler's body. Any further movement will result in drag and loss of momentum.



Step 1



Step 2



Step 3

Figure 13 Forward Sweep

Note. From *Paddle Your Own Canoe* (p. 51), by G. McGuffin & J. McGuffin, 2005, Erin, ON: The Boston Mills Press. Copyright 2005 by The Boston Mills Press.

Draw

The purpose of the draw is to turn the canoe or to move it sideways. The draw stroke can be completed by both the bow and stern paddler. To complete the draw stroke:

1. Rotate the torso and extend the arms fully to position the paddle at the side of the canoe, adjacent to the knee.
2. Reach across the canoe with the control hand and place the paddle vertically into the water.
3. Plant the blade deeply in the water and pull the power face toward the body.
4. Twist the control hand thumb away from the body and rotate the blade 90 degrees (before the blade hits the canoe).

5. Bring the paddle back to the beginning position by slicing it through the water.
6. Twist the blade back into the original position to complete another stroke.



Figure 14 Draw

Note. From *Canoeing: The Essential Skills and Safety* (p. 95), by A. Westwood, 2007, Beachburg, ON: The Heliconia Press. Copyright 2007 by The Heliconia Press.

Pry

The pry is a powerful, deep-water stroke that can be applied by the bow or the stern paddler to move the canoe away from the paddler's side. To complete the pry stroke:

1. Place the paddle vertically against the gunwale adjacent to the knee with both hands above the gunwale.
2. Pull inward with the control hand to force the paddle away from the canoe.
3. Rotate the blade 90 degrees by twisting the thumb of the control hand away from the body and slicing the blade back to the beginning point.

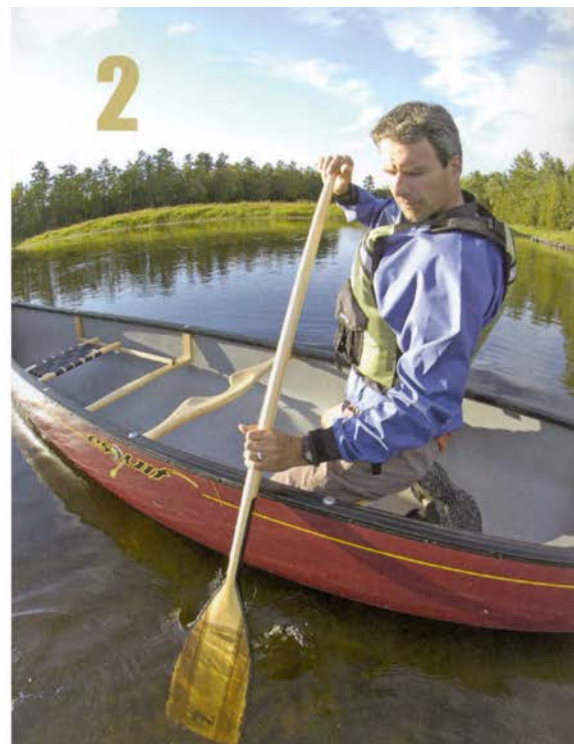



Figure 15 Pry

Note. From *Canoeing: The Essential Skills and Safety* (p. 96), by A. Westwood, 2007, Beachburg, ON: The Heliconia Press. Copyright 2007 by The Heliconia Press.



If the bow paddler completes a pry and the stern paddler completes a draw, the canoe will move sideways. This combination of strokes is useful if trying to move a canoe parallel to a dock or when rafting up.

Low Brace

The low brace will assist in righting a canoe from capsizing or if it begins to tip. This stroke will also help a paddler rely on the paddle to steady the canoe as well as lean into turns. It can also be used by the stern paddler to steady the canoe when the bow paddler is initiating a turn. To complete a low brace:

1. Twist the upper body to face the water, with the paddle out at a 90-degree angle to the canoe.
2. Smack the water with the flat backside of the paddle to provide support to balance the body in the canoe.
3. Begin to get the knees level in the canoe by dropping the head towards the shaft of the paddle.
4. Assume a stable posture with the head centred inside the canoe once the canoe has levelled.



Figure 16 Low Brace

Note. From *Canoeing: The Essential Skills and Safety* (p. 98 and p. 99), by A. Westwood, 2007, Beachburg, ON: The Heliconia Press. Copyright 2007 by The Heliconia Press.

Jam

The jam stroke will stop a canoe's forward momentum quickly when applied. To execute the jam, the paddler will shove the paddle into the water at a right angle to the canoe in a vertical position.

Backpaddle

To go backward, the bow paddler can complete a reverse power stroke. If necessary, the stern paddler can do a pry in the beginning to steady the canoe. To backpaddle:

1. Lean slightly back, rotate the shoulders back and place the blade of the paddle vertically in the water at the rear of the canoe up to the throat.
2. Unwind the body while pushing forward with the shaft hand and pulling with the control hand.

3. Continue with the stroke until the shoulders are square with the gunwales.
4. Lift the blade out of the water and recover to complete another stroke.



Figure 17 Backpaddle

Note. From *Canoeing: The Essential Skills and Safety* (p. 98–99), by A. Westwood, 2007, Beachburg, ON: The Heliconia Press. Copyright 2007 by The Heliconia Press.



If both paddlers are backpaddling, the canoe will turn away from the bow paddler's side.

ACTIVITY

Time: 270 min

OBJECTIVE

The objective of this activity is to have the cadets, in teams of no more than six, paddle a tandem canoe on flatwater, for 15–20 km, during an expedition.

RESOURCES

- Fully equipped tandem canoe (one per two cadets),
- Personal canoe equipment (one per cadet),
- Group canoe equipment (one per team), and
- Water carrier (one per cadet).

ACTIVITY LAYOUT

Designate a flatwater canoe route, IAW A-CR-CCP-030/PT-001, *Water Safety Orders*.

ACTIVITY INSTRUCTIONS

1. Conduct a briefing, to include an explanation of:
 - a. the objectives and importance of the activity;
 - b. the resources that may be required to perform the activity; and
 - c. any safety guidelines that must be followed while performing the activity.
2. Have cadets size and fit paddles and PFDs.
3. Place cadets in canoe partners.
4. Assign a bow and stern paddler (groups will be required to switch at the half-way point of the route).
5. Have cadets outfit their canoes with safety equipment.
6. Have cadets, in teams of no more than six, paddle a tandem canoe on flatwater, following the designated route for a distance of 15–20 km during an expedition to practice:
 - a. launching and landing the canoe;
 - b. turning the canoe;
 - c. pivoting the canoe;
 - d. moving the canoe laterally;
 - e. paddling in a straight line; and
 - f. stopping the canoe.
7. Upon arrival at the end point, have the cadets store / return all equipment.

8. Conduct a debriefing by asking the cadets:
 - a. how they felt about the activity;
 - b. how they felt their team worked together;
 - c. what portion of the activity challenged them the most;
 - d. how their teammates assisted them when they were challenged;
 - e. if there are any specific examples of when their team bonded;
 - f. how the team made decisions;
 - g. whether or not all team members ideas / suggestions were considered; and
 - h. what they would do as a leader of this type of activity to ensure their subordinates enjoyed the experience.

SAFETY

- Cadets must wear their PFDs at all times.
- Each team will be led by the assigned team leader.
- All canoes in a team must travel together—there can be no more than two canoe lengths between team canoes.
- Team Instructor(s) (TIs) must be in sight / sound of the team at all times.
- Teams will travel separately along the canoe route.
- There will be a minimum of 500 m between teams at all times.
- Cadets must carry at least 1 L of water.
- Water re-supply points will be located along the route.
- Meals will be provided at a pre-determined location(s) and detailed in the route instructions.

CONFIRMATION OF TEACHING POINT 1

The cadets' participation in paddling a canoe will serve as the confirmation of this TP.

END OF LESSON CONFIRMATION

The cadets' participation in the expedition will serve as the confirmation of this lesson.

CONCLUSION

HOMEWORK / READING / PRACTICE

Nil.

METHOD OF EVALUATION

This lesson is assessed IAW A-CR-CCP-704/PG-001, *Gold Star Qualification Standard and Plan*, Chapter 3, Annex B, 426 PC.

CLOSING STATEMENT

Canoeing is a fun and challenging mode of travel that can be used during expedition training. Being able to efficiently manoeuvre a canoe while on expedition provides a great sense of freedom and accomplishment. Canoe strokes only improve with practice, it is important to make an effort to continue the development of the skills.

INSTRUCTOR NOTES / REMARKS

Expedition centres are required to select two dynamic modes of travel from EO M426.02a (Paddle a Canoe), EO M426.02b (Ride a Mountain Bike), EO M426.02c (Hike Along a Route), EO M426.02d (Snowshoe Along a Route) and EO M426.02e (Ski Along a Route) to incorporate into the expedition training.

This EO has been allocated nine periods in the overall course period allocation. Each expedition centre may adjust this allocation to reflect the choice of activities, facilities and available resources in the expedition centre.

Upon arrival at the expedition centre, cadets will be divided into teams. Cadets will be given an opportunity to navigate and lead peers. These teams will remain the same for the duration of the expedition.

IAW A-CR-CCP-030/PT-001, *Water Safety Orders*:

1. a fully equipped tandem canoe is described as having the following items:
 - a. bailer,
 - b. buoyant heaving line or throw bag,
 - c. sound signalling device,
 - d. spare paddle, and
 - e. painter lines;
2. the following personal canoe equipment is required when paddling a canoe:
 - a. PFD, and
 - b. paddle; and
3. the following group canoe equipment is required when paddling a canoe:
 - a. topographical or river map of area as required,
 - b. compass,
 - c. GPS receiver,
 - d. first aid kit,
 - e. communication device (eg, cellular phone or hand-held radio), and
 - f. canoe repair kit.

The intensity level of the activity shall follow the progression matrix outlined in A-CR-CCP-951/PT-002, *Royal Canadian Army Cadets Adventure Training Safety Standards*.

IAW A-CR-CCP-951/PT-002, *Royal Canadian Army Cadets Adventure Training Safety Standards*, there are pre-training requirements for canoeing. Assess the level of pre-training required and plan time into the expedition as necessary.

Ensure that each cadet has an ample supply of drinking water when canoeing.

REFERENCES

A1-010 A-CR-CCP-030/PT-001 Director Cadets 3. (2005). *Water safety orders*. Ottawa, ON: Department of National Defence.

A2-001 A-CR-CCP-951/PT-002 Director Cadets 4. (2006). *Royal Canadian Army Cadets adventure training safety standards*. Ottawa, ON: Department of National Defence.

C0-025 ISBN 1-895465-33-8 Gifford, D. (Ed.) (2000). *Canoeing instructor's resource manual*. Merrickville, ON: Canadian Recreational Canoeing Association.

C2-076 ISBN 0-87322-443-4 Gullion, L. (1994). *Outdoor pursuits series: Canoeing*. Champaign, IL: Human Kinetics Publishers.

C2-077 ISBN 1-55013-654-2 Mason, B. (1995). *Path of the paddle: An illustrated guide to the art of canoeing*. Toronto, ON: Key Porter Books Limited.

C2-078 ISBN 1-55013-079-X Mason, B. (1988). *Song of the paddle: An illustrated guide to wilderness camping*. Toronto, ON: Key Porter Books Limited.

C2-106 ISBN 0-900082-04-6 Rowe, R. (1997). *Canoeing handbook* (2nd ed.). Guildford, UK: Biddles Limited.

C2-112 ISBN 1-55046377-2 McGuffin, G., & McGuffin, J. (2005). *Paddle your own canoe: An illustrated guide to the art of canoeing*. Erin, ON: Boston Mills Press.



ROYAL CANADIAN ARMY CADETS
GOLD STAR
INSTRUCTIONAL GUIDE



SECTION 3

EO M426.02b – RIDE A MOUNTAIN BIKE

Total Time: 270 min

PREPARATION

PRE-LESSON INSTRUCTIONS

Resources needed for the delivery of this lesson are listed in the lesson specification located in A-CR-CCP-704/PG-001, *Gold Star Qualification Standard and Plan*, Chapter 4. Specific uses for said resources are identified throughout the instructional guide within the TP for which they are required.

Review the lesson content and become familiar with the material prior to delivering the lesson.

Every cadet must have a water carrier prior to the start of this lesson.

All mountain bikes and helmets being used should be organized by size prior to the start of this lesson.

Have mountain bike pumps and mountain bike repair kits available to complete the pre-ride check.

Have cleaning materials available to complete the post-ride check.

Review the terrain and trail features of the mountain bike route. Be aware of challenging areas where cadets may require additional supervision.

PRE-LESSON ASSIGNMENT

Nil.

APPROACH

The experiential approach was chosen for this activity as it allows the cadet to acquire new knowledge and skills through a direct experience. The cadet experiences mountain biking on familiarization / intermediate trails during an expedition and defines the experience on a personal level. The cadet will be given the opportunity to reflect on and examine what they saw, felt and thought while mountain biking and consider how it relates to what they already learned and experienced as well as how it will relate to future experiences.

INTRODUCTION

REVIEW

Nil.

OBJECTIVES

By the end of this lesson the cadet shall have ridden a mountain bike on familiarization / intermediate trails during an expedition.

IMPORTANCE

It is important for cadets to be able to ride a mountain bike on familiarization / intermediate trails during an expedition. Cadets will be required to work as a member of an expedition team to travel a significant distance during the expedition. Being able to perform basic mountain bike skills will assist them in keeping up with their team. Mountain biking over more difficult terrain features will provide cadets the opportunity to put into practice new mountain bike skills while further developing their basic mountain bike skills in an environment that challenges them both physically and mentally.

Teaching Point 1**Ride a mountain bike on familiarization / intermediate trails during an expedition.**

Time: 270 min

Method: Experiential Learning

BACKGROUND KNOWLEDGE

The TP for this lesson will occur during the mountain bike portion of the expedition. In most situations cadets will have already received instruction and been provided the opportunity to practice basic mountain bike skills during the Silver Star Expedition / at the CSTC. The requirement to review skills will be based on the experience level of the cadets and the expedition training centre. Should a review be required, it is suggested that it is completed along the route as the need arises.

SELECTING AND ADJUSTING A MOUNTAIN BIKE

Since the first introduction of the mountain bike in the mid- to late-1970s, the design of bikes has evolved. The quest for improved products has led to continued improvements and advancements in materials being used to construct the bikes, as well as the overall design of the bikes themselves. With the introduction of new bikes each year by key manufacturers the use of stronger and lighter materials, and cutting edge designs compete to maximize speed, power and strength.

While it is important to have a well-designed mountain bike, if the bike chosen does not fit the mountain biker the excellence in design will be lost. Having a properly-fitted mountain bike is important for riding efficiency and power, as well as safety. When a mountain bike does not fit the mountain biker properly, injuries are more likely.

Selecting a Helmet

A properly-fitted helmet should:

- fit level and square on the head;
- cover the front of the forehead;
- sit snug on the head, without fastening the chin strap;
- not slip when the head moves; and
- have straps adjusted to meet just below the ear and fastened tightly.



Incorrect



Incorrect



Correct

Figure 1 Proper Fit of a Helmet

Note. From *Cycling Skills: Cycling Safety for Teen and Adult Cyclists* by Ministry of Transportation Ontario, 2005, Copyright 2005 by Government of Ontario. Retrieved October 5, 2007, from <http://www.mto.gov.on.ca/English/pubs/cycling/cyclingskills.htm>



Helmet sizes vary from extra small to extra large. It is important to try on a variety of sizes to make sure the fit is correct.

Adjusting the Helmet

A helmet will not necessarily fit without making some minor adjustments. The following are some basic adjustments that can be made to ensure the helmet will protect the mountain biker in an accident:

1. Adjust removable pads, if required, to make the fit firm and comfortable.
2. Centre the chin clip so it is just under the chin and so the strap is even on both sides. This is done by pulling the strap from one side to another through the underside of the helmet.
3. Adjust the side straps by pulling or pushing them through the sliders. The slider should sit just below the ears, forming a 'V'.
4. Use the rear adjuster (if there is one) by sliding the mechanism to make it bigger or smaller.
5. Buckle the chin clip and ensure no more than two fingers can fit under it.

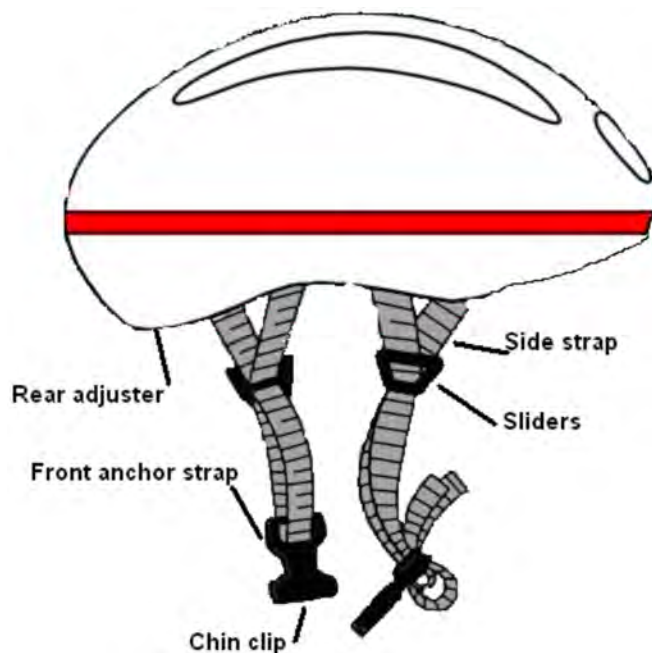

Figure 2 Parts of a Helmet

Note. From *CPSC Issues New Safety Standard for Bike Helmets* by U.S. Consumer Product Safety Commission. Retrieved October 30, 2007, from <http://www.cpsc.gov/cpsc/pub/prerel/prhtml98/98062.html>

Selecting a Mountain Bike

While some manufacturers size their mountain bikes by labelling them as small, medium, large and extra large, in most cases mountain bike size is given in inches and is based on leg length. The frame size is determined by measuring the distance from where the crank attaches to the mountain bike to the intersection of the seat tube and the top tube.



Figure 3 Sizing Measurements

Note. From *Bike Sizing Guide* by Dynamic Bicycles, 2005 , Copyright 2005 from Dynamic Bicycles, Inc. Retrieved October 31, 2007, from <http://www.dynamicbicycles.com/bikes/sizing.php>

The following steps should be followed when sizing a mountain bike:

1. **Size by eye.** The initial step in sizing a mountain bike is to select a mountain bike with a frame size that coincides with the height of the mountain biker.
2. **Stand-over test.** The next step is to straddle the mountain bike. There should be minimum 5-cm (2-inch) clearance between the top tube and the crotch when the mountain biker is straddling the mountain bike.
3. **Saddle adjustment.** Standing next to the mountain bike, the mountain biker will adjust the saddle height to just above their hip by opening the seat post release, raising or lowering the saddle, and closing the release. The mountain biker will then sit on the saddle, and place their left foot on the pedal with the ball of the foot over the centre of the pedal. The left leg should be almost perpendicular, without the knee locking.

COMPLETE A PRE-RIDE BIKE CHECK

Mountain biking is incredibly hard on the mountain bikes and equipment. Before the start of a ride it is important to run through a pre-ride check to ensure the mountain bike is in the best possible condition for riding. It may seem redundant to do this before every ride, especially when a post-ride check was completed; however, it only takes one broken cable or one flat tire to ruin a ride.

The ABC Quick Check is an easy way to remember what parts of the mountain bike should be checked during a pre-ride check. The check is a series of questions that the mountain biker must ask themselves, in relation to five areas of the mountain bike. The ABC Quick Check should be practiced so that it can be done quickly and efficiently. The mountain biker will correct any minor issues at the time of the pre-ride check; any major issues, or those that require a mountain bike tool, will have to be brought to the attention of the ride leader.

Air

The first step in the ABC Quick Check begins by focusing the mountain biker's attention on the wheels and tires of the mountain bike.

Do the tires have enough air?

This can be checked using a bicycle pump that has a built-in tire pressure gauge. The tire pressure for mountain bike tires should be between 35 pounds per square inch (psi) (240 kpa) and 65 psi (448 kpa).



When pumping the tires, aim to ensure the tire pressure is between 45–50 psi (310–345 kpa). This will allow for a variety of trail conditions.



Different trail conditions require different tire pressures. Harder surfaces are easier to ride with harder tires; (50–65 psi [345–448 kpa]), and conversely, softer surfaces are easier with softer tires; (35–40 psi [240–275 kpa]).

Is there any excessive wear on the tread or any cuts on the side walls of the tires?

Any loose or engrained mud or debris that is lodged in the tread should be removed. This will help eliminate the possibility of sharp objects working their way through the tire casing into the inner tube, causing a flat.

Brakes

Next the mountain biker will inspect the front and rear brakes of the mountain bike. It is important to spend time inspecting the brake levers, as well as the actual braking mechanism.

Do the brake levers work effectively?

There should be at least two finger's distance between each brake lever and the handlebar when pulled. It should require little effort to engage the brake lever. If it is hard to pull then the brake cables require adjustment.

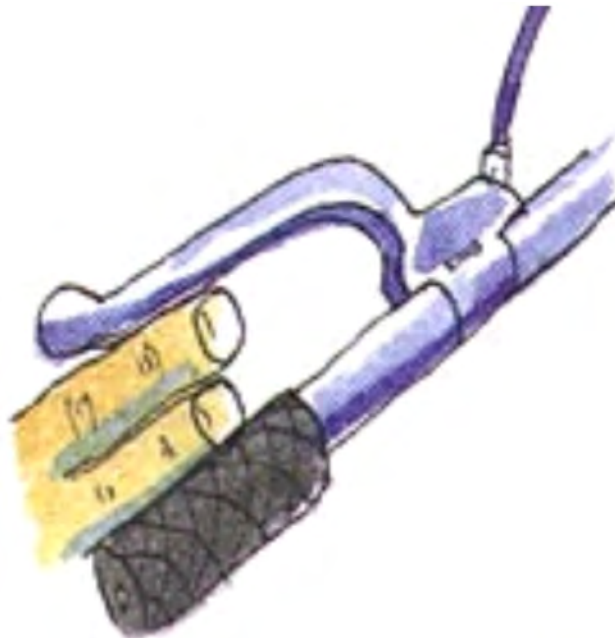

Figure 4 Brake Lever Positioning

Note. From *Young Cyclists Guide* by Ministry of Transportation Ontario, 2005, Copyright 2005 by Government of Ontario. Retrieved November 5, 2007, from <http://www.mto.gov.on.ca/English/pubs/cycling/youngcyclists.htm>

Do the brakes function as they are supposed to?

The front and rear brakes should be checked independently. The mountain biker should stand beside the mountain bike and push it forward by the handlebars. When the front brake lever is pulled, on its own, the rear wheel should lift up as the front wheel locks. When the rear brake lever is pulled, on its own, the rear wheel should lock and slide across the ground.

Chain and Crank

The chain and crank are what make the mountain bike move forward. If they are not in good working order the mountain bike will be difficult to manoeuvre and will most likely not get very far.

Is the chain on and lubricated?

The chain should be able to move freely around the front and rear sprockets when the pedals are moved with no visible signs of bends or kinks. There should be no evidence of rust on the chain. If there is, an application of lubricant should work out the rust.



Figure 5 Lubricating the Chain

Note. From *Young Cyclists Guide* by Ministry of Transportation Ontario, 2005, Copyright 2005 by Government of Ontario. Retrieved November 5, 2007, from <http://www.mto.gov.on.ca/English/pubs/cycling/youngcyclists.htm>

Do the pedals spin freely?

The mountain biker should lift up the rear wheel and move the pedals with one hand to check the functionality.

Quick Release

Quick release levers are located on the front and rear wheels, as well as the seat post.

Are the wheel quick releases working?

Open and close both the front and rear tire quick release levers. They should be easy to open and close. If not, lubricant should be applied. Ensure they are fully tightened following the check and that the lever is flush with the fork of the mountain bike.



Figure 6 Quick Release Incorrect Position—Example 1

Note. From *Young Cyclists Guide* by Ministry of Transportation Ontario, 2005, Copyright 2005 by Government of Ontario. Retrieved November 5, 2007, from <http://www.mto.gov.on.ca/English/pubs/cycling/youngcyclists.htm>



Figure 7 Quick Release Incorrect Position—Example 2

Note. From *Young Cyclists Guide* by Ministry of Transportation Ontario, 2005, Copyright 2005 by Government of Ontario. Retrieved November 5, 2007, from <http://www.mto.gov.on.ca/English/pubs/cycling/youngcyclists.htm>

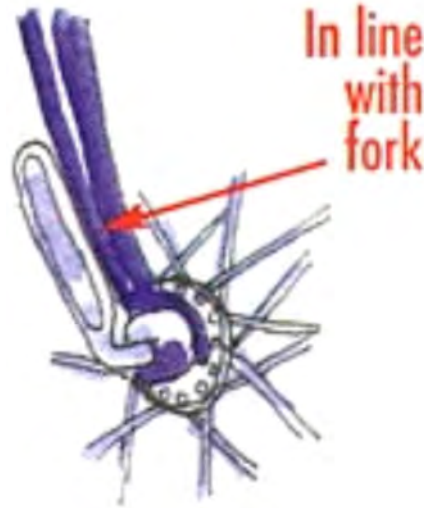

Figure 8 Quick Release Correct Position

Note. From *Young Cyclists Guide* by Ministry of Transportation Ontario, 2005, Copyright 2005 by Government of Ontario. Retrieved November 5, 2007, from <http://www.mto.gov.on.ca/English/pubs/cycling/youngcyclists.htm>

Is the saddle quick release working?

Open and close the lever to ensure that it is in good working order. It should be easy to open and close. If not, lubricant should be applied. When closed the lever should be flush with the seat post, pointing towards the back of the mountain bike.

Final Check

Finally, the mountain biker should complete a final check of their mountain bike. The mountain bike should be lifted five to seven centimetres (two to three inches) off the ground and then dropped in a controlled manner. When it drops the mountain biker should be listening for sounds associated with loose parts (clings / clangs / pings).

IDENTIFY SAFETY PERCAUTIONS WHICH MUST BE ADHERED TO WHEN MOUNTAIN BIKING

Keeping safe on mountain bikes is part common sense and part informed risk-taking, together with a healthy dose of good judgment. Preventing injuries is far easier than seeking medical attention after the fact. Following basic trail and road safety rules will ensure that the ride is safe, not only for the mountain biker but for all trail users.

| | |
|--|---|
| | Investigate the specific rules and regulations associated with mountain bike safety for your province or territory to pass along to cadets in conjunction with the material presented in this TP. |
|--|---|

Each province and territory has specific rules and regulations in relation to mountain bike safety. Bikes are the smallest vehicles on the road which makes it very important for mountain bikers to be as visible as possible to other road users at all times.

Rules of the Road

Each province has specific rules of the road which form laws within the province. In Ontario, these rules are stated in the *Highway Traffic Act* (HTA).

Some important rules that cyclists should know are:

- A mountain bike is a vehicle and as a cyclist, the same rights and responsibilities apply as to other road users.
- Stop at red lights and stop signs, and travel in the designated direction on one-way streets.
- A mountain bike is a slow vehicle and must travel as far to the right as possible, except when preparing for a left turn or passing. Ride out from the curb far enough to maintain a straight-line path.
- Never compromise safety for the convenience of a motorist; use any part of a lane if the safety of the mountain biker requires it.
- Stop for pedestrians at crosswalks, and walk the mountain bike across crosswalks.
- Stop for school buses when the upper red lights are flashing and the stop arm is out.
- Stop 2 m (6.5 feet) behind streetcar doors and wait until the passengers have boarded or reached the curb.
- Do not attach a mountain bike to a vehicle to hitch a ride.
- Do not ride on expressways, freeways or on roads where "No Bicycle" signs are posted.
- Mountain bikers must correctly identify themselves when stopped by the police for breaking traffic laws.

Signalling

When riding a mountain bike on the road it is important to ensure that drivers of motor vehicles are aware of the biker's direction of travel at all times. Making a surprise turn in front of a car is dangerous to both the mountain biker and the driver. Demonstrating proper hand signals will help to eliminate some of the risk associated with riding a mountain bike on roadways.



Figure 9 Hand Signals

Note. From *Young Cyclists Guide* by Ministry of Transportation Ontario, 2005, Copyright 2005 by Government of Ontario. Retrieved October 5, 2007, from <http://www.mto.gov.on.ca/English/pubs/cycling/youngcyclists.htm>

Riding Discipline

Whether riding a mountain bike on the side streets of town or on a double track in a conservation area, demonstrating awareness for the other mountain bikers will ensure that everyone has a safe ride. Ride discipline is a multi-faceted term that coincides with a variety of aspects of mountain biking, from personal and group organization, to stopping and starting procedures.

Riding in a group is one of the safest ways to ride. It is important to remember that each mountain biker is responsible for the person following them. Always have visual contact with the mountain biker behind. If, when looking back, the other mountain biker is not visible, stop and wait for a moment. If the mountain biker does not appear in a reasonable amount of time, call a halt to the mountain bikers ahead, and go back and look for the other mountain biker.

There are a few safety tips to keep in mind when travelling in groups:

- Ride in single file on roads and trails as much as possible.
- The lead mountain biker must communicate turns, obstacles and changes in momentum to the remainder of the group through hand signals and voice commands.
- Keep at least 1 m (3.2 feet) between mountain bikers in the group on flat ground.
- When descending hills, keep at least 3 m (9.8 feet) between mountain bikers.
- When ascending hills, stay in single file and keep to the right.
- When stopping, ensure the entire group is completely off the trail or road.
- When stopped, all group members should get off their mountain bikes, turn mountain bikes so they are facing the road, close in ranks and stand to the left of their mountain bikes.
- If travelling on roads in a large group, break into smaller groups of about 10 with at least 1 km (0.62 miles) between each group to allow traffic to pass.
- Road crossings should be completed with the group lining up parallel to the other side of the road and then, in line, walking their mountain bikes across.

PERFORM MOUNTAIN BIKE SKILLS

Braking

Braking is used not only for stopping, but for slowing down and controlling the mountain bike on roads and trails. It is important for a mountain biker to be able to judge the amount of pressure to use and when to brake for various situations while on the roads and trails. This knowledge will ensure personal safety as well as the safety of other mountain bikers and trail users.

The left-hand brake lever controls the front brake while the right-hand lever controls the rear. Most braking is completed by the right hand, rear brakes, with the left adding assistance as required.

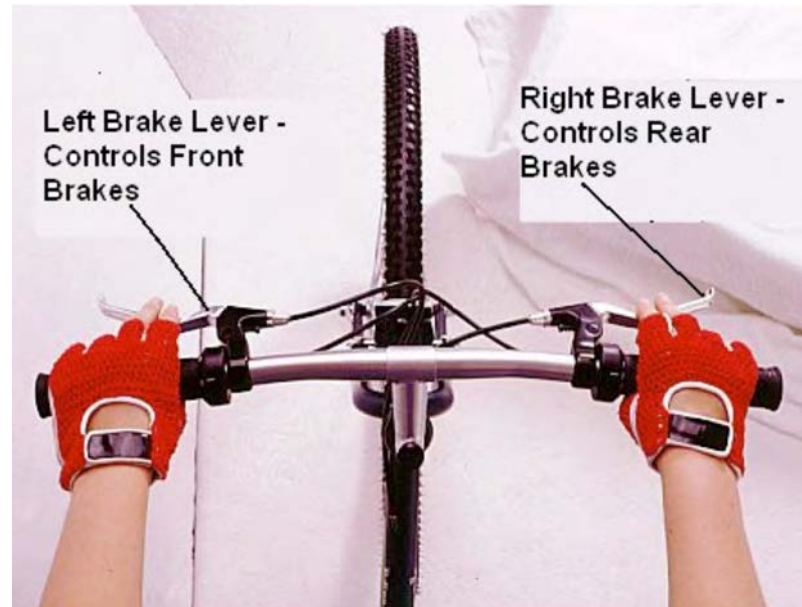

Figure 10 Braking Hand Position

Note. From *Sports, Games, Recreation, Mountain Biking* by DK Images, 2007, Copyright 2007 by DK Limited. Retrieved November 5, 2007, from <http://www.dkimages.com/discover/Home/Sports-Games-Recreation/Outdoor-Adventure/Mountain-Biking/index.html>



Riders should be cautioned against using the left brake lever by itself. While this will stop the mountain bike, the forward momentum may cause the mountain biker to continue over the front of the handlebars and mountain bike, resulting in a possible injury.

Shifting Gears

Terrain can change quickly when mountain biking. The ability to time a perfect gear shift is a crucial mountain bike technique to master. Smooth shifting makes the difference between a smooth, easy ride and a rough, hard ride. Gear components are equipped with pre-set gears and ramps built into the chainrings and cogs to help the chain move smoothly from one to another. The mountain biker has to shift to the correct gear at the appropriate time.

Gearing adjusts the pedalling load so the mountain biker can adapt to changes in terrain. A gear is described by the number of teeth on the sprocket that is being used.

Gear Ratio

The gear ratio is the relationship between the front chainring and the rear cassette being used. If the chainring and the cog have the same number of teeth the rear wheel would turn once for every pedal stroke and the ratio would be 1 : 1. If the chainring has more teeth than the cog, for example, 34 versus 17, then the ratio would be 2 : 1 and the rear wheel would revolve twice for every pedal stroke. There can also be negative gear ratios where the rear cog has more teeth than the smallest chainring, which makes the rear wheel turn slower than the pedal stroke.



Front Chainset



Rear Cassette

Figure 11 Front Chainset and Rear Cassette

Note. From *Sports, Games, Recreation, Mountain Biking* by DK Images, 2007, Copyright 2007 by DK Limited. Retrieved November 5, 2007, from <http://www.dkimages.com/discover/Home/Sports-Games-Recreation/Outdoor-Adventure/Mountain-Biking/index.html>

Typically, mountain bikes have two or three chainrings in the front and seven to nine cogs in the back. Each of these sprockets is attached to a numerical value, which corresponds to the numbers on the gear-shifting mechanism attached to the handlebars.

Chainset

The chainset is numbered one through three. The biggest chainring in the chainset—three—is located on the outside of the set while the smallest chainring in the chainset—one—is located on the inside of the set.

The biggest chainring in the chainset is used for flat terrain, high speeds, downhill and road pedalling. The middle chainring in the chainset is for most off-road situations including single track, small hills and bumpy downhills. The smallest chainring in the chainset is used for steep uphill and very difficult technical terrain.

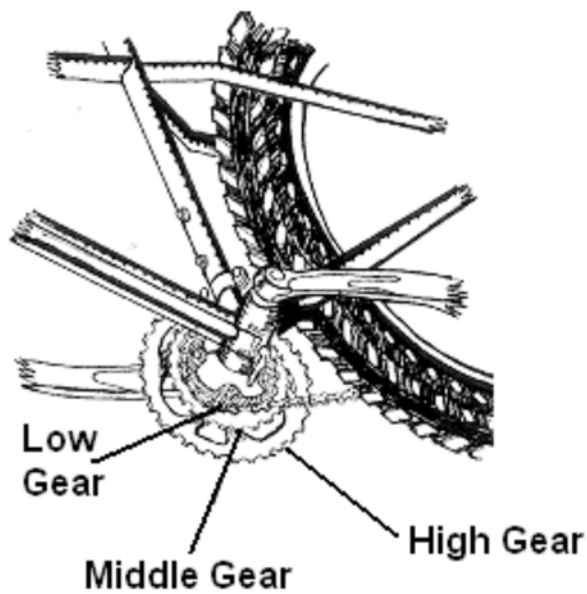

Figure 12 Front Chainset

Note. From *Your First Mountain Bike Moves: Shifting Gears* by Gorp, 2007, Copyright 2007 by Orbitz Away LLC. Retrieved November 7, 2007, from http://www.gorp.away.com/gorp/publishers/menasha/how_ride5.htm

Cassette

The cassette is numbered one through nine from the inside, closest to the frame, to the outside. The inside cogs, the larger sprockets, equal the low and easiest gears which are primarily used to climb hills and when traversing uneven terrain. The outside, smaller sprockets, equal the highest and hardest gears which are used to gain speed on flat terrain.

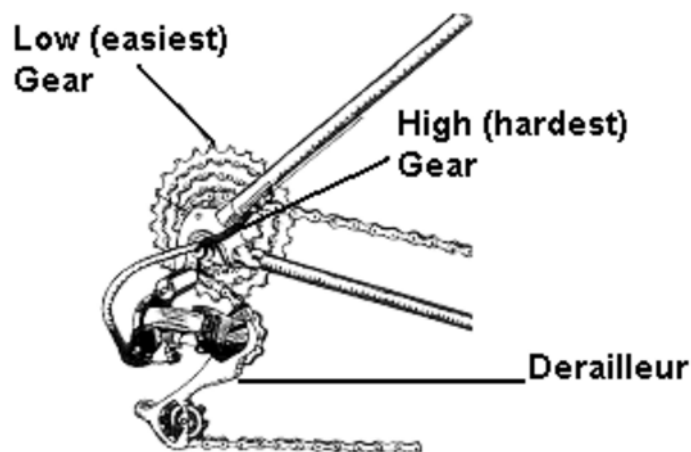

Figure 13 Rear Cassette

Note. From *Your First Mountain Bike Moves: Shifting Gears* by Gorp, 2007, Copyright 2007 by Orbitz Away LLC. Retrieved November 7, 2007, from http://www.gorp.away.com/gorp/publishers/menasha/how_ride5.htm



The mountain bike chain should never be in the big rings on the front and rear at the same time. It places an enormous amount of tension on the chain as it moves the chain from a straight to a diagonal line.

Shifting Gears

As with braking, the left gear shifter controls the chainrings on the front chainset, while the right gear shifter controls the cogs on the rear cassette. When the gear shifter is pushed, the derailleur, front or rear, will move the chain from one sprocket to another.



Figure 14 Right Gear Shifter

Note. From *Suspension Mountain Bikes* by 2 Wheel Bikes. Retrieved November 7, 2007, from <http://www.2wheelbikes.com/suspension-mountainbikes/sm3000-mountain-bike.html>

All mountain bike gears are indexed, which means they are pre-set and will click into place when the gear lever is activated. Most mountain bikes have a visual indicator on both sides, which shows what gear the mountain bike is in.

Pushing the gear shifter moves the chain onto a bigger chainring or cog, because the movement is against the spring tension in the derailleur. The mountain biker will have to push the lever further than the resting point so that the chain can make it onto the bigger chainring or cog. This is done with the mountain biker's thumb, because it is stronger than the index finger.

Changing to the smaller chainrings or cogs is an easier motion because the lever is releasing the spring tension, letting the derailleur fall naturally into position. These gear changes are completed using the mountain biker's index finger to pull the lever forward.

It is possible to change more than one gear at a time. This is done through either a series of several clicks or one movement depending on the type of gear shifting mechanism the mountain bike uses.

There are several important points to remember when gearing:

- Gears cannot be changed if the pedals are not moving.
- Cogs are used for small changes in speed, like when the mountain biker is climbing a long steady hill.
- Chainrings are for bigger changes in speed, such as descending the summit of a hill.
- The ideal gear to begin biking is somewhere in the middle of the cassette, four or five, and the middle chainring.

Ascending Hills

Climbing hills is a challenge when mountain biking and the mountain bike has been specifically designed to meet this challenge. Its broad, knobby tires, the position of the mountain biker over the back wheel and the increased number of gears give the mountain bike the technical ability to ascend hills.



A mountain bike can handle inclines close to 45 degrees on badly broken ground.

Being able to ascend a hill is influenced by two factors—balance and power. Balance is gained through awareness and practice, while power is gained through repetition of the skill and muscular and cardiovascular strength.

The following are factors that affect the mountain biker's technique while attempting to ascend a hill.

Position. The centre of gravity of a mountain bike and the mountain biker is located at the mountain biker's abdomen. When climbing a hill, the centre of gravity must move forward on the mountain bike to enable the mountain biker to keep their balance. The mountain biker should pull their body weight forward on the mountain bike as the climb gets steeper, otherwise the front tire will not have enough weight on it and will lift up, resulting in a fall.



Centre of gravity is the point where all the weight of an object is concentrated.



Figure 15 Proper Ascent Position

Note. From *The Complete Mountain Bike Book* (p. 51), by T. Brink, 2007, Camden, ME: Ragged Mountain Press. Copyright 2007 by New Holland Publishers Ltd.



While it may seem easier to stand up from the saddle when climbing hills, it in fact requires more power and expends more of the mountain biker's energy. Keeping the body low and forward on the saddle is a much more effective climbing position.

Gearing and Shifting. Depending on the steepness of the hill, it is acceptable to have the front chainset on the middle chainring, index two. The rear cassette is more dependent on the grade of the hill. It is advisable, when approaching a hill to begin shifting down into a medium-intensity gear, perhaps four or five. Once the mountain biker has begun the ascent they will have to continue to lower the cogs in relation to their ability to maintain pedal power. Remember that in order to change gears, the pedals have to be moving and the more steep the incline, the harder it will be to pedal.

Descending Hills

Descending is about letting gravity do the work, while the mountain biker concentrates on braking and distributing weight. It becomes a combination of balance and applying the brakes at the correct time. Riders must always think ahead and be aware of rough terrain, corners, obstacles and other mountain bikers that may be on the trail. It is critical to apply the brakes enough to move around or by disturbances but not too much to avoid completely losing the momentum from the hill.

Position. When descending a hill it is critical that the centre of gravity of the mountain biker does not fall more than halfway down the top tube of the mountain bike. If it does, the mountain biker may go over the handlebars. The mountain biker should move their body weight toward the back of the mountain bike, be as low as possible and extend their arms so they are almost straight in front of them. Depending on the steepness of the hill, the mountain biker may want to slide their bottom off and behind the saddle for further stability.



Figure 16 Proper Descent Position

Note. From *Suspension Mountain Bikes* by 2 Wheel Bikes. Retrieved November 7, 2007, from <http://www.2wheelbikes.com/suspension-mountainbikes/sm3000-mountain-bike.html>

Gearing and Shifting. Gearing and shifting are not as critical when descending hills as they are in ascending hills. The key thing to remember is that descending hills provides momentum, and speed must be maintained once the hill has ended. To do this, think ahead and shift into gears that will provide the most momentum. The

front chainset should be in the biggest chainring and the rear cassette should be in the highest gear, eight. It may be necessary to shift to lower gears once the momentum from the hill begins to slow and pedalling gets harder.



Speed must be controlled when descending hills, with the mountain biker applying equal brake pressure, as required, on both the front and rear brakes. The mountain biker's hands must remain on the brake levers for the duration of the descent and should be ready to brake at all times.

DISCUSS MOUNTAIN BIKING ON INTERMEDIATE TRAILS

Mountain bike trails are classified by mountain biking organizations. The mountain biking community has been very persistent in establishing consistent criteria for the rating of all types of mountain bike trails—multi-use, single-use, double track and single track.



The International Mountain Bicycling Association (IMBA) developed a basic method to categorize the technical difficulty of recreation trails. The system was adapted from the International Trail Marking System used at ski areas throughout the world.

The IMBA Trail Difficulty Rating System has been created to:

- help trail users make informed decisions;
- encourage visitors to use trails that match their skill level;
- manage risk and minimize injuries;
- improve the outdoor experience for a wide variety of visitors; and
- aid in the planning of trails and trail systems.

Mountain bike trails, in accordance with the IMBA Trail Difficulty Rating System have been divided into three categories based on trail width, trail surface, trail grade, obstacles and technical features.

The CCM has developed its own rating system that combines similar categories of the IMBA—familiarization trails, intermediate trails and advanced trails.

Intermediate trails. Intermediate trails are defined as having some loose surface with minor obstacles such as roots and rocks with a variety of moderate hills that require skills to ascend and descend. Intermediate trails conform to the IMBA category of "More Difficult".

Part of the attraction of mountain biking on intermediate mountain bike trails is the unpredictability of terrain and the obstacles that may be encountered. The following riding considerations should be considered and implemented by the mountain biker when riding on intermediate trails:

- body position,
- speed, and
- control.

Adopt the Appropriate Body Position

A mountain biker's body position is a key factor to successfully mountain bike on intermediate trails. In most cases, body position is dependent on the successful manipulation of the mountain biker's centre of gravity in relation to the type of terrain being ridden on and the obstacles that are being crossed.



Centre of gravity. The point where all the weight of an object is concentrated. The centre of gravity of a bike and the rider is located at the rider's abdomen.



Have the cadets stand with their feet shoulder width apart, locate their navel (belly button) and lean over like they are riding a mountain bike. Have them move from side to side and front to back in the riding position to see how their balance changes as their centre of gravity shifts locations. They may need a partner for this activity.

Adopting the correct position when mountain biking can mean the difference between getting over an obstacle and falling off the mountain bike. Mountain bikers use a standard 'attack' or 'ready' position when mountain biking and adjust it as required depending on the terrain / obstacle being crossed. The attack or ready position is:

- elbows bent and out,
- head up,
- chin low,
- centre of gravity low, and
- seat hovering over the saddle.

Regulate Speed

To successfully traverse the obstacles and varied terrain found on intermediate trails a mountain biker must be able to understand and effectively regulate their speed. Momentum is an ally—without it, riding over rocks / logs / roots / mud would be virtually impossible. Many new mountain bikers, who have low levels of confidence and skill, will slow down as they approach an obstacle—this is due to fear—however, if they keep their speed constant or even a bit faster, they would be able to tackle the obstacle successfully. Speed is controlled by efficient braking and gearing. These two skills are developed through practice and experience.

Braking. Understanding the finer nuances of how the brakes—front and rear—work when engaged together is an important facet of riding on intermediate mountain bike trails.

Gearing. Gearing is a skill that is driven by each individual mountain biker, depending on skill, physical ability and strength. Knowing personal gear efficiencies is critical when traversing over obstacles and varied terrain.

Maintain Control

To ensure safety when mountain biking on intermediate trails, a mountain biker must always be in complete control. Control is maintained by:

- being aware of centre of gravity and adjusting body position accordingly;
- keeping a loose but firm grip of the handle bars; and
- keeping the head up—looking ahead to where the mountain biker wants to go.



Looking up and ahead is one of the hardest skills for mountain bikers to master. At first it feels unnatural, however, looking ahead and not at the ground or object that is being ridden over will ensure success.

TERRAIN AND OBSTACLES THAT MAY BE ENCOUNTERED ON INTERMEDIATE TRAILS

Mountain bikers must be aware of the different types of terrain and obstacles they may encounter when riding on intermediate trails because this will ensure they are well prepared to execute the appropriate mountain bike skill in order to ride over / cross that section of terrain or obstacle.

Terrain

The *Canadian Oxford Dictionary* defines terrain as ground or a track of land, focusing on its physical characteristics and / or its capacity for use.

The following is a list of the different types of terrain a mountain biker may encounter and be required to travel over when mountain biking on intermediate trails:

- grass,
- mud,
- sand,



As soon as sand becomes more than a couple of centimetres (inches) deep, mountain biking feels like riding in molasses.

- water, and
- gravel.

One of the hardest surfaces to ride a mountain bike across is a grassy meadow without a marked trail. River and stream crossings can be dangerous depending on their depth and should only be crossed at the shallowest point. When crossing, push the mountain bike rather than ride it.

Obstacles

The *Canadian Oxford Dictionary* defines an obstacle as a person or thing that obstructs progress.

The following is a list of the different obstacles a mountain biker may encounter and be required to travel over when mountain biking on intermediate trails:

- rocks,
- roots,
- logs,
- ruts,
- crevices, and
- potholes.

Dry rocks present few difficulties for mountain bikers—they require skill in order to tackle them effectively without losing momentum—but moss and rain make riding a very unpredictable experience. Wet or mossy rocks remove traction and can turn a wheel in the opposite direction from where the mountain biker intended. Roots are slippery when dry and dangerous when wet.

MOUNTAIN BIKE ON DIFFERENT TYPES OF TERRAIN

Part of the attraction of mountain biking on off-road trails is the unpredictability that these types of trails offer. A good mountain bike trail will combine a variety of different types of terrain—grass, mud, sand, water and gravel—that will challenge the mountain biker from start to finish. Many mountain bikers hate to be unseated from their mountain bike and hate to walk their mountain bikes. Knowing the intricacies for mountain biking over different types of terrain will limit the occurrences of such events.

Grass

Grass is a constantly changing surface that a mountain bike will react differently to depending on if it is new, worn, dry or wet. A mountain biker will have to adapt their riding technique to suit the conditions. On short, dry grass a mountain bike's tires can grip well and the mountain biker will have little difficulty controlling their mountain bike. However, tire grip will be affected as grass becomes worn and / or wet.

Mountain biking on worn or wet grass is difficult, as the tires' ability to grip the ground is diminished. The following considerations should be taken into account:

- stay in the saddle when ascending hills;
- select a medium to low gear to prevent wheel spin;
- brake lightly; and
- be aware of ruts as they will be slippery and may contain water and holes that cannot be seen.

Mud

Mud is a type of terrain that mountain bikers look forward to and dread at the same time. Compared to dry trails, mud is harder to mountain bike on / through and requires strong mountain bike skills in order to make the ride more manageable, quicker and enjoyable. Mountain bike tires have significantly less grip / traction when going through mud than when on dry trails. Mud slows down the mountain bikers' speed and momentum and clogs up the gears and brakes.

The following considerations should be kept in mind when mountain biking in mud:

- If possible release some air from the tire; this will provide a larger surface area to grip with.
- Keep all actions as smooth as possible.
- Stay seated in the saddle.
- Move the centre of gravity towards the middle of the mountain bike (over the bottom bracket).
- Shift into a low gear (eg, 1 : 4, 1 : 6, 2 : 3, 2 : 4).



Bottom bracket. The bottom bracket is the axel bearing around which the pedals and cranks turn to move the chain.

Sand

Sand is an extremely difficult surface to mountain bike on. Sand is common in coastal areas, but can also be found on inland trails. In dry weather, sand can be found on eroded and well-used trails. Sand is a very loose substance and as such provides nothing for the tires to dig into and severely limits traction, affecting momentum. Mountain bikers must ensure they do not sink in the sand or lose speed in order to make it through the section.

The following considerations should be kept in mind when mountain biking on sand:

- When approaching a section of the trail with sand, look for and follow an already established path.
- Approach the sand with a significant amount of speed.
- Keep the weight off the front wheel by moving the centre of gravity towards the middle of the mountain bike (over the bottom bracket).
- Shift into a medium gear (eg, 1 : 6, 2 : 4, 2 : 5).
- Pedal as smoothly as possible to stop the wheels from spinning.
- Keep the handlebars as straight as possible, using the shoulders and upper body to guide the mountain bike rather than steering it.

Water

There is always a chance that a mountain biker will have to cross some type of water on the trail. Water can be anything from a large puddle to a small creek or stream to a large river. When mountain biking over large rocks covered in water, it is best to aim directly for the stream of water as this will be the cleanest, least slippery section.

The following considerations should be kept in mind when mountain biking through water:

- Approach the water at a medium to high speed to ensure momentum is maintained throughout the crossing.
- Be aware that under the water could be loose and slippery.
- Keep a loose but firm grip on the handlebars—executing smooth controlled movements.
- Move the centre of gravity toward the middle of the mountain bike (over the bottom bracket).
- If the depth of the water is unclear get off the mountain bike and push / carry the mountain bike.



Figure 17 Mountain Biking Through Water

Note. From *Sports, Games, Recreation, Mountain Biking* by DK Images, 2008, Copyright 2008 by DK Limited. Retrieved November 20, 2008, from <http://www.dkimages.com/discover/Home/Sports-Games-Recreation/Outdoor-Adventure/Mountain-Biking/index.html>



In some cases, tackling difficult terrain is easier on foot than on the mountain bike. A mountain biker needs to be aware that this is a possibility and make the decision based on their own skill level and the type of terrain that they are crossing.

The following process should be used to shoulder carry a mountain bike:

1. Stand beside the mountain bike.
2. Keep the mountain bike steady by putting the left (right) hand on the handlebars.
3. Bend at the knees and crouch to put the right (left) arm through the frame.
4. Stand up, with the top tube resting on the right (left) shoulder.
5. Keep the mountain bike steady by holding either the stem or the handlebars.
6. Use the opposite arm as a counterweight to balance while walking or running.

Gravel

Gravel is generally an unpredictable surface to mountain bike on. It usually forms in patches and it is very hard to see and / or determine its depth. The best way to tackle gravel is to avoid it—available alternatives should be taken.



On well-used trails, gravel usually gets pushed to the outside portion of the trail. This allows the mountain biker to avoid the gravel as long as they stay to the middle of the trails.

If a mountain biker must ride through gravel, it is important that they keep movements and actions smooth and controlled—sudden changes in direction and hard braking can cause the wheels to slip and the mountain biker to crash.

PERFORM ADVANCED MOUNTAIN BIKE SKILLS

Falling Off a Mountain Bike

There is a right and wrong way to fall off a mountain bike. When a person falls their natural instinct is to stick out their arm and try to break the fall. This method does not work and usually causes injury to one or more of the following: thumb, finger, hand, arm, and / or collar bone.

To fall correctly, execute a shoulder roll by:

1. pushing the mountain bike away from the body;
2. tucking the arms and head in towards the chest;
3. hitting the ground with the shoulder first; and
4. rolling over.

Log Hops

The most useful skill a mountain biker can have is getting air—being able to lift the wheels off the ground either one or both at a time. Momentum is one of the main reasons a mountain biker would want to lift their front wheel off the ground. Any time the front wheel of the mountain bike hits an obstacle while on the trail, momentum will be lost which will slow down speed.



Many beginner mountain bikers will attempt to lift the front wheel by simply yanking up with their arms. While this method does work, it is not highly effective as the front wheel will only lift marginally off the ground as there is only a small range of motion before the mountain bikers hands hit their chest.

The process to complete a log hop is as follows:

1. Adopt the attack position.
2. Shift the mountain bike into a medium gear (eg, 2 : 5 or 2 : 6).
3. Pedal toward the obstacle at a medium speed and at a right angle.



It is sometimes difficult for a mountain biker to judge when they should begin to execute a skill such as a log hop. A good rule of thumb is to begin the skill at a distance equal to the obstacles height. For example, if the obstacle is 15 cm (6 inches) high then, the mountain biker should begin to execute the skill approximately 15 cm (6 inches) from the obstacle.

4. Adjust body position, approximately one metre (one yard) away from the obstacle by:
 - a. stopping pedalling;
 - b. moving the pedals so they are horizontal;



Pedals are horizontal when they are in the 3 o'clock and 9 o'clock position.

- c. sitting down on the saddle; and
 - d. shifting the body weight toward the rear of the mountain bike.
5. Lift the front wheel just before reaching the obstacle by:
- a. pedalling one half turn;
 - b. compressing the body toward the ground by pushing down on the front fork and front tire;
 - c. pushing the hips backwards to shift the centre of gravity;
 - d. straightening up and pulling up on the handle bars in one fluid motion, while squeezing the saddle with the inner thighs; and
 - e. moving the weight toward the rear wheel to lift up the front wheel.



Step 5 should happen almost simultaneously. Correct timing is critical when attempting to execute a log hop.

- 6. Place the front wheel on the obstacle.
- 7. Stand up on the pedals and move the body weight over the handlebars to transfer the centre of gravity from the rear of the mountain bike to the front.
- 8. Push forward on the handlebars and allow momentum and pedalling action to roll the mountain bike over the obstacle.
- 9. Move the body weight toward the rear of the mountain bike as soon as the front wheel hits the ground.
- 10. Allow the back wheel to roll off the obstacle.
- 11. Continue mountain biking forward.



Figure 18 Log Hop

Note. From Sports, Games, Recreation, Mountain Biking by DK Images, 2008, Copyright 2008 by DK Limited. Retrieved November 20, 2007, from <http://www.dkimages.com/discover/Home/Sports-Games-Recreation/Outdoor-Adventure/Mountain-Biking/index.html>

Cornering

Cornering is a skill that all mountain bikers will be required to execute on a trail. Mountain bikers will turn corners when riding over grass, on loose gravel, in ruts, on steep downhills or during sharp ascents. Wherever the corner is, it is important to steer the bike around the corner safely and without losing their momentum.

There are three essential elements associated with cornering:

- plotting a line;
- controlling the speed; and
- looking ahead.

 A corner can be divided into three main parts:

- entry,
- apex, and
- exit.

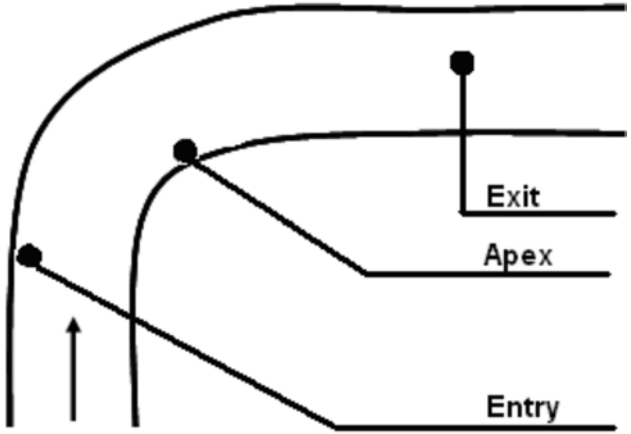



Figure 19 Parts of a Corner

Note. Created by Director Cadets 3, 2008, Ottawa, ON: Department of National Defence.

 Types of corners:

Bermed corner. A bermed corner is also known as a banked corner. The outer perimeter of the corner may be raised too steeply.

Off-camber corner. An off-camber corner is the opposite of a bermed corner. The top of the slope is on the inside and slopes down to the outside of the curve.

Flat turn. A flat turn is the most common type of corner. There are no raised embankments on either side of the corner.

Decreasing radius corner. A decreasing radius corner gets narrower and tighter as it turns. Usually this type of corner is also off-camber.

Increasing radius corner. An increasing radius corner gets wider as it turns.

Plotting a Line

The standard approach to plotting a line is:

1. Approach the corner on the outside.
2. Shift to the inside at the apex of the corner.
3. Move to the outside to exit the corner.

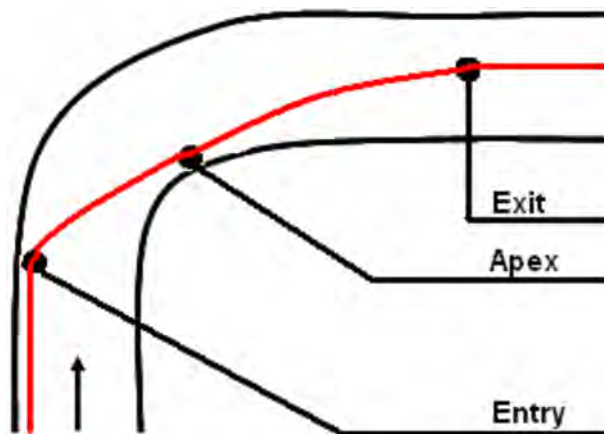

Figure 20 Plotting a Line

Note. Created by Director Cadets 3, 2008, Ottawa, ON: Department of National Defence.

Controlling Speed

When cornering, all the braking should be completed before starting to turn. This is done because it allows the mountain biker to concentrate on exiting the corner. Braking in a straight line is far safer than braking on a corner—a locked rear brake in a corner will slide unpredictably possibly causing a crash.



It is recommended to use the front brakes as much as possible when cornering. It offers more power and control as the mountain biker's weight shifts forward during the turn.

Looking Ahead

It is in people's nature to want to look at the obstacle that they are attempting to steer around and try to avoid it. However, when cornering, the mountain biker should look ahead to where the mountain bike is going and ignore the obstacle. This will allow the mountain biker to look further into the corner and allow their mountain bike to follow the line that has already been established.

Use the following process when cornering:

1. Prepare for the corner by:
 - a. plotting the line;
 - b. engaging the front brakes to slow the mountain bike down; and
 - c. shifting into the appropriate gear for the exit, in order to ensure speed is maintained.
2. Execute the corner by:
 - a. keeping the fingers over the brake levers, applying them as necessary;
 - b. balancing the body between the handlebars and the saddle;
 - c. moving the inside pedal to the 12 o'clock position;
 - d. pushing the weight of the body onto the outside leg;
 - e. bending the inside elbow to pull the body weight forward and inward;

- f. bending the inside knee; and
 - g. pressing down on the straight outside leg.
3. Pedal once the corner has been turned.



Figure 21 Body Position When Cornering

Note. From *Sports, Games, Recreation, Mountain Biking* by DK Images, 2008, Copyright 2008 by DK Limited. Retrieved November 20, 2008, from <http://www.dkimages.com/discover/Home/Sports-Games-Recreation/Outdoor-Adventure/Mountain-Biking/index.html>

ACTIVITY

Time: 270 min

OBJECTIVE

The objective of this activity is to have the cadets, in teams of no more than six, mountain bike on familiarization / intermediate trails, for 40–50 km, during an expedition.

RESOURCES

- Fully equipped mountain bike (one per cadet),
- Personal mountain bike equipment (one per cadet), and
- Group mountain bike equipment (one per team).

ACTIVITY LAYOUT

Designate a familiarization / intermediate mountain bike trail(s), IAW A-CR-CCP-951/PT-002, *Royal Canadian Army Cadets Adventure Training Safety Standards*.

ACTIVITY INSTRUCTIONS

1. Conduct a briefing to include an explanation of:
 - a. the objectives and importance of the activity,
 - b. the resources that may be required to perform the activity, and
 - c. any safety guidelines that must be followed while performing the activity.
2. Have the cadets retrieve their mountain bikes and helmets.
3. Have the cadets conduct a pre-ride bike check.
4. Explain and demonstrate the following advanced mountain bike skills, to include:
 - a. log hops, and
 - b. cornering.
5. Have the cadets, in teams of no more than six, ride a mountain bike on familiarization / intermediate trails, following the designated route for a distance of 40–50 km during an expedition, to practice:
 - a. following road / trail safety regulations;
 - b. braking;
 - c. shifting gears;
 - d. ascending hills;
 - e. descending hills;
 - f. log hops; and
 - g. cornering.
6. Upon arrival at the end point, have the cadets complete a post-ride check and then store / return all equipment.
7. Conduct a debriefing by asking the cadets:
 - a. how they felt about the activity;
 - b. how they felt their team worked together;
 - c. what portion of the activity challenged them the most;
 - d. how their teammates assisted them when they were challenged;
 - e. if there are any specific examples of when their team bonded;
 - f. how the team made decisions;
 - g. whether or not all team members ideas / suggestions were considered; and
 - h. what they would do as a leader of this type of activity to ensure their subordinates enjoyed the experience.

SAFETY

- Each team will be led by the assigned team leader.
- Team Instructor(s) [TIs] must be in sight / sound of the team at all times.
- In areas of complex / technical terrain TI(s) will demonstrate requisite skills as required.
- Teams will travel separately on the same trail.
- There will be a minimum of 500 m between teams at all times.
- Each team will have a cadet positioned at the rear wearing a reflective vest.
- Cadets must travel in single file at all times.
- Cadets must ensure there are at least two mountain bike lengths between them and the person to their front and rear.
- Cadets must carry at least 1 L of water.
- Water re-supply points will be located along the route.
- Meals will be provided at a pre-determined location(s) and detailed in the route instructions.

CONFIRMATION OF TEACHING POINT 1

The cadets' participation in riding a mountain bike will serve as the confirmation of this TP.

END OF LESSON CONFIRMATION

The cadets' participation in the activity will serve as the confirmation of this lesson.

CONCLUSION

HOMEWORK / READING / PRACTICE

Nil.

METHOD OF EVALUATION

This lesson is assessed IAW A-CR-CCP-704/PG-001, *Gold Star Qualification Standard and Plan*, Chapter 3, Annex B, 426 PC.

CLOSING STATEMENT

Mountain biking is a fun and challenging mode of transport that can be used during expeditions. It is critical to understand the importance of maintaining a mountain bike and riding it safely. Being able to perform mountain bike skills will allow for an enjoyable and safe experience when mountain biking.

INSTRUCTOR NOTES / REMARKS

Expedition centres are required to select two dynamic modes of travel from EO M426.02a (Paddle a Canoe), EO M426.02b (Ride a Mountain Bike), EO M426.02c (Hike Along a Route), EO M426.02d (Snowshoe Along a Route) and EO M426.02e (Ski Along a Route) to incorporate into the expedition training.

This EO has been allocated nine periods in the overall course period allocation. Each expedition centre may adjust this allocation to reflect the choice of activities, facilities and available resources at the expedition centre.

Upon arrival at the expedition centre, cadets will be divided into teams. Cadets will be given an opportunity to navigate and lead peers. These teams will remain the same for the duration of the weekend.

IAW A-CR-CCP-951/PT-002, *Royal Canadian Army Cadets Adventure Training Safety Standards*:

1. a fully equipped mountain bike is described as having the following:
 - a. bell or horn,
 - b. lights, and
 - c. reflectors;
2. the following personal mountain bike equipment is required when riding a mountain bike:
 - a. helmet,
 - b. water carrier,
 - c. day pack, and
 - d. whistle; and
3. the following group mountain bike equipment is required when riding a mountain bike:
 - a. reflective vest (worn by person in rear of group),
 - b. topographical / trail map of area as required,
 - c. compass,
 - d. first aid kit,
 - e. communication device (eg, cellular phone or hand-held radio),
 - f. GPS receiver, and
 - g. mountain bike repair kit, to include:
 - (1) spare tube,
 - (2) tube patch kit,
 - (3) tire levers,
 - (4) bike multi-tool, to include:
 - (a) 2-, 2.5-, 3-, 4-, 5-, 6- and 8-mm hex keys,
 - (b) chain tool,
 - (c) flat screwdriver,
 - (d) Phillips screwdriver,

- (e) T-25 Torx spoke key,
- (f) spoke wrenches, and
- (g) 8- and 10-mm open wrenches; and
- h. mini pump with gauge.

Ensure each cadet has a day pack and an ample supply of water when mountain biking.

A mountain bike cleaning kit is comprised of the following items:

1. bucket,
2. hand brush,
3. cleaning cloth,
4. sponge,
5. small brush,
6. stiff brush,
7. dish soap, and
8. lubricant.

REFERENCES

A2-001 A-CR-CCP-951/PT-002 Director Cadets 3. (2006). *Royal Canadian Army Cadets adventure training safety standards*. Ottawa, ON: Department of National Defence.

C2-082 ISBN 1-57954-883-0 Downs, T. (2005). *Bicycle maintenance & repair for road & mountain bikes*. USA: Rodale Inc.

C2-083 ISBN 0-07-149390-5 Brink, T. (2007). *The complete mountain biking manual*. Camden, ME: Ragged Mountain Press.

C2-084 ISBN 1-55297-734-X Allwood, M. (2004). *Mountain bike maintenance: The illustrated manual*. Richmond Hill, ON: Firefly Books Ltd.

C2-087 Badyk, M., Buck, K., Sahl, N., Schultz, R., & Vrooman, D. (1998). *Ontario learn to mountain bike clinic workbook* (2nd ed.). North York, ON: Ontario Cycling Association and Ontario Recreational Mountain Bicycling Alliance.

C2-088 ISBN 1-55297-653-X Crowther, N. (2002). *The ultimate mountain bike book: The definitive illustrated guide to bikes, components, techniques, thrills and trails*. Toronto, ON: Firefly Books Ltd.

C2-089 Ministry of Transport Ontario. (2007). *Young cyclists guide*. Retrieved October 5, 2007, from <http://www.mto.gov.on.ca/english/safety/cycling/youngcyclist.htm>

C2-090 International Mountain Bicycling Association. (2007). *Trail difficulty*. Retrieved October 10, 2007, from http://www.imba.com/resources/trail_building/itn_17_4_trail_difficulty.html

C2-092 Ministry of Transport Ontario. (2007). *Cycling skills: Cycling safety for teen and adult cyclists*. Retrieved October 5, 2007, from <http://www.mto.gov.on.ca/english/pubs/cycling/cyclingskills.htm>



ROYAL CANADIAN ARMY CADETS
GOLD STAR
INSTRUCTIONAL GUIDE



SECTION 4

EO M426.02c – HIKE ALONG A ROUTE

Total Time:

270 min

PREPARATION

PRE-LESSON INSTRUCTIONS

Resources needed for the delivery of this lesson are listed in the lesson specification located in A-CR-CCP-704/PG-001, *Gold Star Qualification Standard and Plan*, Chapter 4. Specific uses for said resources are identified throughout the instructional guide within the TP for which they are required.

Review the lesson content and become familiar with the material prior to delivering the lesson.

Every cadet must have a water carrier prior to the start of this lesson.

PRE-LESSON ASSIGNMENT

Nil.

APPROACH

The experiential approach was chosen for this activity as it allows the cadet to acquire new knowledge and skills through a direct experience. The cadet experiences hiking on Class 3 terrain during an expedition and defines that experience on a personal level. The cadet will be given the opportunity to reflect on and examine what they saw, felt and thought while hiking and consider how it relates to what they already learned and experienced as well as how it will relate to future experiences.

INTRODUCTION

REVIEW

Nil.

OBJECTIVES

By the end of this lesson the cadet shall have hiked 10–15 km along a route with some Class 3 terrain , during an expedition.

IMPORTANCE

It is important for cadets to be able to hike along a route that contains Class 3 terrain so they will be prepared for the technical challenges if / when given the opportunity to participate in more advanced level expeditions. Hiking is not just about walking along a trail or predetermined route; it requires the individual to be aware of their surroundings, their limitations and the limitations of the group they are travelling with. Knowing what to do when an obstacle is on the route is critical for everyone's safety. As well, having a basic knowledge and understanding of techniques such as the "rest step" will make the hike more enjoyable for all members.

Teaching Point 1**Participate in hiking familiarization.**

Time: 270 min

Method: Experiential Learning

BACKGROUND KNOWLEDGE

The TP for this lesson will be presented during hiking familiarization training. Some material may be presented prior to departure, with the remainder being incorporated into teachable moments and breaks throughout the route. Cadets will have been introduced to many of the theoretical concepts; this activity will provide them the opportunity to put into practice what they have already learned.

THE DIFFERENCE BETWEEN HIKING, TREKKING AND BACKPACKING

Hiking is an activity of vigorous walking in the outdoors / wilderness on an unpaved trail, either on a path or navigating along an unmarked route. Usually day hikes consist of travelling cross-country over different terrains, sometimes with inclines and declines. It provides individuals the opportunity to travel to destinations that could not, in many cases, be seen any other way.

The aim of hiking is to learn skills beneficial to physical health. It offers an alternative learning environment and allows participants to explore the outdoor surroundings. For individuals who have never participated in hiking activities, it can be quite challenging. However, it can also offer a challenge to experienced hikers by varying the location / terrain of the hikes.

Trekking is a journey over long distances over several challenging days. Usually trekking involves terrain that requires crossing obstacles.

Hiking becomes backpacking when equipment is carried for an overnight stay.

PERSONAL CLOTHING AND EQUIPMENT FOR HIKING**Clothing**

Clothing for the outdoors is slightly different than everyday clothing, yet everyone has clothing at home they can wear outside. When choosing clothing for outdoors, consider clothing that:

- is in good repair,
- breathes: perspiration must be able to escape the body and evaporate (depending on exertion, the body will warm up and become damp, even sweaty),
- is appropriate for the weather conditions and the activity,
- is made of materials that dry easily,
- offers wind and rain protection resistance,
- insulated and padded,
- flexible without drag,
- can be layered as necessary, and
- is comfortable.

Footwear

The most important factor to consider when selecting hiking footwear is fit. The footwear should be sufficiently sturdy to hold together throughout a trip. It should provide protection for the feet, and a firm foundation for walking and scrambling. Today, boots are derived from athletic shoe technology. They are light, comfortable and functional. Common characteristics to look for when selecting a hiking boot are:

Sturdy. The boot should support feet and ankles from twisting on uneven surfaces. Higher boots with stiff ankle support provide lateral rigidity. The boot should also support the foot from overextending when placing too much weight on the toe or heel.

Lightweight. The lighter the boots the easier walking will be. Every extra pound of footwear weight can be compared to five pounds of added backpack weight.

Comfortable fit. When worn, boots shall fit snugly with the heel snug against the wall of the shoe and a small amount of space for the toes to move.

Correct size. Proper fitting boots ensure comfort during hiking. A boot fits correctly when:

- it is wide enough so the boot matches the width of the foot with little extra room,
- the tongue rests comfortably along the top of the toe, and
- the toes have room to wiggle.

Socks

The boot is only part of the footwear system; socks are the first line of defence for the feet. A two-sock system is common in many activities. Unless hiking regularly in hot, damp conditions, consider wearing one pair of heavy socks and one pair of light, inner socks. Always ensure socks are properly sized for the foot.

Inner socks. This is a thin layer that helps wick, or pull moisture away, from the foot. They are usually made of a polypropylene material.

Outer socks. This layer is most often made of wool or a wool blend, which can absorb moisture. This layer cushions the foot and provides insulation.

Pack

There are many devices made to assist in carrying loads on a hike. For day trips, use a small pack which can comfortably hold all required items. In the winter, there may be a requirement for extra capacity.

Fanny pack. The pack for short hikes or treks up to a few hours is a fanny pack. This pack is a small, unobtrusive pack that sits atop the buttocks, with a thin belt that clips around the waist. These are also known as waist, or lumbar, packs. The simplest of these packs consists of a pouch sewn to a piece of flat webbing. More elaborate fanny packs can hold upwards of 10 L, and have padded belts and suspensions. The fanny pack is lightweight, and holds the load close to the spine and a person's centre of balance. Items carried in a fanny pack should be limited to 4.5 kg (10 lbs).



Figure 1 Fanny Pack

Note. From ABC-of-Hiking, 2007, *Shop Backpacks*, Copyright 2007 by Max Lifestyle.net "Go Hiking Like Max". Retrieved April 19, 2007, from <http://www.abc-of-hiking/shopitems/backpacks/prowler5-backpacks.asp>

Day pack. Day packs are produced in numerous model types; however, all have shoulder straps and a waist belt. Most day packs have pockets for organizing equipment and basic exterior features (eg, axe loops and daisy chains).

Important qualities of a good day pack include:

- back padding to protect shoulder blades,
- firmly padded shoulder straps,
- adjustment straps for placing weight between shoulders and hips,
- an internal frame (more durable and comfortable to wear),
- padded hip belt; four inches wide around hips and two inches at the buckle, and
- 35–40 L in volume (roughly 9–13 kg [20–30 lbs]).



Figure 2 Day Pack

Note. From ABC-of-Hiking, 2007, *Shop Backpacks*, Copyright 2007 by Max Lifestyle.net "Go Hiking like Max". Retrieved April 17, 2007, from <http://www.abc-of-hiking/shopitems/backpacks/team-backpacks.asp>

Ten Essential Items

Water carrier. One indispensable item in any wilderness traveller's kit is a water carrier. Carrying water during a hike requires a lightweight water bottle with a tight lid that is easily refillable. Versatile equipment benefits the user. When choosing a bottle it is advisable to choose one that can withstand the temperatures of frozen or hot liquids.



Wide mouth bottles are a practical choice as many water filters are built to twist directly onto the opening of the bottle. This simplifies the water filtering process.



Hydration bags are an excellent water carrying device which allows the user to easily carry between 1 L and 4 L of water at a time. They are built into a pack and consist of a lightweight plastic bladder and a drinking tube that passes over the shoulder of the user and allows for easy hydration while hiking.



Figure 3 Wide Mouth Water Bottle

Note. From "Mountain Equipment Coop", Copyright 2007 by Mountain Equipment Coop. Retrieved March 28, 2007, from http://www.mec.ca/Products/product_detail.jsp?PRODUCT%3C%3Eprd_id=845524442500177&FOLDER%3C%3Efolder_id=2534374302696609&bmUID=1177425692300



Figure 4 Hydration Bag

Note. From "Bionic Sports", Copyright 2007 by Bionic Sports. Retrieved November 16, 2007, from <http://www.bionicsports.com/acatalog/Hydration.html>

Pocket knife. A knife or multi-purpose tool is essential for repairing equipment and cutting rope, cord or bandages. The key is to find a knife or tool that is small but has all the attachments—blade, scissors, screwdriver—that may be required while out on a hike.

Extra food. It is always advisable to bring extra food on a hike. Snacks such as granola bars, GORP (good old raisins and peanuts), chocolate bars, and dried fruit will provide the hiker with an energy boost. In an emergency situation they may increase chances of survival.

Extra clothing. Extra clothing includes an additional layer of warm clothing and a rain coat. A light down vest, sweater, or fleece jacket will provide insulation should the weather be cooler than expected, and during breaks

when sweat evaporates and the body cools. Just because the sun is shining at the start of a hike does not mean it will be shining at the end. Rain coats may also be used in building a shelter in an emergency situation.

Sunscreen. Sunscreen blocks or prevents the skin's exposure to the sun or ultraviolet light. The skin will burn when the amount of exposure to the sun, or ultraviolet light source, exceeds the ability of the body's protective pigment to protect the skin. According to the *Canadian Dermatology Association* a minimum of SPF 15 with UV-A and UV-B protection should be worn.

Sunglasses. Hikers should always wear sunglasses to protect their eyes against damage from the sun's light (eg, ultraviolet, bright or intense light, and blue light). This is especially important in the winter, as snow blindness is a prevalent injury.

Hat. A wide brimmed hat will protect the back of the neck, ears, and face from burning. A toque in the winter will keep the hiker's ears warm and stop the escape of heat from the head.

Insect repellent. Annoying mosquitoes and black flies can have a negative impact on a hike. Wear loose fitting clothing with closed cuffs and apply insect repellent to ward off unwanted insects. The repellent should be applied to the exposed areas of the body. Many insect repellents rely on chemicals such as DEET to repel insects and have long durations per application.

Headlamp. A headlamp is simply a flashlight that has been attached to an adjustable strap that fits around the user's head. It is beneficial on a hike as it frees up the user's hands to complete tasks when light is low or it is dark.



Figure 5 Headlamp

Note. From "Mountain Equipment Coop", Copyright 2007 by Mountain Equipment Coop. Retrieved November 16, 2007, from http://www.mec.ca/Products/product_detail.jsp?PRODUCT%3C%3Eprd_id=845524442621000&FOLDER%3C%3Efolder_id=2534374302697057&bmUID=1195238790425

Survival kit. Having a survival kit is a must during any wilderness hiking trip. It should include water purification tablets, a light source, waterproof matches, a signalling device and first aid materials.

Notebook and pencil. Having a notebook and pencil will allow hikers to keep a log throughout the hike. Collecting information such as route details, trail condition, trail difficulty, and general observations will provide the individual with beneficial material when planning other hikes. It will also provide a record of the experience.

TERRAIN

Terrain is the physical characteristics of the ground, whether it is a flat, straight trail or an ice-peaked mountain. There are different types of terrain that one can expect to encounter on a route.



IAW with A-CR-CCP-951/PT-002, *Royal Canadian Army Cadets Adventure Training Safety Standards*, the CCM uses the Yosemite Decimal System (YDS) to rate trail difficulty levels. YDS has a scale from 1–5 and it rates the hardest / most technical section on a terrain / route. It also provides ratings for travel over flat terrain.

Class 1. Hiking, usually on a trail.

Class 2. Simple scrambling, crossing obstacles with the occasional use of hands, requires route-finding skills, may be backcountry dense bush.

Class 3. Angle is steep enough that hands are required for balance; scrambling on rocks using hands and feet, a rope might be carried.

Class 4. Simple climbing, often with exposure requiring a rope belay. A fall could be serious or fatal. Natural protection can usually be easily found.

Class 5. Technical rock climbing begins. Climbing involves the use of ropes, belays, and the placement of natural or artificial protection for the leader in case of a fall. An open-ended decimal extension to Class 5 exists for rating climbs within this category.

Types of Terrain

Easy terrain. Terrain is flat and footing is secure. Forest roads, trails following streams and rolling hills are generally easy walking.

Moderate terrain. Terrain with a trail that is mostly solid under foot with either one fairly steep hill or a series of small hills or forest floors with light underbrush.

Difficult terrain. Any terrain in which a person ascends or descends over 150 m in 1 km. It can also consist of patches of dense forests, thick vegetation and rocky trails / root covered trails.

Rates of travel will differ, depending on the group, equipment, terrain, elevation above ground, etc. Generally:

- On easy terrain with a pack, a group can be expected to travel 3–5 km / h.
- On difficult terrain with a pack, a group can be expected to travel 1.5–3 km / h.
- In difficult terrain, the rate of travel can drop to a third or even a quarter of what it would be on easy terrain.
- When above 3000 m, the rate of travel will greatly decrease. On average, a person will travel 1 km / h less for every 1000 m gained in elevation.
- When descending on easy terrain, the rate can be up to twice the speed of the ascent.

USING TREKKING POLES WHILE HIKING

Types of Poles and Sticks

There are three types of trekking poles—ski poles, wooden walking sticks and telescoping trekking poles. Depending on the activity, the choice of pole will be different.

Trekking poles provide better balance and reduce the amount of stress on the knees, shoulders and back. They absorb some of the impact the body would otherwise absorb. The poles, rather than the body, absorb shock, reduce arm and leg fatigue and improve endurance.

Ski poles and walking sticks may be used for long walks and easy treks on fairly level surfaces. The walking stick may be an acceptable choice for moderate treks. Telescoping trekking poles are the most versatile choice. They work well for hiking and trekking on rough terrain.



Figure 6 Ski Pole

Note. From Black Diamond, 2005, *Gear*, Copyright 2006 by Black Diamond Equipment Ltd. Retrieved April 12, 2007, from http://www.bdel.com/gear/fixed_length_ski.php



Figure 7 Telescoping Trekking Pole

Note. From Wintergoodies.com, 2007, *Hiking, Trekking & Walking Pole Adjustable*, Copyright 2007 by Wintergoodies.com. Retrieved April 12, 2007, from http://www.winterbrookgoodies.com/pd_swissgear_hiking_trekking_walking_pole.cfm



Figure 8 Wooden Walking Stick

Note. From The Walking Stick, 2005, *Hiking Poles & Walking Sticks & Staffs*, Copyright 2005 by The Walking Stick. Retrieved April 12, 2007, from <http://www.backpacking.net/walkstik.html>

Criteria for Choosing Trekking Poles

To find the right trekking poles or walking stick, one needs to consider the type of activities for which they will be used, the type of terrain and the weight one will carry.



Aluminum telescoping poles are the best option. They are affordable and will last longer.

Telescopic adjustment. Poles with telescopic adjustment may be adjusted to be longer or shorter depending on the type of terrain. Multiple people can use the same set of poles by adjusting the length. The poles are easy to store when not in use.

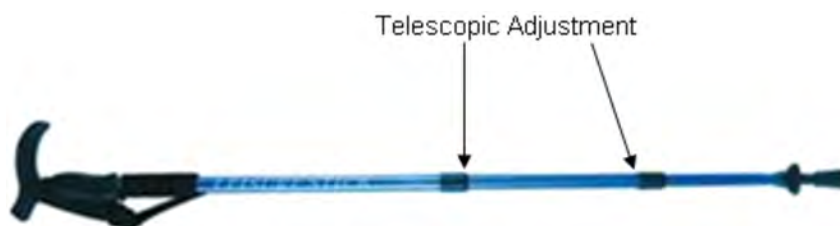

Figure 9 Telescoping Pole

Note. From Alibaba.com, 2007, *Trekking Poles*, Copyright 2007 by Alibaba.com Corporation and Licensors. Retrieved April 17, 2007, from http://aoqida.en.alibaba.com/product/50252655/51316862/Trekking_Poles/Trekking_Pole.html

Grips. Grips that have been shaped to fit the hand are more comfortable to grasp and easier to use over a long period of time. Grips that are hard can get wet with sweat and be uncomfortable to hold. One should try multiple models to find the one that fits the hand the best. An adjustable strap should be attached to the grip to prevent dropping the pole.



Figure 10 Grip With Strap

Note. From Moontrail, Backcountry Equipment Ltd, 2006, *MSR Denali II, Telescoping Trekking Poles*, Copyright 2006 by Backcountry Equipment, Ltd. Retrieved April 17, 2007, from <http://moontrail.com/msr-denali2.php>

Anti-shock system (shock absorption). The anti-shock system is built into the pole. Some systems are very complex and offer a range of settings depending on the user's preferences and the conditions of the trek. The anti-shock system helps absorb the impact of the pole striking the ground as one walks, easing the strain on the shoulders and arms. A lock system is a must as it allows the user to ensure the settings are locked and will not change during the hike.

Baskets. Baskets are the round rings at the bottom of trekking poles. The basket stops the poles from sinking into the surface (snow, mud or waterlogged ground). There are a variety of baskets. Baskets that are cut out like snowflakes are best used in the snow. Large, solid baskets are best used on soft muddy ground as they prevent sinking. If one is planning to buy trekking poles with baskets, ensure the baskets can easily be changed.



Figure 11 Snowflake Baskets

Note. From Backcountry Edge, 2004, *LEKI Snowflake Baskets*, Copyright 2004 by Backcountry Edge, Inc. Retrieved April 17, 2007, from http://www.backcountryedge.com/products/leki/snowflake_baskets.aspx



Figure 12 Solid Baskets

Note. From Backcountrygear.com, 2007, *Black Diamond Trekking Pole Spare Baskets*. Retrieved April 17, 2007, from <http://www.backcountrygear.com/catalog/accessdetail.cfm/BD320>

Tips. There are three types of tips—single point, chiselled and rubber tipped. Each of these tips will work well in a certain environment. The best overall tip is the chiselled. It looks like notches have been cut out of the very tip of the pole, leaving several points sticking out. This type of tip offers traction in almost any condition and is durable.



Figure 13 Replaceable Tips

Note. From GoSki-Real Resort Info, 2005, *Poles and Trekking Poles*, Copyright 2005 by RSN. Retrieved April 17, 2007, from http://www.goski.com/gear/product/LifeLink_Replaceable_Flex_Tip_Pair.html

Methods of Use

Using trekking poles may help prevent aches and pains. Poles are useful to help stabilize heavy loads and to negotiate trails. Besides providing better balance, trekking poles reduce the amount of stress on the back, legs and especially the knees. The poles absorb some of the impact the body would have to endure.



As the explanation is given, demonstrate the different techniques for holding trekking poles.

Trekking uphill. When walking on even terrain, arms should be parallel to the ground when holding the grip. When trekking uphill, shorten the trekking poles for comfort and stability. This allows one to gain more power.



Figure 14 Trekking Uphill

Note. From TrekkingPoles.com, 2006, *How to Use Trekking Poles*, Copyright 2006 by NicheRetail, LLC Company. Retrieved April 26, 2007, from http://www.trekkingpoles.com/custserv/custserv.jsp?pageName=How_To_Use

Trekking downhill. Trekking poles will help reduce the shock of each footfall on the joints when going downhill. For comfort and stability it is recommended that the poles be lengthened.



Figure 15 Trekking Downhill

Note. From TrekkingPoles.com, 2006, *How to Use Trekking Poles*, Copyright 2006 by NicheRetail, LLC Company. Retrieved April 26, 2007, from http://www.trekkingpoles.com/custserv/custserv.jsp?pageName=How_To_Use

The following may help while descending on rocky terrain:

- Walk slowly and test each rock before placing body weight on it.
- Lean forward to place body weight on the trekking poles.
- Grip the trekking pole securely.
- Keep the arms bent at 90 degrees.
- When possible, move one pole forward and step through with the opposite leg.



Trekking poles can also be used to:

- probe the depth of puddles or the strength of snow bridges;
- ward off aggressive animals; and
- provide support for a camera.



Some people like to have one hand free and only use one pole. For a greater level of support, two is better.

A solid wooden walking stick can be picked up in nature at any time during an expedition.

PERSONAL HIKING RHYTHM

An average day of hiking will consist of periods of hiking and periods of rest. The combination of a good hiking rhythm, a good hiking speed, and fixed rest intervals separate beginners from experienced hikers. Enthusiasm often tends to cause one to start too fast, get tired quickly, take an early rest, and start off too fast again.

Stride Rhythm and Speed

A steady hiking rhythm is generally more enjoyable as one over exerts themselves less and generally keep the physical strain at comfortable levels. Having a steady rhythm will enable a hiker to stick to a fixed schedule and lessen the strain put on the body. This allows a hiker to travel less fatigued.

Developing a hiking rhythm. A hiking rhythm is very personal and is developed over the course of many hikes. To develop a rhythm there are some guidelines to follow:

- Choose a specific stride rhythm and speed and keep to it. A good rhythm is one that allows a hiker to hike at the same intensity level for at least one hour without having to take a break.
- Adjust rhythm to terrain, weather and weight. The point where a person can no longer carry on a conversation indicates the hiker has gone beyond a comfortable tempo.
- Make the rhythm a full body movement where breathing and swinging of the arms happen in harmony.
- Uneven surfaces like uphill and downhill slopes of varying incline can make it difficult to maintain a steady hiking rhythm.

Controlling Fatigue

The purpose of resting is to slow down the heart rate and breathing, thereby allowing the heart and lungs to rest. Resting gives the body time to get rid of the lactic acids built up in muscles, and to recover from hot spots or sores.

Resting guidelines:

- Rest in regular intervals; try 10 minutes for every hour hiked (make them part of the rhythm).
- Stick to 10-minute rest breaks. Use only lunch and dinner (supper) breaks as extended rest periods.
- 10 minutes is the most effective rest duration for body recovery.
- Ensure to take off backpacks, rest in the shade, and sit down during rests.
- During the extended rest breaks, allow feet to rest and dry by removing shoes, and airing out footwear.

Adjusting Rhythm

Generally, hiking rhythm on a flat surface can be maintained easily; however, when weather and additional weight are included, hiking becomes more difficult. How fast one travels depends on the fitness level of the entire group, the terrain, the altitude and pack weight. One of the best ways to measure and regulate pace is to pay close attention to the tempo of breathing.

If breathing determines pace then, for example, on level ground one takes three steps per inhalation, and three steps per exhalation. Climbing a hill, while maintaining the same breathing rate, the steps per inhalation fall to two. A good rule of thumb to follow is to walk at a pace where one can still carry on a conversation.

When travelling in different conditions one's pace will change, according to:

- **Weather.** Poor weather will reduce pace and force the hiker to reduce step size for safety.
- **Weight.** Weight will affect pace size as the more weight one carries, the more energy must be expelled.
- **Terrain.** Travelling uphill will reduce pace size and distance travelled.

Full Body Synchronization

Hiking rhythm is a full body affair. Just like marching, hiking requires coordinated movements where every action has a reaction. The swinging of arms provides momentum, breathing controls pace, etc. To properly control rhythm, one must first learn what body parts work in unison. To employ full body synchronization during movement, the arms should be in motion at a natural swing, opposite the forward foot.

Resting Intervals

An average day of hiking consists of periods of hiking and resting. Resting intervals should occur once every hour, for a duration of 10 minutes, in an area that is conveniently shaded and possibly near a water source. During the first five to seven minutes of resting, the body flushes out about 30 percent of the lactic acid buildup in the muscles, but only five percent in the next 15 minutes (be cautious rest does not extend beyond 10 minutes).

In addition to lactic acid buildup in the muscles, the body works in unison and other areas may become fatigued. By resting:

- the heart rate slows and beats at a reduced rate,
- the lungs supply less oxygen to the body,
- the body and mind rest, and
- feet and footwear can be aired out, reducing the chance of blisters.

The Rest Step

When trekking, sometimes a hill is so steep that it simply cannot be climbed without taking breaks. In these cases, the rest step can be used. The rest step is also good when hiking in snow and fog.

To employ the rest step:

1. Begin from an upright position. Step forward with the right leg, keeping the weight on the left (back) leg, with the knee locked. Pause before taking the next step, with the weight still on the back leg.
2. Transfer the weight to the right leg. Push up with the right leg and take a step forward with the left leg. Lock the right knee, so that the right leg is bearing all the body weight. Pause before taking the next step, with the weight still on the back leg.

3. Transfer the weight to the left leg. Push up with the left leg and take a step forward with the right leg. Pause before taking the next step, with the weight still on the back leg. Continue moving, walking at a slow and steady pace.



Step 1



Step 2



Step 3

Figure 16 Rest Step

*Note. From *Backpacking and Hiking* (p. 143), by K. Berger, 2005, New York, NY: DK Publishing Inc. Copyright 2005 by DK Publishing, Inc.*

CLASS 3 TERRAIN HIKING TECHNIQUES

Scrambling

Scrambling is a term used to describe making one's way over rough, uneven terrain and rocks by climbing or crawling. Scrambling usually requires the use of both hands and feet.

The following should be considered when using the scrambling technique:

- Test handholds and footholds before committing body weight.
- Keep the lower body close to the rocks.
- Use the hands to help maintain balance.
- Use large muscles in the legs to support body weight.
- Always maintain three points of contact with the rocks.



Figure 17 Scrambling Technique

Note. From Talisman Newsletter, 2006, *Merry Christmas*, Copyright 2007 by Talisman Mountaineering Activities Scotland. Retrieved April 17, 2007, from <http://www.talisman-activities.co.uk/downloads/newsletters/newsletter4/newsletter4.htm>



When scrambling and facing difficulty, take a moment to catch your breath. Study your route options and always identify a way back.

Boulder Hopping

Boulder hopping is when one uses speed and momentum to lightly hop from boulder to boulder, using arms or trekking poles to for balance.

The following should be considered when boulder hopping:

- Plan your route. Larger boulders are more stable.
- Use hands for stability.
- Keep knees bent and relaxed.
- Control speed. Lightly hop.
- If one begins to lose balance, move forward, stepping lightly from foot to foot until balance is regained.



Figure 18 Boulder Hopping With Trekking Poles

Note. From Great Outdoor, 2006, *Hiking the Forgotten End of the AT*, Copyright 2006 by Greatoutdoor.com. Retrieved April 12, 2007, from <http://www.greatoutdoors.com/go/photos.jsp?title=hikingtheforgottenendoftheat&imag=1>

Scree Crossing

A scree is a mass of fine, small rocks that are often found above the tree line on mountain slopes. When dealing with a scree, caution is the first rule.



Figure 19 Scree

Note. From East Riding of Yorkshire Council, *E Riding Media Library-England North*, Copyright 2007 by School Improvement Service, East Riding of Yorkshire Council. Retrieved April 17, 2007, from http://www.eriding.net/media/england_north.shtml

Traversing a Scree

Traversing means walking obliquely or crossing in a sideways movement.

Walking on a scree may be very slippery. When traversing a scree, a planned zig-zag path is the best option. The route should be broken down in small sections. One should keep the pace controlled and remember that speed can only mean greater risk of injury.

Walking sideways. Walking sideways will provide more contact between the long side of the foot and the slope to give better stability.

Climbing a Scree

One should avoid climbing a scree, if possible as it can be very exhausting. If there is no other option, the following tips should be considered:

- Keep to the sides of the scree. The movement of the scree is slower and larger boulders can be found there.
- Aim to keep feet horizontal. If the scree is small enough, kick the toes into the slope (like in snow).
- Climbing with the feet spread-eagled will help put weight on the instep of each boot.
- Take small steps to reduce the strain on the legs. This also reduces the chances of slipping.
- Legs should be bent at the knee to support the body.

Descending a Scree

When descending a scree, one should keep the weight on the heels and take short steps. One's back should be straight and the knees should be slightly bent to absorb stress and improve balance.

The following should be considered when descending a scree:

- Dig the heels into the slope.
- Use the hands to stay steady.
- Relax the knees and keep moving.

CROSSING WATER OBSTACLES

Rivers

Crossing rivers can be very challenging depending on the time of the year (eg, spring when snow melts into streams and rivers). A plan should be established before crossing a river.

Choose a place to cross. The safest place to cross is where the water is calm and no deeper than the height of one's hips. Such conditions can be found around rivers bends, where the stream widens and slows to make the turn. The darker (and greener) the water, the deeper it is.

The following should be avoided:

- turbulence that causes white water;
- dark water; and
- a powerful current.

If conditions appear dangerous, walk upstream in search of a safer option. Always cross with caution.

Best time to cross. Early in the morning is the best time to cross. Rivers run slower in the morning because the water is colder at night.

Wading across a river. Wading across a river is the safest option. When crossing, always face upstream, diagonal to the current.

If crossing in a group, link arms, with the strongest people at the end. The group should move slowly in a line, diagonal to the current.

Trekking poles can be used to wade across a river. They will help with the balance.



When crossing a river, to keep boots dry, take them off and wear sport sandals. If one does not have sport sandals, remove socks and boot liners, put boots back on and cross the river.

Hopping. Hopping is a technique used with rocks and will help one cross a river and stay dry. The following should be considered when hopping:

- Plan the route. Evaluate the steps to take.
- Decide which rocks are stable.
- Test steps before committing.
- If a step is unstable, move quickly to the next one.

Stepping in the water is an option. It is better to step into the water and get wet feet than to fall into it.

Crossing rivers using a wooden bridge or ropes. Wooden bridges range from constructed bridges to logs placed across a stream. Always test a bridge first to see if it is fixed and stable. Crossing a log should be done one person at a time since weight can dislodge the log. If a bridge or a log is too narrow, unstable or high, shuffle across in a sitting position.



Unless trained in river rescue, hand-held rope should not be used. If a rope is fixed in place, it can be used to hold on to. Avoid getting tangled in the rope. Carabiners shall not be used to attach a person to the rope.

Waterlogged Ground

Avoid crossing waterlogged ground if possible. If there is no other way around, one should plan a route through it. Footsteps of previous trekkers can tell how deep and hard the soil is.

Natural hard spots. When planning a route, aiming for hard spots in the ground can save time. Trees and shrubs might indicate a solid piece of ground. Large rocks and clumps of hard grass are also good indicators.

Trails. Sometimes, trails go across waterlogged ground. Frequently used trails will often have small wooden pathways (looking like short bridges) built to help facilitate the crossing. Bridges made of fallen logs may also be used.



When crossing waterlogged grounds, boots should be tightly laced. Suction of mud may pull at the boots.

Crossing Snow and Ice

Reading the snow for a safe route. When planning a route, it is best to avoid rocky places. Rocks absorb heat causing the snow near them to melt faster. The soft snow may not be firm enough to hold someone's weight. Before using a path, test the snow with trekking poles to prevent injuries. It is best to cross a large snowfield early in the morning when the snow is harder. As the sun rises and becomes more powerful, snow melts unevenly and creates soft spots.

Ascending on snow. When walking on snow, the conditions will govern the route. A new route may be created to ascend safely. Zig-zags may also be an option. If it is easier to go straight up, one should kick the snow several times to make solid steps to stand on. Before standing on these steps, one should always test body weight.



Trekking uphill through snow can be very exhausting. It is recommended to plan twice as much time to complete this kind of trek. Take breaks as required.

Crossing ice. Crossing ice requires caution. When crossing ice, one should use trekking poles to probe for holes or test the snow. On ice, do not rely on old footsteps. The route may not be safe if they are a few days old. Always test before advancing.



Ice is thinner in early winter and spring. During these seasons, one should try to go around.

ACTIVITY

Time: 270 min

OBJECTIVE

The objective of this activity is to have the cadets, in teams of no more than six, hike along a route with some Class 3 terrain, for a distance of 10–15 km.

RESOURCES

- Expedition field pack,
- Personal equipment,
- Hiking equipment, to include:
 - hiking boots (one pair per cadet),
 - day pack (one per cadet),
 - water carrier (one per cadet), and
 - trekking poles (two poles per cadet);
- Topographical / trail map of the area (two per team),
- Compass (one per team),
- Whistle (one per cadet),
- Communication device (two per team),

- GPS Receiver (one per team),
- Batteries (spares for hand-held radio and GPS), and
- First aid kit (one per team).

ACTIVITY LAYOUT

Designate a hiking route with some Class 3 terrain.

ACTIVITY INSTRUCTIONS

1. Conduct a briefing, to include an explanation of:
 - a. the objectives and importance of the activity;
 - b. the resources that may be required to perform the activity; and
 - c. any safety guidelines that must be followed while performing the activity.
2. Have the cadets, in teams of no more than six, hike along a route with some Class 3 terrain, for a distance of 10–15 km during an expedition to practice:
 - a. executing the "rest step"; and
 - b. employing proper techniques to:
 - (1) hop boulders (as applicable),
 - (2) cross scree (as applicable), and
 - (3) cross a water obstacle (as applicable).
3. Conduct a debriefing by asking the cadets:
 - a. how they felt about the activity,
 - b. how they felt their team worked together;
 - c. what portion of the activity challenged them the most;
 - d. how their teammates assisted them when they were challenged;
 - e. if there are any specific examples of when their team bonded;
 - f. how the team made decisions;
 - g. whether or not all team members ideas / suggestions were considered; and
 - h. what they would do as a leader of this type of activity to ensure their subordinates enjoyed the experience.

SAFETY

- The cadets will respect the predetermined boundaries for this activity.
- Teams will travel in single file.
- Teams will not pass another teams / groups unless directed to do so by their team instructor.

- All the cadets must carry 1 L of water.
- A water supply will be available along the route.

CONFIRMATION OF TEACHING POINT 1

The cadets' participation in hiking along a route will serve as the confirmation of this TP.

END OF LESSON CONFIRMATION

The cadets' participation in the expedition will serve as the confirmation of this lesson.

CONCLUSION

HOMEWORK / READING / PRACTICE

Nil.

METHOD OF EVALUATION

This EO is assessed IAW A-CR-CCP-704/PG-001, *Gold Star Qualification Standard and Plan*, Chapter 3, Annex B, 426 PC.

CLOSING STATEMENT

Hiking is one of three dynamic modes of transport that can be used during expedition training. It is critical that the cadets are given the opportunity to hike on routes which include some Class 3 terrain to prepare them for more advanced expedition experiences. Being aware of pacing and implementing the "rest step" while hiking will ensure a more enjoyable hiking experience for the individual and the team / group. When travelling on advanced hiking terrain, the possibility of encountering obstacles is quite great, therefore it is important that all members understand how to safely cross them.

INSTRUCTOR NOTES / REMARKS

Expedition centres are required to select two dynamic modes of travel from EO M426.02a (Paddle a Canoe), EO M426.02b (Ride a Mountain Bike), and EO M426.02c (Hike Along a Route) EO M426.02d (Snowshoe Along a Route) and EO M426.02e (Ski Along a Route) to incorporate into the expedition training.

This EO has been allocated nine periods in the overall course period allocation. Each expedition centre may adjust this allocation to reflect the choice of activities, facilities and available resources at the expedition centre.

Upon arrival at the expedition centre, cadets will be broken into teams. These teams will remain the same for the duration of the expedition.

IAW A-CR-CCP-951/PT-002, *Royal Canadian Army Cadets Adventure Training Safety Standards*:

1. hiking equipment includes:
 - hiking boots, and
 - trekking poles; and

2. the following group hiking equipment is required when hiking:

- topographical / trail map of area as required,
- compass,
- GPS receiver.
- first aid kit, and
- communication device (eg, cellular phone or hand-held radio).

The intensity level of the activity shall follow the progression matrix outlined in A-CR-CCP-951/PT-002, *Royal Canadian Army Cadets Adventure Training Safety Standards*.

Ensure that each cadet has an ample supply of water when hiking.

REFERENCES

A2-001 A-CR-CCP-951/PT-002 Director Cadets 3. (2006). *Royal Canadian Army Cadets adventure training safety standards*. Ottawa, ON: Department of National Defence.

C2-016 ISBN 1-4000-5309-9 Curtis, R. (2005). *The backpacker's field manual: A comprehensive guide to mastering backcountry skills*. New York, NY: Three Rivers Press.

C2-042 ISBN 0-7566-0946-1 Berger, K. (2005). *Backpacking & hiking*. New York, NY: DK Publishing, Inc.

C2-051 ISBN 978-0-7153-2254-3 Bagshaw, C. (Ed.). (2006). *The ultimate hiking skills manual*. Cincinnati, OH: David & Charles.

C2-103 ISBN 0-89886-427-5 Graydon, D., & Hanson, K. (Eds.). (2001). *Mountaineering: The freedom of the hills* (6th ed.). Seattle, WA: The Mountaineers.

THIS PAGE INTENTIONALLY LEFT BLANK



ROYAL CANADIAN ARMY CADETS

GOLD STAR

INSTRUCTIONAL GUIDE



SECTION 5

EO M426.02d – SNOWSHOE ALONG A ROUTE

Total Time:

270 min

PREPARATION

PRE-LESSON INSTRUCTIONS

Resources needed for the delivery of this lesson are listed in the lesson specification located in A-CR-CCP-704/PG-001, *Gold Star Qualification Standard and Plan*, Chapter 4. Specific uses for said resources are identified throughout the instructional guide within the TP for which they are required.

Review the lesson content and become familiar with the material prior to delivering the lesson.

PRE-LESSON ASSIGNMENT

Nil.

APPROACH

An interactive lecture was chosen for TP 1 to introduce and give direction on the types of snow that may be encountered when snowshoeing.

A demonstration and performance was chosen for TPs 2 and 3 as it allows the instructor to explain and demonstrate the procedure for fitting snowshoes and executing snowshoe techniques while providing an opportunity for the cadet to practice the skills.

INTRODUCTION

REVIEW

Nil.

OBJECTIVES

By the end of this lesson the cadet shall have practiced snowshoe techniques along a route.

IMPORTANCE

It is important for cadets to snowshoe along a route by using different snowshoe techniques so they will be prepared for the technical challenges, when given the opportunity to participate in more advanced level expeditions. Snowshoeing along a trail or predetermined route requires the individual to be aware of their surroundings, their limitations and the limitations of the group they are travelling with. Knowing different types of snow conditions provides the snowshoer with the information to make a decision as to whether the snow conditions are safe enough to continue.

Teaching Point 1**Discuss types of snow.**

Time: 10 min

Method: Interactive Lecture



Cadets will be expected to snowshoe for a distance of 8–10 km. While travelling, it is possible to travel across many different types of snow. Being aware of what type of snow one is travelling on will help to increase awareness of how their footing will react to the condition of the snow.

If cross-country skiing was chosen as a mode of travel and was instructed prior to this EO, types of snow have already been discussed. If that is the case, conduct a quick review bringing attention to how snow can affect snowshoeing.

Point out examples of different types of snow that exist in the surrounding environment.

TYPES OF SNOW

Snow and ice conditions change with heating and cooling, and are largely affected by the weather. With a change in conditions speed of travel may be affected.

New fallen snow. Very loose and light. The snowflakes still have multiple branches. If new snow is dry, it is feathery; if damp, it quickly consolidates into a stage of settled snow. When this snow is damp, it can be difficult to snowshoe on. When dry and fluffy, this snow is easy to snowshoe on.

Powder snow. New, untouched freshly fallen soft snow. It can give the feeling of floating in a weightless environment. Powder snow can be packed in thick layers that form a natural pillow. Powder snow has a low moisture content, as almost 97 percent of it is air. In coastal regions, where there is higher humidity, the snow is heavier than in a continental region. Powder snow compacts easily, supporting the weight of the snowshoer. This is a good type of snow to snowshoe on.

Wind-packed snow. Snow blown from one direction, compacted by the force of the wind. Wind-packed snow is created by the pressure exerted by wind, causing a form of cold-heat hardening. In some areas, the snow surface is strong enough to hold the weight of a person on snowshoes. This snow is good to snowshoe on.

Sun crust snow. Snow that has had the upper layer melt and then refreeze. Usually on top of powder snow, sun crust snow is stronger than the powder snow below it due to the refreezing. This snow can be dangerous to snowshoe on if on a slope; the crust may give and a person may lose their footing. Snowshoeing on a flat surface over sun crust snow can be difficult as the snowshoe breaks through the crust and can hook into the crust on the return. The constant hooking and breaking in sun crusted snow can tire the snowshoer.



Sun crust snow is not very stable on a slope and can be dangerous when weighted. The snow will give way causing a fall or a slide.

Corn snow. After thawing, corn snow occurs. The structure of the snow is very grainy at this point. Corn snow usually occurs in the spring, and can be strong enough to carry weight but it also can indicate the presence of rotten snow, which is very dangerous. Corn snow is produced during the cycle of melting and refreezing in the accumulated snow. Caution should be taken when snowshoeing on this type of snow, especially in mountainous or hilly terrain.



A layer of snow that has been sun crusted will become corn snow.

Rotten snow. Caused by repeated melting and freezing and is found mostly on the south side of hills, or in lower levels of snow. Water will seep to the lower layers and will not freeze because it is insulated from the weather by the covering snow layer. Rotten snow can resemble very small icicles, or candle ice. This snow is dangerous. Sudden drops may exist and holes develop under the surface of the snow. Falling and injury are highly possible.

Slush snow. When the air temperature becomes warmer than the freezing point, the snow begins to melt and the water content becomes high. Slush snow absorbs water from melting snow. Slush snow is recognizable by depressions in the snow with darker or bluish snow areas. These areas show holes in the ice or an accumulation of water on the surface of the ice. Snowshoeing on this type of snow can be dangerous since the chance of stepping into a large puddle or slipping by loss of traction exists.

CONFIRMATION OF TEACHING POINT 1

QUESTIONS:

- Q1. What type of snow is loose and light?
- Q2. Describe wind-packed snow.
- Q3. What is rotten snow?

ANTICIPATED ANSWERS:

- A1. New fallen snow is loose and light.
- A2. Snow blown from one direction, compacted by the force of the wind. Wind-packed snow is created by the pressure exerted by wind, causing a form of cold-heat hardening. In some areas, the snow surface is strong enough to hold the weight of a person on snowshoes. This snow is good to snowshoe on.
- A3. Rotten snow is snow found on the south side of hills, or in lower levels of snow. It is caused by repeated melting and freezing.

Teaching Point 2

Explain, demonstrate and have the cadets fit personal snowshoe equipment.

Time: 15 min

Method: Demonstration and Performance



For this TP it is recommended that instruction take the following format:

1. Explain the importance of selecting and properly fitting snowshoe equipment.
2. Explain and demonstrate the selection of snowshoe size and how size affects carrying capacity.
3. Have cadets select and size snowshoes.
4. Explain, demonstrate and have the cadets fit snowshoe bindings.
5. Explain, demonstrate and have the cadets select and properly size poles.
6. Once each cadet has selected snowshoe equipment, label all equipment with masking tape.

Note: Assistant instructors may be used to monitor the cadets' performance.



The standard snowshoe may vary between expedition centres. Check the manufacturers' specifications for sizing and holding capacity.

SNOWSHOES

Snowshoe size is dictated by a person's total weight including body, pack, boots, and clothing.

Parts of a Snowshoe

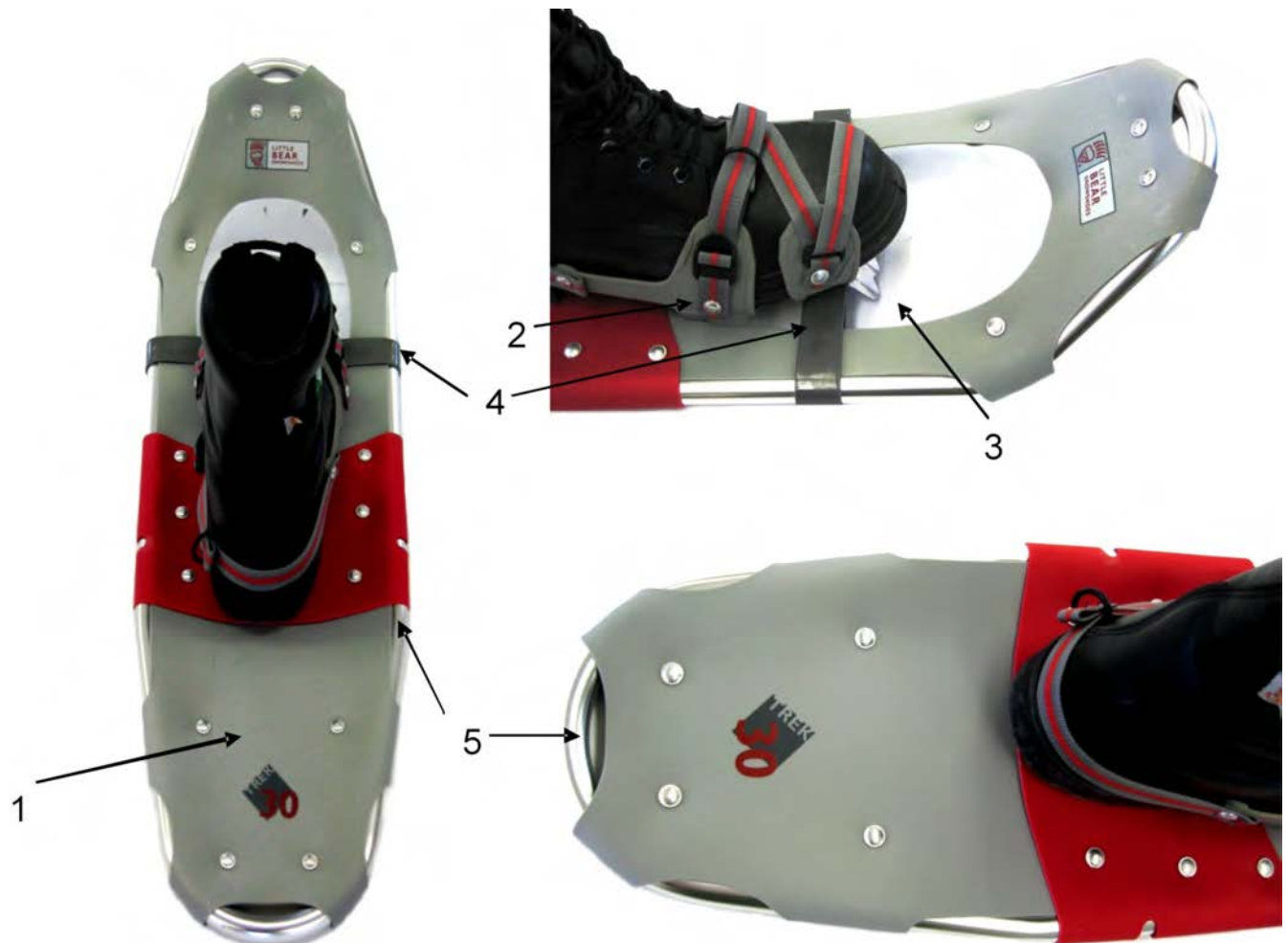

Figure 1 Parts of a Snowshoe

Note. Created by Director Cadets 3, 2009, Ottawa, ON: Department of National Defence.

1. **Deck.** The part of the snowshoe that supports a person's weight on the snow. It can be webbed or solid and is made from a variety of materials depending on the manufacture.
2. **Binding.** Connects the boot to the snowshoe. When worn, the bindings should be secure but comfortable.
3. **Crampon.** Attached below the pivot point. When weighted, the crampon digs into the surface below it and provides traction to the snowshoer.
4. **Pivot point.** Allows the foot to rotate with a natural arc when walking. To engage the crampon, rotate the pivot point forward with pressure from the ball of the foot—this provides more traction when digging into the surface below.
5. **Frame.** This is the part of the snowshoe that makes up the skeletal shape. It can be made of metal or wood and functions as the seat for the bindings and crampons. A snowshoe with a strong frame will last a long time.

Selecting Snowshoes

The chart below is a rough guide to follow when in a standard condition of wet powder snow.



If in between weight categories:

- Select the smaller snowshoe if expecting to encounter heavy snow.
- Select the larger snowshoe if travelling through deep backcountry powder.

| Snowshoe Size | Carrying Capacity |
|--------------------------------------|-------------------|
| 20 cm by 56 cm (8 inch by 22 inch) | 68 kg (150 lbs) |
| 20 cm by 63 cm (8 inch by 25 inch) | 90 kg (200 lbs) |
| 22 cm by 43 cm (9 inch by 34 inch) | 113 kg (250 lbs) |
| 24 cm by 86 cm (9.5 inch by 36 inch) | 136 kg (300 lbs) |

The smaller the snowshoe, the better it will be for climbing over blow downs (fallen trees and bushes) and through brush. The larger the snowshoe, the better flotation on top of snow.

BINDINGS

The binding attaches the foot to the snowshoe securely, preventing the heel from sliding from side to side, even when travelling across a slope. Bindings most often fit a wide range of boots sizes. In any category of snowshoe, the binding should be made of hardy, flexible rubberized nylon straps, with buckles that do not loosen or freeze and are easily manipulated even when wearing mittens. The bindings must not be fastened too tightly where circulation may be cut off, as the chances of frostbite will increase.



During rest breaks, bindings should be checked for fit and possible readjustment.



Types of bindings include:

Fixed rotation. Lifts the snowshoe tail up with the foot. These tend to throw snow onto the snowshoer's back, but are better when climbing over forest obstacles.

Free rotation. Will not lift the snowshoe tail up with the foot. The extended tails may get hung up in vegetation or downed trees. Military issue snowshoes have free rotation bindings.



The binding on most snowshoes connects to the pivot point.



Snowshoe bindings may be different at each expedition centre. The following guide to fit bindings is a description on how military issued bindings are fitted. When using civilian bindings, check the manufacturers' specifications and present those instructions to the cadets.



It is much easier to make binding adjustments when not wearing the snowshoes.

Adjusting the Binding (Harness)

Snowshoe bindings (harnesses) need to be adjusted to fit the boot / mukluks. Improper fit can result in a snowshoe falling off on the trail and poor foot placement on the snowshoes. Bindings (harnesses) should hinge freely up and down, with the toe of the boot / mukluk fitting through the toe hole in the snowshoe and the ball of the foot directly over the toe cord.

Adjust the Bindings (Harnesses) to the Boot / Mukluk

1. Resize the toe strap by undoing the tie down strap from the tie down buckle.
2. Reweave the tie down strap through the webbing on the snowshoe to either loosen or tighten the toe strap to the size of the mukluk.
3. Fasten the tie down strap through the tie down buckle.

To prevent the toe strap from slipping up over the toe of the mukluk, the toe strap should be tied down to the front mesh of the snowshoe using a 20-cm piece of heavy duty twine.

Attaching the Snowshoe to the Boot / Mukluk

1. Position the boot / mukluk in the toe strap, with the cross strap under the instep.
2. Bring the inside part of the side strap back diagonally up over the heel and around the outside of the boot / mukluk (as illustrated in Figure 2).

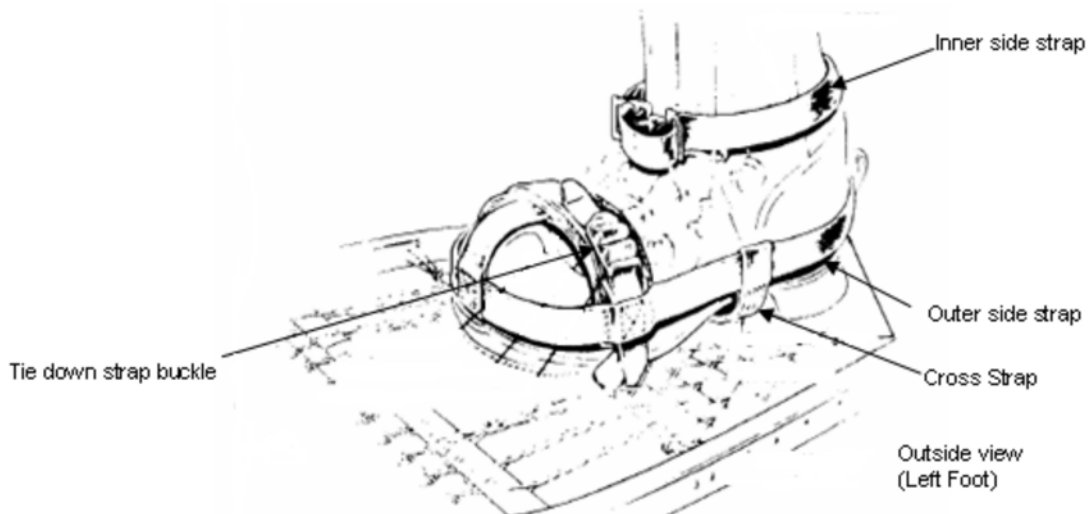

Figure 2 Attaching Harness to the Boot / Mukluk

Note. From *Arctic and Sub Arctic Operations Volume 2 Basic Cold Weather Training* (p. 5-44), by Chief of the Defence Staff, 1974, Ottawa, ON: Department of National Defence. Copyright 1975 by Department of National Defence.

3. Bring the outside part of the side strap back and around the lower part of the heel, around the inside of the boot / mukluk, crossing over the inner side strap, with the buckle located over the boot / mukluk laces, as illustrated in Figure 3.

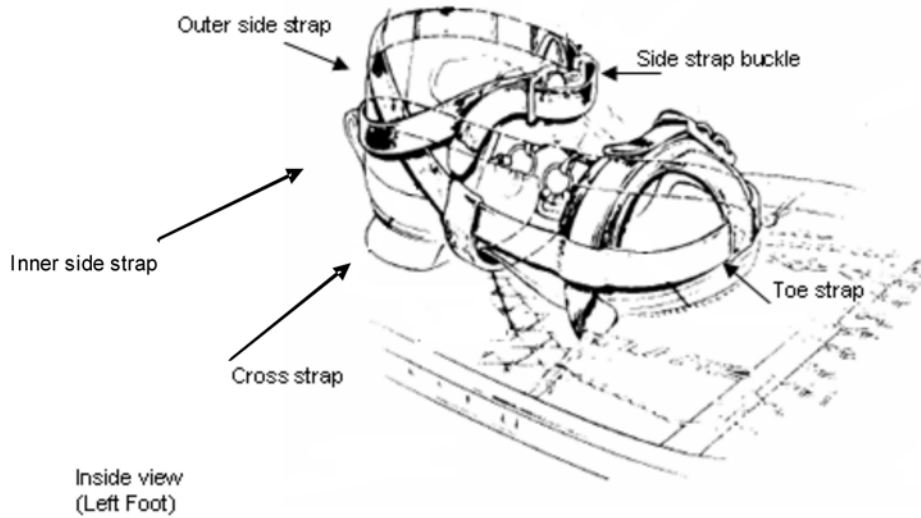

Figure 3 Attaching Harness to a Boot

Note. From *Arctic and Sub Arctic Operations Volume 2 Basic Cold Weather Training* (p. 5-45), by Chief of the Defence Staff, 1974, Ottawa, ON: Department of National Defence. Copyright 1975 by Department of National Defence.

POLES

Telescoping trekking poles are the most versatile choice for snowshoeing. These poles provide better balance and reduce the amount of stress on the knees, shoulders and back. They absorb some of the impact the body would otherwise absorb. The poles, rather than the body, absorb shock, reduce arm and leg fatigue and improve endurance. While snowshoeing, they help a person keep balance while climbing inclines or when backing out of an area in deep snow. Although trekking poles are generally not required when snowshoeing, they are a helpful accessory.



Figure 4 Telescoping Trekking Pole

Note. From Wintergoodies.com, 2007, *Hiking, Trekking & Walking Pole Adjustable*, Copyright 2007 by Wintergoodies.com. Retrieved April 12, 2007, from http://www.winterbrookgoodies.com/pd_swissgear_hiking_trekking_walking_pole.cfm

Sizing a Pole

Sizing poles to fit a snowshoer requires the user to stand up straight and hold the pole close to the body. The pole when held upright should come to a height in-between the middle of the chest and slightly below the armpit. Adjust the trekking pole accordingly until it is sized to the snowshoer.

CONFIRMATION OF TEACHING POINT 2

The cadets' fitting of personal snowshoe equipment will serve as the confirmation of this TP.

Teaching Point 3

Explain, demonstrate and have the cadets practice snowshoe techniques along a route.

Time: 235 min

Method: Demonstration and Performance



Cadets shall be given detailed instruction on how to complete each snowshoe technique.

For each technique explain, demonstrate and have the cadets practice the movement.

Cadets shall perform each technique at a level of proficiency that will allow successful completion of the route to be travelled prior to departing.

SNOWSHOE TECHNIQUES

Snowshoeing is a very easy skill to learn. People can immediately walk on snowshoes even if they have never worn them before. However, there are techniques that will greatly improve these abilities while snowshoeing over snow-covered terrain.

Striding

To conserve energy when snowshoeing on soft snow, lift the snowshoe to clear the snow and thrust forward to complete each pace.

The rest step allows for momentary pauses between steps. With practice, one can adjust the length of the pause to the state of fatigue. As one steps forward, thrust the front snowshoe out and let it plop down, or stamp it firmly into place. Straighten and lock the rear knee joint so the tendons and cartilage are holding weight and pause and relax the thigh muscles, using the poles to maintain balance. Bring the rear leg ahead, thrust the snowshoe out, place it, lock what is now the rear leg, relax momentarily and repeat.

The effect is to rest the legs during the time they are actually working hard. A couple of seconds of work with a couple of seconds of rest make it possible to keep going steadily without long stops.



Novice snowshoers have a tendency to look down at the snowshoes when they walk. They will adapt more quickly to snowshoeing if they keep their head and eyes up, and look forward, down the trail.

Executing Kick Turns



Kick turns are performed when conditions exist where there is not enough room to perform a normal 180-degree stepping turn. Remind cadets to always assess the area and perform a normal 180-degree stepping turn when they can; it is safer and less accidental falls and twists will occur.

Kick turns are performed when a change in direction is required. It is commonly used in an enclosed area along the trail. The steps in performing a kick turn are:

1. Lift one leg and swing it back, and then kick it forward and upward.
2. At the top of the kick, just as the tail of the snowshoe clears the snow, turn the foot 180 degrees.
3. Lower and plant the foot in the snow, with the front of the foot facing to the rear.
4. Shift the body weight to the foot facing 180 degrees to the rear and then lift the other foot.
5. Bring the foot over the trailing edge of the planted snowshoe and face the new direction.

Crossing Obstacles

Obstacles such as fallen trees, logs, tree stumps, ditches and small streams can be stepped over. Care must be taken not to place too much strain on the snowshoe ends by bridging a gap, since the frame may break. In shallow snow, there is a danger of catching and tearing the webbing on tree stumps or snags that are only slightly covered.

Never bridge two obstacles together with the snowshoes. When jumping over obstacles do not let the tails of the snowshoes fall downward. If the tail of the snowshoe is vertical upon landing, it will strike the snow first and may result in a fall. When possible, find an alternate route around the obstacle.



Bridging. When the toe and tail of the snowshoe are placed on two elevated objects and the entire weight of the snowshoer is fitted on the webbing of the snowshoe.



Figure 5 Bridging

Note. From *Snowshoeing: From Novice to Master* (p. 46), by G. Prater, 2002, Seattle, WA: The Mountaineers Books. Copyright 2002 by The Mountaineers Books.

Ascending Hills

The method chosen to walk uphill will depend on the angle of the incline and the condition of the snow. The following techniques can be used when navigating uphill.

Step kick. When going straight up a hill, this is the most efficient method on firm or hard packed snow where traction is not a concern. Kick the toe of the snowshoe in the snow ensuring that it is firmly planted before shifting weight to the snowshoe.

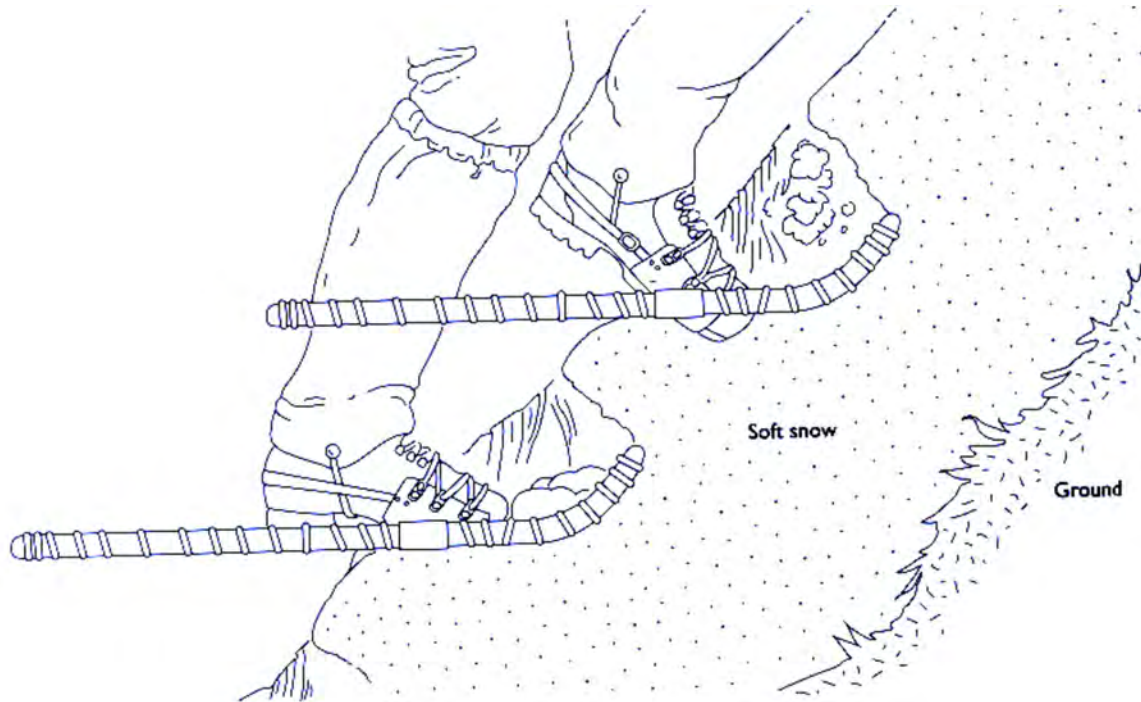

Figure 6 Step Kick

Note. From *Snowshoeing: From Novice to Master* (p. 114), by G. Prater, 2002, Seattle, WA: The Mountaineers Books. Copyright 2002 by The Mountaineers Books.

Edging. Performed by simply kicking the snowshoe sideways into the slope, or moving the boot heel as far toward the uphill side of the slope as possible. Stamp the snowshoe down, forcing the outside edge of the snowshoe into the slope. When edging, the body will be perpendicular to the slope. It is used when walking up a steep slope.



Figure 7 Edging

Note. From *Snowshoeing: From Novice to Master* (p. 113), by G. Prater, 2002, Seattle, WA: The Mountaineers Books. Copyright 2002 by The Mountaineers Books.

Switchbacking. Used to travel a slope that is fairly steep and is covered in deep powder snow. Ascend the hill by walking across the slope at an angle that is comfortable and not steep enough to allow the snowshoes to slip. To turn back (switchback) to the right, firmly stamp the left snowshoe in the snow and make sure it will hold. Shift the weight to the left foot, face the slope, and then swing the right snowshoe around to point it in the direction of the next switchback and firmly stamp it into the snow. Ensure that the tail of the right snowshoe is not placed on the left snowshoe. Stamp the right web into the snow and gently shift the body weight and step on it. To make a left turn, reverse the procedure.

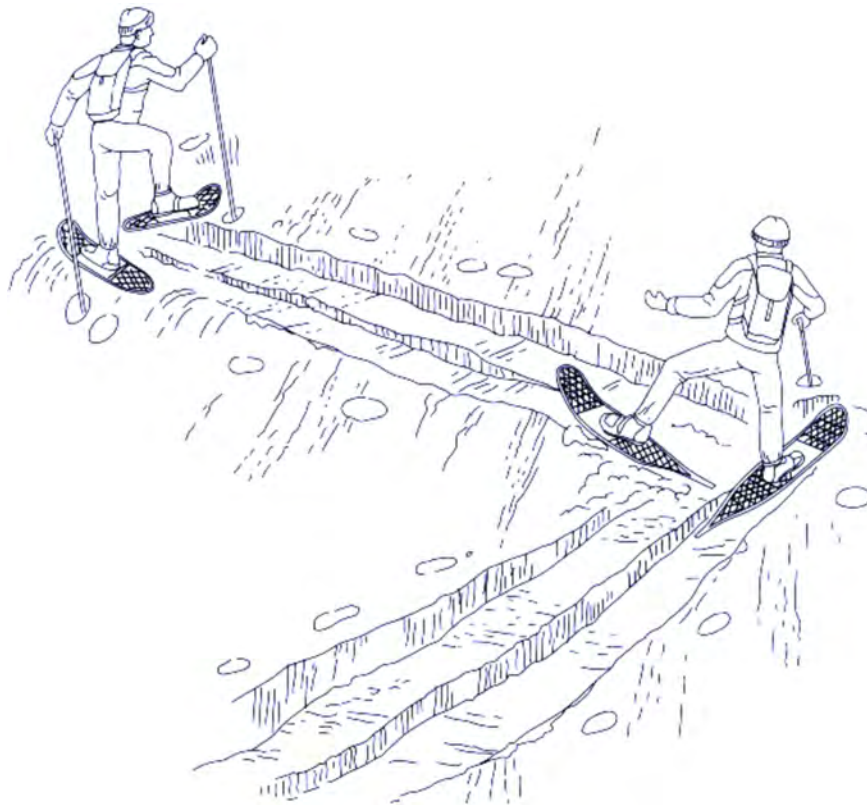

Figure 8 Switchbacking

Note. From *Snowshoeing: From Novice to Master* (p. 110), by G. Prater, 2002, Seattle, WA: The Mountaineers Books. Copyright 2002 by The Mountaineers Books.

Descending Hills

The method that is chosen to walk downhill will depend on the angle of the incline and the condition of the snow. The same techniques for ascending hills are used to descend. When descending a hill a person should follow the following guidelines:

- Do not lean forward by bending at the waist. This is a normal tendency for beginners and will increase the chance of falling forward.
- Avoid leaning back on the snowshoes, as if digging in the heels. This will increase the chance of the snowshoes sliding out from under the snowshoer.
- To assume a safe posture, stand straight up; balance the body straight over the foot; and slightly bend the knees to compensate for changes, and then relax.

Breaking Snow

In loose snow, the trailbreaker may have several extra pounds of snow on the snowshoes. The snow falls on top of the webbing when walking and sinking in deep snow. This extra weight will exhaust the trailbreaker at a faster rate than the followers. When the trailbreaker feels they can no longer move forward at a progressive pace, they should step to the side and drop to the rear as the rest of the party moves past.



Trailbreakers, depending on the depth of the snow and the terrain being covered should only break trail for 2–5 minutes.

ACTIVITY

Time: 200 min

OBJECTIVE

The objective of this activity is to have the cadets, in teams of no more than six, snowshoe along a route for 8–10 km with an expedition field pack, to include:

- adjusting stride;
- performing a kick-turn;
- crossing obstacles applicable to the terrain;
- ascending a hill;
- descending a hill; and
- breaking snow.

RESOURCES

- Personal expedition equipment,
- Personal snowshoe equipment,
- Group snowshoe equipment, and
- Water carrier (one per cadet).

ACTIVITY LAYOUT

Nil.

ACTIVITY INSTRUCTIONS

1. Conduct a briefing to include an explanation of:
 - a. the objectives and importance of the activity,
 - b. the resources that may be required to perform the activity, and
 - c. any safety guidelines that must be followed while performing the activity.
2. Have the cadets retrieve their snowshoes and packs.
3. Have the cadets put on their snowshoes and packs.

4. Have the cadets, in teams of no more than six, snowshoe with an expedition field pack, following the designated route for a distance of 8–10 km during an expedition to practice:
 - a. adjusting stride;
 - b. performing a kick-turn;
 - c. crossing obstacles applicable to the terrain;
 - d. ascending a hill;
 - e. descending a hill; and
 - f. breaking snow.
5. Upon arrival at the end point, have the cadets remove, clean and inspect snowshoes for damage and then properly store / return all equipment.
6. Conduct a debriefing by asking the cadets:
 - a. how they felt about the activity;
 - b. how they felt their team worked together;
 - c. what portion of the activity challenged them the most;
 - d. how their teammates assisted them when they were challenged;
 - e. if there are any specific examples of when their team bonded;
 - f. how the team made decisions;
 - g. whether or not all team members ideas / suggestions were considered; and
 - h. what they would do as a leader of this type of activity to ensure their subordinates enjoyed the experience.

SAFETY

- Each team will be led by the assigned team leader.
- The Team Instructor(s) (TI) must be in sight or sound of the team at all times.
- In areas of complex / technical terrain TI(s) will demonstrate requisite skills as required.
- Teams will travel separately on the same trail.
- There will be a minimum of 500 m between teams at all times.
- Cadets must travel in single file at all times.
- Cadets must have at least 1 L of water.
- Water resupply points will be located along the route.
- Meals will be provided at a predetermined location(s) and detailed in the route instructions.

CONFIRMATION OF TEACHING POINT 3

The cadets' participation in the activity will serve as the confirmation of this TP.

END OF LESSON CONFIRMATION

The cadets' participation in snowshoeing along a route will serve as the confirmation of this lesson.

CONCLUSION

HOMEWORK / READING / PRACTICE

Nil.

METHOD OF EVALUATION

This EO is assessed IAW A-CR-CCP-704/PG-001, *Gold Star Qualification Standard and Plan*, Chapter 3, Annex B, 426 PC.

CLOSING STATEMENT

Snowshoeing is one of the dynamic modes of transport that can be used during expedition training. It is critical that the cadets are given the opportunity to practice snowshoe techniques along designated routes to prepare them for more advanced snowshoeing experiences. Being aware of sharing the trailbreaking task and implementing the rest step while snowshoeing will ensure a more enjoyable snowshoeing experience for the individual and the team / group. When travelling the possibility of encountering obstacles is quite great, so it is important that all members understand how to safely cross them.

INSTRUCTOR NOTES / REMARKS

Expedition centres are required to select two dynamic modes of travel from EO M426.02a (Paddle a Canoe), EO M426.02b (Ride a Mountain Bike), EO M426.02c (Hike Along a Route), EO M426.02d (Snowshoe Along a Route) and EO M426.02e (Ski Along a Route) to incorporate into the expedition training.

This EO has been allocated nine periods in the overall course period allocation. Each expedition centre may adjust this allocation to reflect the choice of activities, facilities and available resources at the expedition centre.

Upon arrival at the expedition centre, cadets will be divided into teams. Cadets will be given an opportunity to navigate and lead peers. These teams will remain the same for the duration of the weekend.

Total distance for the snowshoe route can be adjusted depending on terrain and level of skill of participants.

The following equipment is required when snowshoeing:

1. personal snowshoe equipment, to include:
 - a. snowshoes,
 - b. bindings,
 - c. poles,
 - d. whistle, and
 - e. appropriate cold-weather clothing; and
2. group snowshoe equipment, to include:
 - a. topographical / trail map of area as required,
 - b. compass,

- c. first aid kit,
- d. communication device (eg, cellular phone or hand-held radio),
- e. GPS receiver, and
- f. cold weather emergency kit appropriate to the activity.

IAW A-CR-CCP-951/PT-002, *Royal Canadian Army Cadets Adventure Training Safety Standards* weather must be continuously assessed. Training should cease and cadets must be brought inside if the temperature gets too low (consider wind chill).

REFERENCES

C2-004 ISBN 1-896713-00-9 Tawrell, P. (1996). *Camping and wilderness survival: The ultimate outdoors book*. Green Valley, ON: Author.

C2-248 ISBN 978-0-89886-891-3 Prater, G. (2002). *Snowshoeing: From novice to master*. Seattle, WA: The Mountaineers Books.



ROYAL CANADIAN ARMY CADETS

GOLD STAR

INSTRUCTIONAL GUIDE



SECTION 6

EO M426.02e – SKI ALONG A ROUTE

Total Time:

270 min

PREPARATION

PRE-LESSON INSTRUCTIONS

Resources needed for the delivery of this lesson are listed in the lesson specification located in A-CR-CCP-704/PG-001, *Gold Star Qualification Standard and Plan*, Chapter 4. Specific uses for said resources are identified throughout the instructional guide within the TP for which they are required.

Review the lesson content and become familiar with the material prior to delivering the lesson.

Organize all cross-country ski equipment into three groups—skis, boots, and poles. Within each group organize the equipment by size / height.

Photocopy one Cross-Country Ski Equipment Sizing Information Form located at Attachment A and cut it into four separate forms.

Assistant instructors will be required for this lesson.

PRE-LESSON ASSIGNMENT

Distribute to the cadet the Cross-Country Ski Equipment Sizing Information Form located at Attachment A to cadets when they arrive at the expedition centre on the Friday evening. Cadets must complete the form prior to the commencement of this EO.

Cadets must arrive wearing appropriate cold weather clothing. They must have the socks on that they will be wearing during the expedition, to ensure proper fit of ski boots.

APPROACH

An interactive lecture was chosen for TP 1 to introduce and give the cadet direction on types of snow and how they can affect a cross-country skier.

A demonstration and performance was chosen for TPs 2 and 3 as it allows the instructor to explain and demonstrate the procedures for fitting personal cross-country ski equipment and executing classic cross-country ski techniques while providing an opportunity for the cadet to practice the skill.

INTRODUCTION

REVIEW

Nil.

OBJECTIVES

By the end of this lesson the cadet shall have classic cross-country skied along a route for 6–10 km, during an expedition.

IMPORTANCE

It is important for cadets to classic cross-country ski along a route, as it is a mode of travel used during winter expedition training. Cadets are required to work as a member of a team to travel a significant distance during the expedition. Performing classic cross-country ski techniques assists them in keeping up with their team.

Teaching Point 1**Discuss types of snow.**

Time: 10 min

Method: Interactive Lecture



The purpose of this TP is to introduce the cadets to the different types of snow they may encounter when cross-country skiing.

If snowshoeing was chosen as a mode of travel and was instructed prior to this EO, types of snow have already been discussed. If that is the case, conduct a quick review bringing attention to how the different types of snow can affect the slide and grip of skis.

Point out examples of different types of snow that exist in the surrounding environment.

Being aware of what type of snow or ice one is travelling on increases awareness of how skis perform in different conditions.

TYPES OF SNOW

Skis do not slide on the snow; they slide on a thin layer of moisture (2) that is between the snow (3) and the ski surface (1). The thin layer of moisture is created by the pressure of the ski upon the snow and by the friction caused by the motion of the skis across the snow. Heat created by the pressure and the friction melts some of the snow.

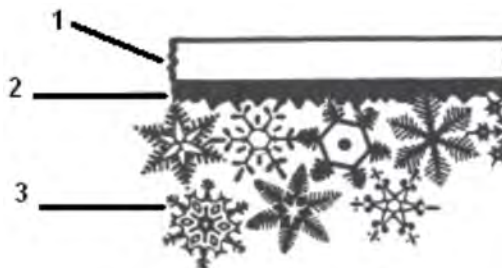

Figure 1 Relationship Between Snow, Moisture and the Cross-Country Ski

Note. From *Complete Cross-Country Skiing and Ski Touring* (2nd ed.), (p. 164), by W. J. Lederer & J. P. Wilson, 1970, Toronto, ON: George J. McLeod Ltd. Copyright 1970 by William J. Lederer and Joe Pete Wilson.

Skis also have to grip the snow to allow the skier to push and move forward while going uphill or on flat terrain. This grip is influenced by the type of snow crystals (flakes).

New snow crystals (flakes), with their numerous points and arms, dig into the uneven surface of the waxed ski when there is weight pushing down on them.



Figure 2 New Snow Crystals (Flakes)

Note. From *Complete Cross-Country Skiing and Ski Touring* (2nd ed.) (p. 164), by W.J. Lederer & J.P. Wilson, 1970, Toronto, ON: George J. McLeod Ltd. Copyright 1970 by William J. Lederer and Joe Pete Wilson.

Old snow crystals (flakes), 24–36 hours old, begin to wear away, making them smoother and less able to grip into the ski. Once snow crystals (flakes) begin to melt, or melt and then re-freeze, the points and arms become virtually non-existent, severely affecting how the skis slide on and grip the snow.



Figure 3 Old Snow Crystals (Flakes)

Note. From *Complete Cross-Country Skiing and Ski Touring* (2nd ed.) (p. 166), by W.J. Lederer & J.P. Wilson, 1970, Toronto, ON: George J. McLeod Ltd. Copyright 1970 by William J. Lederer and Joe Pete Wilson.

The action of skis both sliding and gripping the snow is made possible by wax. Wax selection is influenced by:

- the moisture content in the snow,
- the temperature of the air,
- the shape of the snow crystals (flakes), and
- the age / type of snow.

In new snow, the layer of wax should be smooth and thin. In older snow, the layer of wax should be sticky and thick.

Being able to identify different types of snow is very important for cross-country skiers. The type of snow dictates the type / level of wax required for optimum skiing.



Cadets are not required to wax their own skis. This will be completed by an experienced staff member. They should, however, be able to tell the staff member what type of snow they will be skiing on.

New fallen snow. Very loose and light. The snowflakes still have multiple points / arms. If new snow is dry, it is feathery; if damp, it quickly consolidates into a stage of settled snow.

Powder snow. New, untouched freshly fallen soft snow. It can give the feeling of floating in a weightless environment. Powder snow can be packed in thick layers that form a natural pillow. Powder snow has a low moisture content, as almost 97 percent of it is air. Powder snow compacts easily.

Wind-packed snow. Snow blown from one direction, compacted by the force of the wind. Wind-packed snow is created by the pressure exerted by wind, causing a form of cold-heat hardening. In some areas the snow surface is strong enough to hold the weight of a person on skis.

Sun crust snow. Snow that has had the upper layer melt and then refreeze. Usually on top of powder snow, sun crust snow is stronger than the powder snow below it due to the refreezing. This snow can be dangerous as the crust may give away causing the skier to lose their grip.



Sun crust snow is not very stable on a slope and can be dangerous when weighted. The snow will give way causing a fall or a slide.

Corn snow. After thawing, corn snow occurs. The structure of the snow is very grainy at this point. Corn snow usually occurs in the spring, and can be strong enough to carry weight but it also can indicate the presence of rotten snow, which is very dangerous. Corn snow is produced during the cycle of melting and refreezing in the accumulated snow.



A layer of snow that has been sun crusted will become corn snow.

Rotten snow. Caused by repeated melting and freezing and is found mostly on the south side of hills, or in lower levels of snow. Water will seep to the lower layers and will not freeze because it is insulated from the weather by the covering snow layer. Rotten snow can resemble very small icicles, or candle ice. This snow is dangerous. Sudden drops may exist and holes develop under the surface of the snow. Falling and injury are highly possible.

Slush snow. When the air temperature becomes warmer than the freezing point, the snow begins to melt and the water content becomes high. Slush snow absorbs water from melting snow. Slush snow is recognizable by depressions in the snow with darker or bluish snow areas. These areas show holes in the ice or an accumulation of water on the surface of the ice. Skiing on this type of snow is not advisable.

CONFIRMATION OF TEACHING POINT 1

QUESTIONS:

- Q1. What do skis slide on?
Q2. What do new snow crystals (flakes) look like?
Q3. What type of snow has the lowest moisture content?

ANTICIPATED ANSWERS:

- A1. Skis slide on the thin layer of moisture that is between the snow and the ski surface.
A2. New snow crystals (flakes) have many points and arms.
A3. Powder snow has the lowest moisture content.

Teaching Point 2

Explain, demonstrate and have the cadets select and fit cross-country ski equipment.

Time: 30 min

Method: Demonstration and Performance



For this TP it is recommended that instruction take the following format:

1. Introduce the parts and characteristics of cross-country skis.
2. Demonstrate selection and sizing of cross country ski equipment.
3. Have assistant instructors issue the cadets cross-country ski equipment, using the sizing information recorded on the cadet's Cross-Country Ski Equipment Sizing Information Form. Have the cadets form a line to receive the items in the following order:
 - a. cross-country skis,
 - b. ski boots, and
 - c. ski poles.
4. Monitor the cadets and check sizing as they practice the steps to fitting cross-country ski equipment.
5. Conduct equipment exchanges as required.
6. Label each cadet's cross-country ski equipment with gear or masking tape.

Note: Assistant instructors will be required to distribute cross-country ski equipment and monitor the cadets' performance.



Cadets have no option in the type of skis / bindings / boots that are used. Type will depend on expedition centre stores.

Cross-country skiing is a fun and challenging sport with origins dating back hundreds of years. Norwegian and Scandinavian immigrants brought the sport of cross-country skiing to North America in the late 1800s. While it was initially used as a mode of transportation for hunters, miners, and mail carriers, it has progressed into a winter sport that can be enjoyed by all ages and all fitness levels.

Cross-country skiing can be grouped into three categories:

- ski touring,
- track skiing, and
- backcountry skiing.



Ski touring. The broadest and most versatile category of cross-country skiing. Ski touring does not require groomed trails—skiers can walk out their 'backdoor' and enjoy nature in a park, through a forest, or along a country road.

SELECT CLASSIC CROSS-COUNTRY SKIS

Cross-country skiing is a sport that can be conducted with little or no training, which is what makes it so popular. It is critical that skiers have properly fitted equipment. Properly fitted equipment increases overall skiing efficiency, staves off injuries and increases personal enjoyment.

Parts of a Ski

1. **Tip.** The front of the ski.
2. **Tail.** The back of the ski.
3. **Waist.** The middle of the ski.
4. **Ski base.** The underside of the ski.
5. **Topsheet.** The upper surface of the ski.
6. **Sidewalls.** The sides of the ski.
7. **Edge.** Where the sidewall meets the ski base.

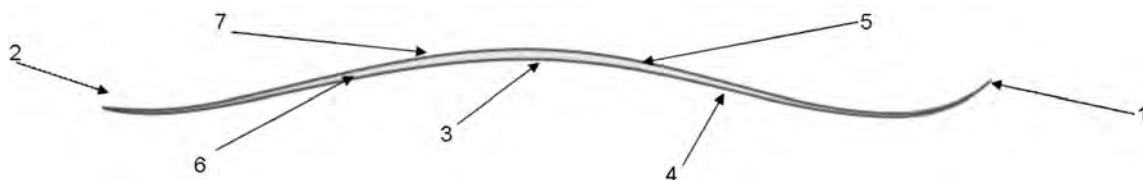



Figure 4 Parts of a Ski

Note. From *Cross-Country Skiing: Building Skills for Fun and Fitness* (p. 59), by S. Hindman, 2006, Seattle, WA: The Mountaineers Books. Copyright 2005 by The Mountaineers Books.

Characteristics of Cross-Country Skis

1. **Camber.** The arch of a ski from tip to tail as it lies ski base down on a flat surface. Camber allows a ski to be thin and light but still support the skier's weight. Camber of a ski can be manipulated to control where and how much pressure is applied to the snow along the length of the ski.



Camber can be explained by thinking about an arched bridge versus a flat bridge. The weight and pressure of an arched bridge is transferred from the middle of each span to the support piers—allowing for lighter materials to be used and the space below the arch not requiring much support. To carry the same amount of weight, a flat bridge needs to be constructed from stronger materials and supported by piers along its entire length.

2. **Width.** The width of a ski depends on the type of snow the individual is skiing on. The softer the snow, the wider the ski should be. Likewise, if skiing on machine-groomed, hard-packed trails, a narrower ski is recommended.
3. **Length.** Classic cross-country skis are typically longer than skating skis. This is because skating skis are usually used on machine-groomed, hard-packed trails and do not require the ski to float to the surface of deep snow.

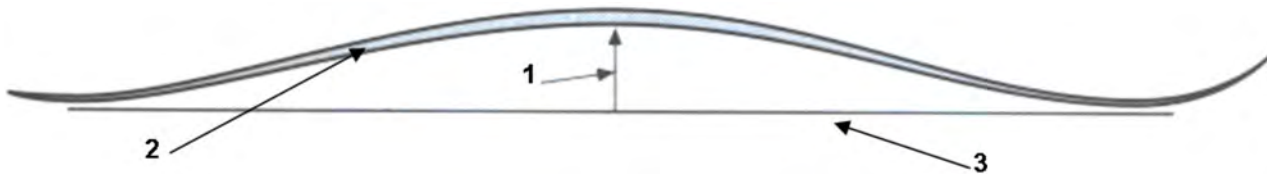



Figure 5 Characteristics of Skis

Note. From *Cross-Country Skiing: Building Skills for Fun and Fitness* (p. 59), by S. Hindman, 2006, Seattle, WA: The Mountaineers Books. Copyright 2005 by The Mountaineers Books.

Selecting Skis

The chart below is a rough guide to follow when selecting a ski length. When selecting a ski length, it is always recommended that the manufacturer's sizing chart be consulted.

| Ski Length | Carrying Capacity |
|-------------|-------------------|
| 168 cm | 90–130 lbs |
| 168, 178 cm | 130–150 lbs |
| 178, 188 cm | 150–180 lbs |
| 188 cm | 180–220 lbs |



The most common types of bindings used when cross-country skiing are:

- three-pin (75 mm), and
- system.

Three-pin bindings. Three-pin bindings work with boot soles and are shaped like a duckbill at the toe. The three pins at the front of the binding fit into three holes in the toe of the boot. A bar called a bail levers down from the upturned sides of the binding to clamp the toe of the boot sole to the ski and is held in place by a catch at the front. The duckbill that mates with the binding is 75 mm wide.

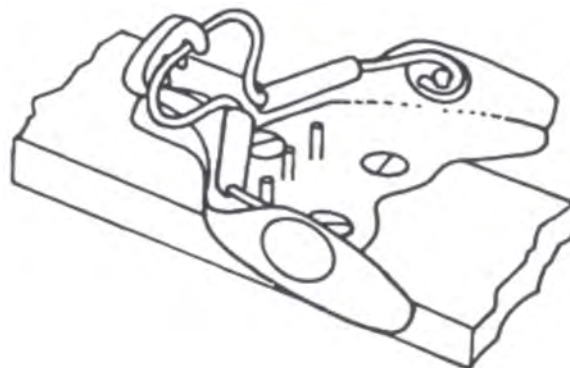

Figure 6 Three-Pin Binding

Note. From *Complete Cross-Country Skiing and Ski Touring* (2nd ed.), (p. 20), by W. J. Lederer & J. P. Wilson, 1970, Toronto, ON: George J. McLeod Ltd. Copyright 1970 by William J. Lederer and Joe Pete Wilson.

System bindings. There are two types of system bindings—Salomon Nordic System (SNS) and New Nordic Norm (NNN). They are not interchangeable. In both models, the ski boots have a deep channel in the sole and a bar beneath the toe that clips into the binding. A wide ridge mounted on the ski extends to the rear from the point where the bar mates with the binding. This ridge fits into the channel in the boot to provide side-to-side control.



Figure 7 NNN System Binding

Note. From *Back Country Ski Bindings* by In My View... Things as I see Them, 2009. Retrieved May 1, 2009, from http://1.bp.blogspot.com/_UFDhrGObeFc/SWWjkvg_8KI/AAAAAAAAArM/qmVXzDiE1ek/s400/nnnBCbindings.jpg

SELECT SKI BOOTS

Skis are guided and controlled through the boots, so it is important that they fit well. Boots are made from a variety of materials from all leather, to modelled plastic to a combination of materials. Lighter boots provide more freedom but offer less support. Heavier boots provide more support but usually restrict movement and are harder to fit. Boots that are too tight / loose may cause the skier incredible discomfort—resulting in blisters, frost bite, a twisted ankle, etc.

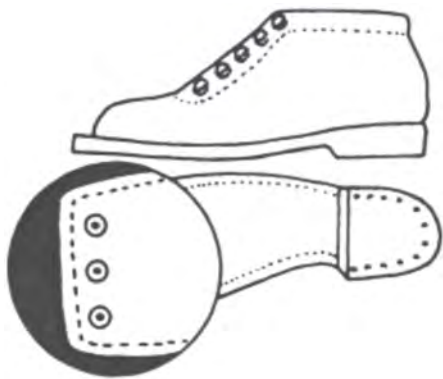

Figure 8 Three-Pin Binding Boots

Note. From *Complete Cross-Country Skiing and Ski Touring* (2nd ed.) (p. 23), by W.J. Lederer & J.P. Wilson, 1970, Toronto, ON: George J. McLeod Ltd. Copyright 1970 by William J. Lederer and Joe Pete Wilson.



Figure 9 NNN Binding Boots

Note. From *Back Country Ski Bindings* by In My View... Things as I see Them, 2009. Retrieved May 1, 2009, from http://1.bp.blogspot.com/_UFDhrGObeFc/SWWjkgv_8KI/AAAAAAAAArM/qmVXzDiE1ek/s400/nnnBCbindings.jpg

To check the fit of boots, slide the foot as far forward as it will go when standing up. With the toes just touching the front of the boot, there should be just enough room to slide the forefinger behind the heel.

SELECT SKI POLES

Ski poles are an integral part of cross-country skiing. Most techniques in cross-country skiing require the skier to not only use their skis, but their arms (poles) as well. Ski poles help the skier maintain balance while climbing inclines, when going downhill and when going forward.



Telescopic poles allow for adjustments for all sizes of skiers.

Parts of a Ski Pole

Ski poles have a variety of parts, they are:

1. **Basket.** Keeps the shaft of the ski pole from becoming fully submersed in the snow.
2. **Tip.** Allows the pole to dig into snow, ice and dirt so the skier gets a strong push.
3. **Shaft.** Is the main part of the pole—should be made from a strong material so it does not bend under pressure.
4. **Handle.** The handle is ergonomically designed for the comfort the skier.
5. **Strap.** Ensures that the pole moves with the skier.

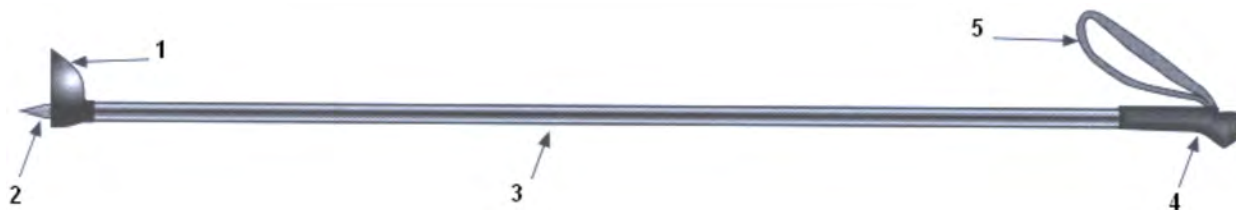

Figure 10 Parts of a Ski Pole

Note. From *Cross-Country Skiing: Building Skills for Fun and Fitness* (p. 73), by S. Hindman, 2006, Seattle, WA: The Mountaineers Books. Copyright 2005 by The Mountaineers Books.

Characteristics of Ski Poles

A good ski pole should have the following characteristics:

- a medium-sized basket (the deeper the snow, the larger the basket should be),
- an adjustable strap,
- a weight distribution that concentrates the weight near the handle, and
- minimal bend when pressure is placed on it.

Sizing Ski Poles

Sizing ski poles to fit a cross-country skier requires the skier to stand up straight and hold the pole close to the body. The pole, when held upright, should come to a height in-between the top of the chest and the armpit.

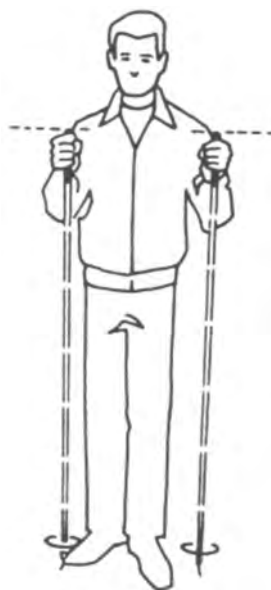

Figure 11 Sizing Ski Poles

Note. From *Complete Cross-Country Skiing and Ski Touring* (2nd ed.), (p. 26), by W. J. Lederer & J. P. Wilson, 1970, Toronto, ON: George J. McLeod Ltd. Copyright 1970 by William J. Lederer and Joe Pete Wilson.

FIT CROSS-COUNTRY SKI EQUIPMENT

The following process should be used to fit cross-country ski equipment:

1. Put on ski boots.
2. Adjust poles to proper size.
3. Find a flat spot where the snow is firm.
4. Place the skis on the snow side by side (about 30 cm [1 foot] apart).
5. Place poles into the snow, within reach, one on each side of the skis.
6. Identify the type of binding being used (three-pin or system).



Tell cadets what bindings are being used.

7. Attach the ski boot to the ski with:
 - a. a three-pin binding by:
 - (1) opening the bail (the bar that levers down from the upturned sides of the binding to clamp the toe of the boot sole to the ski);
 - (2) brushing the snow off the bottom of the right (left) ski boot and the right (left) ski binding;
 - (3) sliding the square toe of the boot into the toe piece of the binding beneath the open bail;
 - (4) pressing down with the ball of the foot to push the three pins of the binding into the ski boot (ensure that the pins are aligned before pressing down);
 - (5) closing the bail by pushing down and clamping it to the plate; and
 - (6) completing the process again for the other ski; and

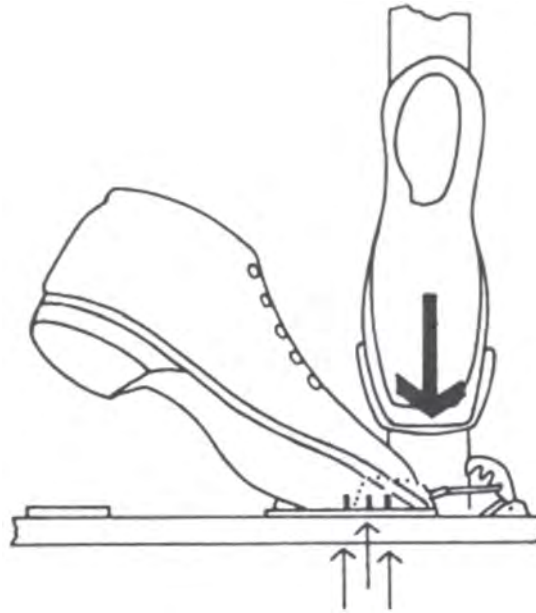

Figure 12 Attaching a Ski Boot to a Three-Pin Binding

Note. From *Complete Cross-Country Skiing and Ski Touring* (2nd ed.) (p. 36), by W.J. Lederer & J.P. Wilson, 1970, Toronto, ON: George J. McLeod Ltd. Copyright 1970 by William J. Lederer and Joe Pete Wilson.



There is a left and a right ski when using three-pin bindings. The part of the binding which flares out is always on the outside.

b. a system binding by:

- (1) pulling up on the toe piece to open the binding;



Some system bindings are automatic and do not require the binding to be opened. If the toe piece does not pull up, then it is automatic.

- (2) brushing the snow off the bottom of the right (left) ski boot and the right (left) ski binding;
 - (3) placing the bar located on the bottom of the toe piece of the ski boot into the slot on the binding;
 - (4) pushing down with the ball of the foot to force the bar into the slot;
 - (5) closing the toe piece if manual bindings are being used or listening for the click of the binding locking if automatic bindings are being used; and
 - (6) completing the process again for the other ski.
8. Grasp the ski poles by moving each hand up the shaft of the pole and into the strap from the bottom so that the thumb rests over the strap.



Figure 13 Grasping the Ski Pole

Note. From *Cross-Country Skiing: Building Skills for Fun and Fitness* (p. 41), by S. Hindman, 2006, Seattle, WA: The Mountaineers Books. Copyright 2005 by The Mountaineers Books.

CONFIRMATION OF TEACHING POINT 2

The cadets' fitting of cross-country ski equipment will serve as the confirmation of this TP.

Teaching Point 3

Explain, demonstrate and have the cadets practice classic cross-country ski techniques along a route.

Time: 220 min

Method: Demonstration and Performance



The purpose of this TP is to provide cadets instruction on cross-country ski techniques and once a level of proficiency has been established in each skill, for the cadets to travel a designated route for 6–10 km.

For this skill TP it is recommended that instruction take the following format:

1. Explain and demonstrate each skill while the cadets observe.
2. Explain and demonstrate the steps to complete each skill while the cadets observe. Monitor the cadets as they practice each step.
3. Monitor the cadets' performance as they practice each skill.

Assistant instructors will be required to monitor the cadets' performance.



The ideal area for learning cross-country ski techniques is relatively flat, with a gentle hill in close proximity. It is better to have packed snow, rather than deep snow or ice.

CROSS-COUNTRY SKI TECHNIQUES

Cross-country skiing is a sport that requires very little skill. Anybody can put on a pair of skis and play in the snow. Understanding stroke mechanics and techniques will, however, make skiing more efficient and enjoyable.



Having the correct body position when cross-country skiing is very important. When in the proper cross-country ski position, the skier is in a relaxed half-sitting position. The feet are flat, knees slightly bent, the head should be up, and the poles lightly grasped.

Falling Down

No matter how good a cross-country skier a person is, there is always a chance that they will fall down. It is not the falling that is difficult when cross-country skiing. Getting up after the fall is what most people struggle with.

If a skier feels like they have lost their balance / they are going to fall:

1. Check the area for rocks or tree stumps to avoid, if possible.
2. Sit down to one side or the other of the skis.
3. Keep legs below the rest of the body.
4. Dig the skis into the snow to stop any forward momentum.



It is dangerous for a skier to fall forward onto their knees. This could injure the skier's knees / ankles. As well, when falling forward, a person generally sticks their arms out to break the fall—this could result in an injury.

To get up after a fall:

1. Roll onto their back and stick their limbs, skis and poles into the air to untangle them.
2. Place skis below the body.
3. Keep legs extended.
4. Slide hips towards the tips of the skis (if on a hill stop just beside the skis, if on flat ground place chest on skis).
5. Come to one knee (plant poles to assist with coming to one knee).
6. Stand up.



Step 1



Step 2



Step 3



Step 4



Step 5



Step 6

Figure 14 Steps to Getting Up After Falling Down

Note. From *Cross-Country Skiing: Building Skills for Fun and Fitness* (pp. 36–37), by S. Hindman, 2006, Seattle, WA: The Mountaineers Books. Copyright 2005 by The Mountaineers Books.

Stopping

For their own safety and for the safety of those around them, it is extremely important that cross-country skiers are able to slow down and stop themselves on flat ground and on hills. The principles for both are the same and require the skier have constant control of their body and their skis. A cross-country ski glides most effectively when it is flat on the ski base. A ski begins to lose forward momentum as soon as it is tipped to either edge. Therefore to stop, the skier must tip the ski to the edge—this is called edging.



Edging can be done when the skis are parallel or when they are in a wedge position—tips together, tails spread apart to form an 'A'.



The wedge position is also sometimes referred to as the snowplow position. Some may be more familiar with this term as it is also used in downhill skiing.

There are two types of wedging:

- the half wedge, and
- the full wedge.

To slow down / stop using the half wedge:

1. Decide which ski they are going to move into the half wedge position.
2. Keep one ski parallel.
3. Move into the half wedge position by:
 - a. bringing the knees together;
 - b. keeping the tips of the skis together; and
 - c. moving the tail of the desired ski outward by pushing the heel out and the toes inward.
4. Angle the inside edge of the wedged ski into the snow by rolling the ankle inward (the more the edge is angled into the snow, the faster the skier will slow down / stop).



Figure 15 Half Wedge

Note. From *Cross-Country Skiing: Building Skills for Fun and Fitness* (p. 50), by S. Hindman, 2006, Seattle, WA: The Mountaineers Books. Copyright 2005 by The Mountaineers Books.

To slow down / stop using the full wedge:

1. Sink into a crouch.
2. Bring the knees together and point them toward the tips of the skis.
3. Keep the tips of the skis together (but not touching).
4. Move the tails of the skis outward by pushing the heels outward and the toes inward.
5. Angle the inside edges of the wedged skis into the snow by rolling the ankles inwards (the more the edge is angled into the snow, the faster the skier will slow down / stop).

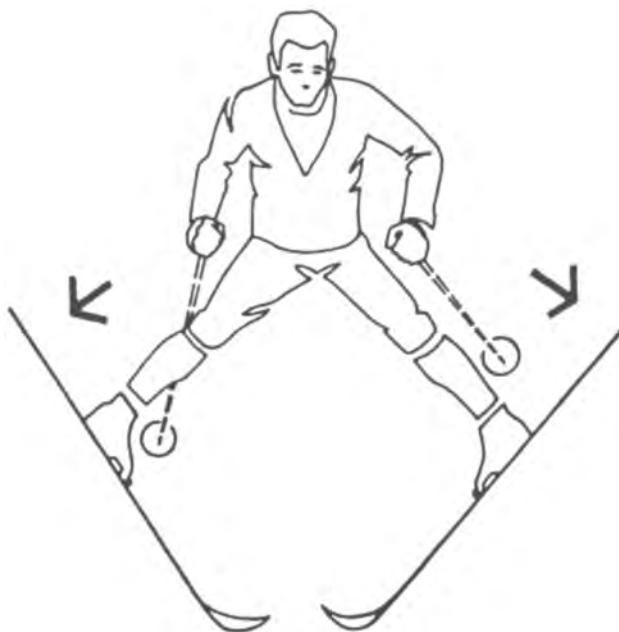

Figure 16 Full Wedge

Note. From *Complete Cross-Country Skiing and Ski Touring* (2nd ed.), (p. 52), by W. J. Lederer & J. P. Wilson, 1970, Toronto, ON: George J. McLeod Ltd. Copyright 1970 by William J. Lederer and Joe Pete Wilson.

Changing Direction

Whenever on cross-country skis there is always a requirement for the skier to change direction of travel. It is a fairly simple process that requires practice in order to perfect it.



For new cross-country skiers, it is recommended that they stop before attempting to change direction. Once they become more proficient, they may employ these skills while moving.

Changing direction can be carried out by picking up the tip, the tail or the entire ski, one at a time, and moving it toward the new direction of travel—then repeating the process with the other ski. Depending on the degree of the turn, the skier may need to complete this process a number of times before reaching the desired direction.

To change direction:

1. Assume the half-sitting position.

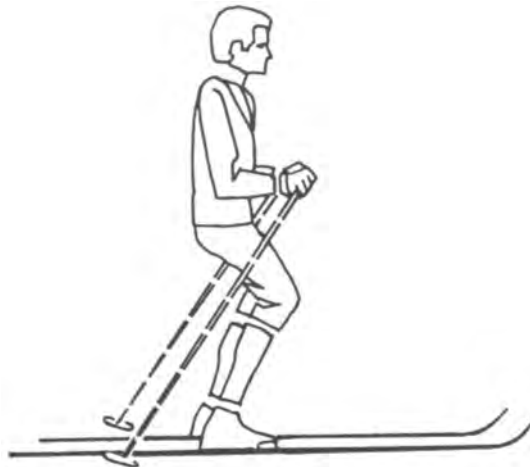

Figure 17 Half Sitting Position

Note. From Complete Cross-Country Skiing and Ski Touring (2nd ed.), (p. 40), by W. J. Lederer & J. P. Wilson, 1970, Toronto, ON: George J. McLeod Ltd. Copyright 1970 by William J. Lederer and Joe Pete Wilson.

2. Move the left (right) ski forward until left (right) boot toe is just ahead of the right (left) boot toe.
3. Lift the tip of the left (right) ski about 30 cm (1 foot) off the ground.
4. Move the lifted ski slightly to the left (right), about an arc of 30 degrees.
5. Place the left (right) ski on the ground and transfer the weight to it.
6. Bring the right ski around, in the same manner, to meet the left ski.
7. Repeat Steps 2–6 until facing the desired direction.



Figure 18 Changing Direction

Note. From Complete Cross-Country Skiing and Ski Touring (2nd ed.), (pp. 42–43), by W. J. Lederer & J. P. Wilson, 1970, Toronto, ON: George J. McLeod Ltd. Copyright 1970 by William J. Lederer and Joe Pete Wilson.

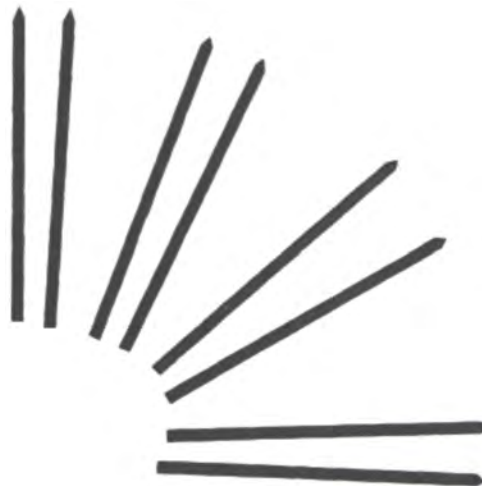

Figure 19 Ski Tracks When Changing Direction

Note. From Complete Cross-Country Skiing and Ski Touring (2nd ed.), (pp. 42–43), by W. J. Lederer & J. P. Wilson, 1970, Toronto, ON: George J. McLeod Ltd. Copyright 1970 by William J. Lederer and Joe Pete Wilson.



To pick up the tip of the ski, the skier has to:

1. lift their toes so they come up to the top of the ski boot;
2. flex their foot up to their shin; and
3. lift their knee toward their chest.

To pick up the tail of the ski, the skier has to:

1. curl their toes down against the sole of their ski boot;
2. bring their heel to their butt; and
3. keep their knees close together.



Moving forward when cross-country skiing requires the skier to incorporate balance, glide, grip, rhythm, and poling.

Balance. To maintain balance, skiers have to constantly adjust their centre of gravity with their hips and upper body centred over their skis as they glide.

Glide. Moving the body forward from the ankles puts the body in motion and allows the skier to 'keep up' with their feet and glide more with each stride.

Grip. Glide can not occur without good grip. Cross-country skis have a grip zone centred beneath the ball of the foot in the middle of the ski. This grip zone makes the ski stick to the snow when pressure is applied by the skiers foot during the push of each stride.

Rhythm. Skiers must develop a slow and steady rhythm to their stride, moving effortlessly from one ski to the next. For some, this is a difficult concept, but can be developed with practice.

Poling

There are two different poling techniques that a cross-country skier can use, to include:

- **Diagonal poling.** Uses the pole opposite of the gliding ski to create additional forward motion of the skier. The skier plants and pushes with only one pole at a time; and
- **Double poling.** Simultaneously uses both poles to propel the skis and skier forward. Used to go down gentle slopes in order to gain speed and on flats when the skier is not using the diagonal stride.

The following poling principles should be considered:

- Poles can not push forward unless they are angled to the rear.
- The skier gets a stronger push when their arms are bent rather than straight.
- Pushing the pole back rather than down converts more of the skiers energy into forward motion at the end of a stroke.
- The skier should use their body weight, not just their arms—pull with their core, to move forward.
- The skier should concentrate on pushing with their poles rather than bringing them forward.

To diagonal pole:

1. Assume the half-sitting position.
2. Move the left ski so that it is forward of the right ski.
3. Lean forward.
4. Transfer the weight to the left ski.
5. Plant the right pole just ahead of the left ski boot (to the right of the path that the right ski will take) with the handle ahead of the basket.
6. Simultaneously push off with the left ski and push the right pole back (ensure that core strength is used, not just the arms).
7. Recover by lifting the left pole.
8. Repeat the process with the other pole.



Figure 20 Diagonal Poling / Diagonal Stride

Note. From *Cross-Country Skiing: Building Skills for Fun and Fitness* (p. 146), by S. Hindman, 2006, Seattle, WA: The Mountaineers Books. Copyright 2005 by The Mountaineers Books.

To double pole:

1. Assume the half-sitting position.
2. Keep the elbows close into the body.
3. Round the back;
4. Lean forward.
5. Plant the poles just ahead of the ski boots (handles should be ahead of the baskets).

6. Contract the stomach muscles.
7. Push forward and extend the arms back.
8. Stand up.
9. Allow the arms and poles to swing forward.
10. Prepare for the next pole plant.



Figure 21 Double Poling

Note. From *Cross-Country Skiing: Building Skills for Fun and Fitness* (p. 43), by S. Hindman, 2006, Seattle, WA: The Mountaineers Books. Copyright 2005 by The Mountaineers Books.

Executing the Diagonal Stride

When cross-country skiing, the most frequently used way to move forward is by executing the diagonal stride. It is called the diagonal stride because the right leg and the left pole (and vice versa) work together to move the skier forward. The diagonal stride technique makes for greater forward thrust and easy balance.



The body movement when executing the diagonal stride is the same as marching.

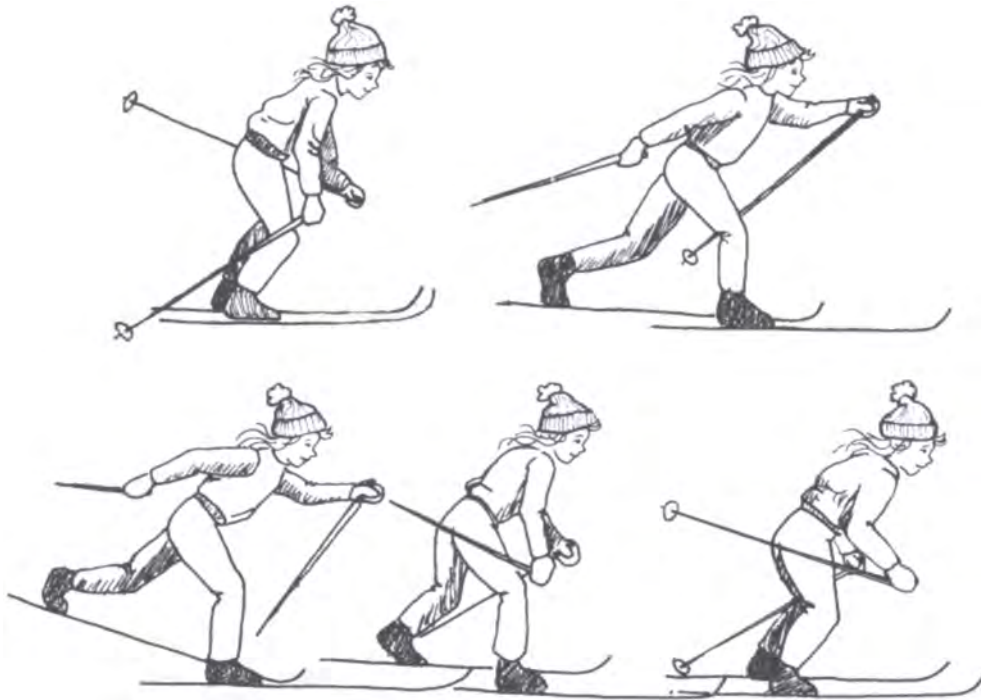

Figure 22 Diagonal Stride Technique

Note. From *Ski Games: A Fun-Filled Approach to Teaching Nordic and Alpine Skiing* (p. 92), by L. Gullion, 1990, Champaign, IL: Leisure Press. Copyright 1990 by Laurie Gullion.



The steps to execute the diagonal stride are the same as those to diagonal pole.

Ascending Hills

The biggest factor that affects a skier's ability to traverse up a hill is grip. Grip comes from the skier staying over their feet and pushing their skies straight down into the snow. There are two different techniques that can be used to ascend hills:

Herringbone. A technique used to climb straight up a hill on the inside edges of the skis with the tips farther apart than the tails. A skier using the herringbone technique to ascend a hill leaves an imprint that resembles the skeleton of a fish.

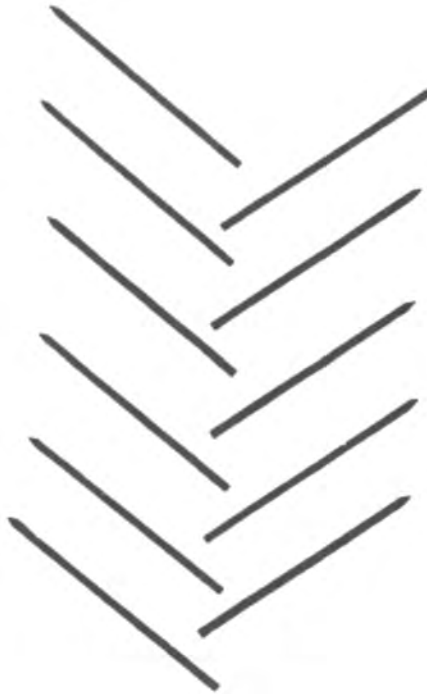

Figure 23 Herringbone Tracks

Note. From *Complete Cross-Country Skiing and Ski Touring* (2nd ed.), (p. 90), by W. J. Lederer & J. P. Wilson, 1970, Toronto, ON: George J. McLeod Ltd. Copyright 1970 by William J. Lederer and Joe Pete Wilson.

To use the herringbone technique to ascend a hill:

1. Place skis into a 'V' formation (the tails should be close together).
2. Turn the legs out.
3. Transfer the weight onto the left (right) foot.
4. Lift up the right (left) ski and move it forward.
5. Plant the left (right) pole behind the left (right) ski.
6. Repeat until reaching the top of the hill.



Figure 24 Herringbone Technique

Note. From *Complete Cross-Country Skiing and Ski Touring* (2nd ed.), (p. 91), by W. J. Lederer & J. P. Wilson, 1970, Toronto, ON: George J. McLeod Ltd. Copyright 1970 by William J. Lederer and Joe Pete Wilson.



On steep hills, the skier has to dig in the edges of their skis to maintain grip and position.

Side step. Is a technique where the skier places their skis horizontal to the hill and moves upward using short side steps. A skier uses the side step when a hill gets too steep, the snow becomes too deep, or the herringbone becomes too tiring.

To use the side step technique to ascend a hill:

1. Place the skis horizontal to the hill to be ascended.
2. Keep the body upright and centred over the skis.
3. Move the torso sideways and up the hill.
4. Plant the pole ahead of them.
5. Lift and move the ski up.
6. Dig the edge of the ski into the snow.
7. Repeat until the top of the hill is reached.

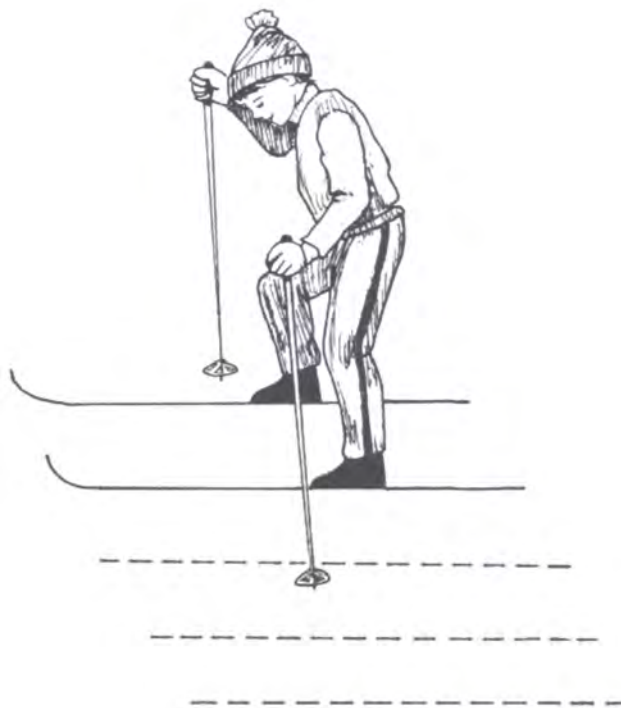

Figure 25 Side Step Technique

Note. From *Ski Games: A Fun-Filled Approach to Teaching Nordic and Alpine Skiing* (p. 100), by L. Gullion, 1990, Champaign, IL: Leisure Press. Copyright 1990 by Laurie Gullion.

Descend a Hill

The most important factors to descending a hill safely are balance and control. A skier should never just turn their skis downhill and go—the descent must always be controlled. In other words, the skier must always be ready to slow down or stop.

When descending a hill:

1. Adopt the half-sitting position.
2. Keep the head up and look forward.
3. Move the skis so that they are just under shoulder width apart.
4. Ensure the feet are flat on the skis.
5. Look down the slope to make sure there are no obstacles.
6. Drop the hands to thigh level.
7. Hold the pole shafts toward the back, keeping the baskets off the snow.
8. Glide down the hill.
9. Slow down / stop by executing a full wedge.

ACTIVITY

Time: 120 min

OBJECTIVE

The objective of this activity is to have the cadets, in teams of no more than six, ski along a route for 6–10 km with an expedition field pack to practice cross-country ski techniques.

RESOURCES

- Personal expedition equipment,
- Personal cross-country ski equipment,
- Group cross-country ski equipment, and
- Water carrier (one per cadet).

ACTIVITY LAYOUT

Nil.

ACTIVITY INSTRUCTIONS

1. Conduct a briefing to include an explanation of:
 - a. the objectives and importance of the activity,
 - b. the resources that may be required to perform the activity, and
 - c. any safety guidelines that must be followed while performing the activity.
2. Have the cadets retrieve their cross-country ski equipment and expedition field packs.
3. Have the cadets, in teams of no more than six, cross-country ski with an expedition field pack, following the designated route for a distance of 6–10 km during an expedition to practice:
 - a. falling;
 - b. stopping using:
 - (1) the half wedge, and
 - (2) the full wedge;
 - c. changing direction;
 - d. poling by:
 - (1) diagonal poling, and
 - (2) double poling;
 - e. executing the diagonal stride;

- f. ascending hills by:
 - (1) employing the herringbone technique; and
 - (2) employing the side stepping technique; and
 - g. descending hills.
4. Upon arrival at the end point, have the cadets remove, clean and inspect their cross-country ski equipment for damage and then store / return all equipment.
 5. Conduct a debriefing by asking the cadets:
 - a. how they felt about the activity;
 - b. how they felt their team worked together;
 - c. what portion of the activity challenged them the most;
 - d. how their teammates assisted them when they were challenged;
 - e. if there are any specific examples of when their team bonded;
 - f. how the team made decisions;
 - g. whether or not all team members ideas / suggestions were considered; and
 - h. what they would do as a leader of this type of activity to ensure their subordinates enjoyed the experience.

SAFETY

- The Team Instructor(s) (TI) must be in sight or sound of the team at all times.
- In areas of complex / technical terrain, TI(s) will demonstrate requisite skills as required.
- Teams will travel separately on the same trail.
- There will be a minimum of 500 m between teams at all times.
- Cadets must travel in single file at all times.
- Cadets must have at least 1 L of water.
- Water resupply points will be located along the route.
- Meals will be provided at a predetermined location(s) and detailed in the route instructions.

CONFIRMATION OF TEACHING POINT 3

The cadets' participation in the activity will serve as the confirmation of this TP.

END OF LESSON CONFIRMATION

The cadets' participation in cross-country skiing along a route will serve as the confirmation of this lesson.

CONCLUSION

HOMEWORK / READING / PRACTICE

Nil.

METHOD OF EVALUATION

This lesson is assessed IAW A-CR-CCP-704/PG-001, *Gold Star Qualification Standard and Plan*, Chapter 3, Annex B, 426 PC.

CLOSING STATEMENT

Skiing is a fun and challenging mode of travel that can be used during winter expeditions. Being aware of the different types and characteristics of snow and ice helps ensure the safety of all expedition participants. Possessing the ability to execute classic cross-country ski techniques makes the experience more enjoyable and the expedition more efficient.

INSTRUCTOR NOTES / REMARKS

Expedition centres are required to select two dynamic modes of travel from EO M426.02a (Paddle a Canoe), EO M426.02b (Ride a Mountain Bike), EO M426.02c (Hike Along a Route), EO M426.02d (Snowshoe Along a Route) and EO M426.02e (Ski Along a Route) to incorporate into the expedition training.

This EO has been allocated nine periods in the overall course period allocation. Each expedition centre may adjust this allocation to reflect the choice of activities, facilities and available resources at the expedition centre.

Upon arrival at the expedition centre, cadets will be divided into teams. Cadets will be given an opportunity to navigate and lead peers. These teams will remain the same for the duration of the weekend.

Total distance for the cross-country ski route may be adjusted depending on trail availability and skill level of participants.

IAW A-CR-CCP-951/PT-002, *Royal Canadian Army Cadets Adventure Training Safety Standards*:

1. the following personal cross-country ski equipment is required when cross-country skiing:
 - a. ski boots,
 - b. skis,
 - c. poles,
 - d. appropriate cold-weather clothing, and
 - e. a whistle;
2. the following group cross-country ski equipment is required when cross-country skiing:
 - a. topographical / trail map of area as required,
 - b. compass,
 - c. first aid kit,
 - d. communication device (eg, cellular phone or hand-held radio),

- e. GPS receiver, and
 - f. cold weather emergency kit appropriate to the activity; and
3. weather must be continuously assessed. If the temperature falls below -20°C (with the wind-chill factor calculated in), cadets must be brought inside.

REFERENCES

C2-004 ISBN 1-896713-00-9 Tawrell, P. (1996). *Camping and wilderness survival: The ultimate outdoors book*. Green Valley, ON: Author.

C2-237 ISBN 978-0-89886-862-3 Hindman, S. (2005). *Cross-country skiing: Building skills for fun and fitness*. Seattle, WA: The Mountaineers Books.

C2-247 ISBN 978-0-393-08734-5 Lederer, W. J., & Wilson, J. P. (1970). *Complete cross-country skiing and ski touring*. (2nd ed.). Toronto, ON: George J. McLeod Ltd.

THIS PAGE INTENTIONALLY LEFT BLANK

CROSS-COUNTRY SKI EQUIPMENT SIZING INFORMATION FORM

| | |
|-------------------------|-------------------------|
| Name: _____ | Name: _____ |
| Team: _____ | Team: _____ |
| Height: _____ | Height: _____ |
| Weight: _____ | Weight: _____ |
| Shoe Size: _____ | Shoe Size: _____ |
| Name: _____ | Name: _____ |
| Team: _____ | Team: _____ |
| Height: _____ | Height: _____ |
| Weight: _____ | Weight: _____ |
| Shoe Size: _____ | Shoe Size: _____ |

THIS PAGE INTENTIONALLY LEFT BLANK